

CHEMISTRY Part I

Class XII

NCERT



Chemistry

Part I

Textbook for Class XII

CONTENTS

FOREWORD	v
PREFACE	vii
Unit 1 The Solid State	1
1.1 General Characteristics of Solid State	2
1.2 Amorphous and Crystalline Solids	2
1.3 Classification of Crystalline Solids	4
1.4 Crystal Lattices and Unit Cells	7
1.5 Number of Atoms in a Unit Cell	10
1.6 Close-Packed Structures	12
1.7 Packing Efficiency	18
1.8 Calculations Involving Unit Cell Dimensions	20
1.9 Imperfections in Solids	22
1.10 Electrical Properties	24
1.11 Magnetic Properties	27
Unit 2 Solutions	33
2.1 Types of Solutions	33
2.2 Expressing Concentration of Solutions	34
2.3 Solubility	37
2.4 Vapour Pressure of Liquid Solutions	41
2.5 Ideal and Non-ideal Solutions	45
2.6 Colligative Properties and Determination of Molar Mass	47
2.7 Abnormal Molar Masses	55
Unit 3 Electrochemistry	63
3.1 Electrochemical Cells	64
3.2 Galvanic Cells	65
3.3 Nernst Equation	68
3.4 Conductance of Electrolytic Solutions	73
3.5 Electrolytic Cells and Electrolysis	83
3.6 Batteries	86

3.7	Fuel Cells	88
3.8	Corrosion	89
Unit 4	Chemical Kinetics	93
4.1	Rate of a Chemical Reaction	94
4.2	Factors Influencing Rate of a Reaction	98
4.3	Integrated Rate Equations	103
4.4	Pseudo First Order Reaction	110
4.5	Temperature Dependence of the Rate of a Reaction	111
4.6	Collision Theory of Chemical Reactions	115
Unit 5	Surface Chemistry	121
5.1	Adsorption	122
5.2	Catalysis	127
5.3	Colloids	134
5.4	Classification of Colloids	134
5.5	Emulsions	143
5.6	Colloids Around Us	143
Unit 6	General Principles and Processes of Isolation of Elements	147
6.1	Occurrence of Metals	148
6.2	Concentration of Ores	148
6.3	Extraction of Crude Metal from Concentrated Ore	150
6.4	Thermodynamic Principles of Metallurgy	151
6.5	Electrochemical Principles of Metallurgy	157
6.6	Oxidation Reduction	158
6.7	Refining	159
6.8	Uses of Aluminium, Copper, Zinc and Iron	162
Unit 7	The p-Block Elements	165
7.1	Group 15 Elements	165
7.2	Dinitrogen	169
7.3	Ammonia	170
7.4	Oxides of Nitrogen	172
7.5	Nitric Acid	173
7.6	Phosphorus – Allotropic Forms	175
7.7	Phosphine	176
7.8	Phosphorus Halides	177
7.9	Oxoacids of Phosphorus	178

7.10	Group 16 Elements	180
7.11	Dioxygen	184
7.12	Simple Oxides	185
7.13	Ozone	185
7.14	Sulphur – Allotropic Forms	187
7.15	Sulphur Dioxide	188
7.16	Oxoacids of Sulphur	189
7.17	Sulphuric Acid	189
7.18	Group 17 Elements	192
7.19	Chlorine	197
7.20	Hydrogen Chloride	198
7.21	Oxoacids of Halogens	199
7.22	Interhalogen Compounds	200
7.23	Group 18 Elements	202
Unit 8	The d-and f-Block Elements	209
8.1	Position in the Periodic Table	210
8.2	Electronic Configurations of the d-Block Elements	210
8.3	General Properties of the Transition Elements (d-Block)	212
8.4	Some important Compounds of Transition Elements	224
8.5	The Lanthanoids	227
8.6	The Actinoids	230
8.7	Some Applications of d-and f-Block Elements	232
Unit 9	Coordination Compounds	237
9.1	Werner's Theory of Coordination Compounds	237
9.2	Definition of Some Important Terms Pertaining to Coordination Compounds	240
9.3	Nomenclature of Coordination Compounds	241
9.4	Isomerism in Coordination Compounds	244
9.5	Bonding in Coordination Compounds	247
9.6	Bonding in Metal Carbonyls	254
9.7	Stability of Coordination Compounds	255
9.8	Importance and Applications of Coordination Compounds	256
Appendices		261
Answers to Some Questions in Exercises		274
Index		278

Objectives

After studying this Unit, you will be able to

- describe general characteristics of solid state;
- distinguish between amorphous and crystalline solids;
- classify crystalline solids on the basis of the nature of binding forces;
- define crystal lattice and unit cell;
- explain close packing of particles;
- describe different types of voids and close packed structures;
- calculate the packing efficiency of different types of cubic unit cells;
- correlate the density of a substance with its unit cell properties;
- describe the imperfections in solids and their effect on properties;
- correlate the electrical and magnetic properties of solids and their structure.

Unit

1

The Solid State

The vast majority of solid substances like high temperature superconductors, biocompatible plastics, silicon chips, etc. are destined to play an ever expanding role in future development of science.

We are mostly surrounded by solids and we use them more often than liquids and gases. For different applications we need solids with widely different properties. These properties depend upon the nature of constituent particles and the binding forces operating between them. Therefore, study of the structure of solids is important. The correlation between structure and properties helps in discovering new solid materials with desired properties like high temperature superconductors, magnetic materials, biodegradable polymers for packaging, biocompliant solids for surgical implants, etc.

From our earlier studies, we know that liquids and gases are called *fluids* because of their ability to flow. The fluidity in both of these states is due to the fact that the molecules are free to move about. On the contrary, the constituent particles in solids have fixed positions and can only oscillate about their mean positions. This explains the rigidity in solids. In crystalline solids, the constituent particles are arranged in regular patterns.

In this Unit, we shall discuss different possible arrangements of particles resulting in several types of structures. The correlation between the nature of interactions within the constituent particles and several properties of solids will also be explored. How these properties get modified due to the structural imperfections or by the presence of impurities in minute amounts would also be discussed.

11 General Characteristics of Solid State

In Class XI you have learnt that matter can exist in three states namely, solid, liquid and gas. Under a given set of conditions of temperature and pressure, which of these would be the most stable state of a given substance depends upon the net effect of two opposing factors. Intermolecular forces tend to keep the molecules (or atoms or ions) closer, whereas thermal energy tends to keep them apart by making them move faster. At sufficiently low temperature, the thermal energy is low and intermolecular forces bring them so close that they cling to one another and occupy fixed positions. These can still oscillate about their mean positions and the substance exists in solid state. The following are the characteristic properties of the solid state:

- (i) They have definite mass, volume and shape.
- (ii) Intermolecular distances are short.
- (iii) Intermolecular forces are strong.
- (iv) Their constituent particles (atoms, molecules or ions) have fixed positions and can only oscillate about their mean positions.
- (v) They are incompressible and rigid.

12 Amorphous and Crystalline Solids

Solids can be classified as *crystalline* or *amorphous* on the basis of the nature of order present in the arrangement of their constituent particles. A crystalline solid usually consists of a large number of small crystals, each of them having a definite characteristic geometrical shape. In a crystal, the arrangement of constituent particles (atoms, molecules or ions) is ordered. It has long range order which means that there is a regular pattern of arrangement of particles which repeats itself periodically over the entire crystal. Sodium chloride and quartz are typical examples of crystalline solids. An amorphous solid (Greek *amorphos* = no form) consists of particles of irregular shape. The arrangement of constituent particles (atoms, molecules or ions) in such a solid has only *short range order*. In such an arrangement, a regular and periodically repeating pattern is observed over

short distances only. Such portions are scattered and in between the arrangement is disordered. The structures of quartz (crystalline) and quartz glass (amorphous) are shown in Fig. 1.1 (a) and (b) respectively. While the two structures are almost identical, yet in the case of amorphous quartz glass there is no *long range order*. The structure of amorphous solids is similar to that of liquids. Glass, rubber and plastics are typical examples of amorphous solids. Due to the differences in the arrangement of the constituent particles, the two types of solids differ in their properties.

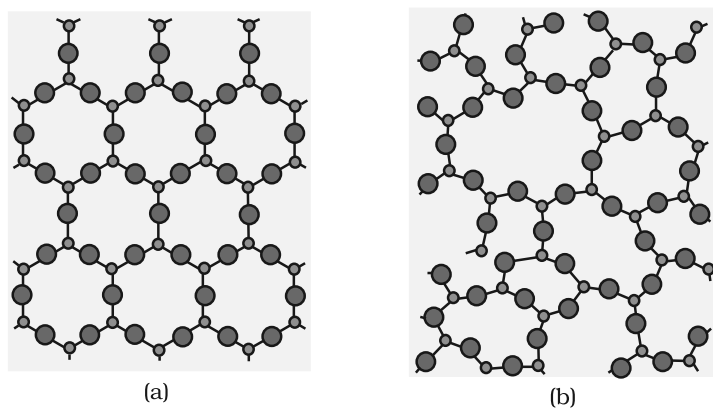

Fig. 1.1: Two dimensional structure of (a) quartz and (b) quartz glass

Crystalline solids have a sharp melting point. On the other hand, amorphous solids soften over a range of temperature and can be moulded and blown into various shapes. On heating they become crystalline at some temperature. Some glass objects from ancient civilisations are found to become milky in appearance because of some crystallisation. Like liquids, amorphous solids have a tendency to flow, though very slowly. Therefore, sometimes these are called *pseudo solids* or *super cooled liquids*. Glass panes fixed to windows or doors of old buildings are invariably found to be slightly thicker at the bottom than at the top. This is because the glass flows down very slowly and makes the bottom portion slightly thicker.

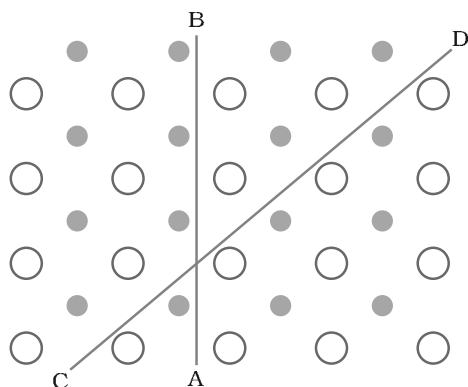

Fig. 1.2: Anisotropy in crystals is due to different arrangement of particles along different directions.

Crystalline solids are *anisotropic* in nature, that is, some of their physical properties like electrical resistance or refractive index show different values when measured along different directions in the same crystals. This arises from different arrangement of particles in different directions. This is illustrated in Fig. 1.2. Since the arrangement of particles is different along different directions, the value of same physical property is found to be different along each direction.

Amorphous solids on the other hand are *isotropic* in nature. It is because there is no *long range* order in them and arrangement is irregular along all the directions. Therefore, value of any physical property would be same along any direction. These differences are summarised in Table 1.1.

Table 1.1: Distinction between Crystalline and Amorphous Solids

Property	Crystalline solids	Amorphous solids
Shape	Definite characteristic geometrical shape	Irregular shape
Melting point	Melt at a sharp and characteristic temperature	Gradually soften over a range of temperature
Cleavage property	When cut with a sharp edged tool, they split into two pieces and the newly generated surfaces are plain and smooth	When cut with a sharp edged tool, they cut into two pieces with irregular surfaces
Heat of fusion	They have a definite and characteristic heat of fusion	They do not have definite heat of fusion
Anisotropy	Anisotropic in nature	Isotropic in nature
Nature	True solids	Pseudo solids or super cooled liquids
Order in arrangement of constituent particles	Long range order	Only short range order.

Amorphous solids are useful materials. Glass, rubber and plastics find many applications in our daily lives. Amorphous silicon is one of the best photovoltaic material available for conversion of sunlight into electricity.

Intext Questions

- 1.1 Why are solids rigid?
- 1.2 Why do solids have a definite volume?
- 1.3 Classify the following as amorphous or crystalline solids: Polyurethane, naphthalene, benzoic acid, teflon, potassium nitrate, cellophane, polyvinyl chloride, fibre glass, copper.
- 1.4 Why is glass considered a super cooled liquid?
- 1.5 Refractive index of a solid is observed to have the same value along all directions. Comment on the nature of this solid. Would it show cleavage property?

13 Classification of Crystalline Solids

In Section 1.2, we have learnt about amorphous substances and that they have only short range order. However, most of the solid substances are crystalline in nature. For example, all the metallic elements like iron, copper and silver; non – metallic elements like sulphur, phosphorus and iodine and compounds like sodium chloride, zinc sulphide and naphthalene form crystalline solids.

Crystalline solids can be classified on the basis of nature of intermolecular forces operating in them into four categories viz., molecular, ionic, metallic and covalent solids. Let us now learn about these categories.

1.3.1 Molecular Solids

Molecules are the constituent particles of molecular solids. These are further sub divided into the following categories:

- (i) *Non polar Molecular Solids*: They comprise of either atoms, for example, argon and helium or the molecules formed by non polar covalent bonds for example H_2 , Cl_2 and I_2 . In these solids, the atoms or molecules are held by weak dispersion forces or London forces about which you have learnt in Class XI. These solids are soft and non-conductors of electricity. They have low melting points and are usually in liquid or gaseous state at room temperature and pressure.
- (ii) *Polar Molecular Solids*: The molecules of substances like HCl , SO_2 , etc. are formed by polar covalent bonds. The molecules in such solids are held together by relatively stronger dipole-dipole interactions. These solids are soft and non-conductors of electricity. Their melting points are higher than those of non polar molecular solids yet most of these are gases or liquids under room temperature and pressure. Solid SO_2 and solid NH_3 are some examples of such solids.
- (iii) *Hydrogen Bonded Molecular Solids*: The molecules of such solids contain polar covalent bonds between H and F, O or N atoms. Strong hydrogen bonding binds molecules of such solids like H_2O (ice). They are non-conductors of electricity. Generally they are volatile liquids or soft solids under room temperature and pressure.

1.3.2 Ionic Solids

Ions are the constituent particles of ionic solids. Such solids are formed by the three dimensional arrangements of cations and anions bound by strong coulombic (electrostatic) forces. These solids are hard and brittle in nature. They have high melting and boiling points. Since the ions are not free to move about, they are electrical insulators in the solid state. However, in the molten state or when dissolved in water, the ions become free to move about and they conduct electricity.

1.3.3 Metallic Solids

Metals are orderly collection of positive ions surrounded by and held together by a sea of free electrons. These electrons are mobile and are evenly spread out throughout the crystal. Each metal atom contributes one or more electrons towards this sea of mobile electrons. These free and mobile electrons are responsible for high electrical and thermal conductivity of metals. When an electric field is applied, these electrons flow through the network of positive ions. Similarly, when heat is supplied to one portion of a metal, the thermal energy is uniformly spread throughout by free electrons. Another important characteristic of metals is their lustre and colour in certain cases. This is also due to the presence of free electrons in them. Metals are highly malleable and ductile.

1.3.4 Covalent or Network Solids

A wide variety of crystalline solids of non-metals result from the formation of covalent bonds between adjacent atoms throughout the crystal. They are also called **giant molecules**. Covalent bonds are strong and directional in nature, therefore atoms are held very strongly at their positions. Such solids are very hard and brittle. They have extremely high melting points and may even decompose before melting. They are insulators and do not conduct electricity. Diamond (Fig. 1.3)

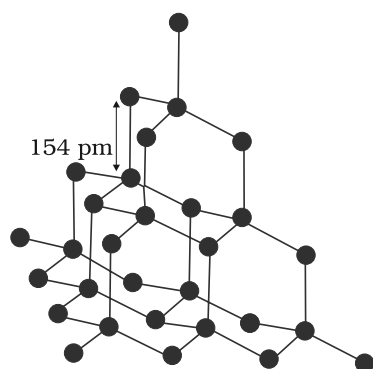

Fig. 1.3: Network structure of diamond

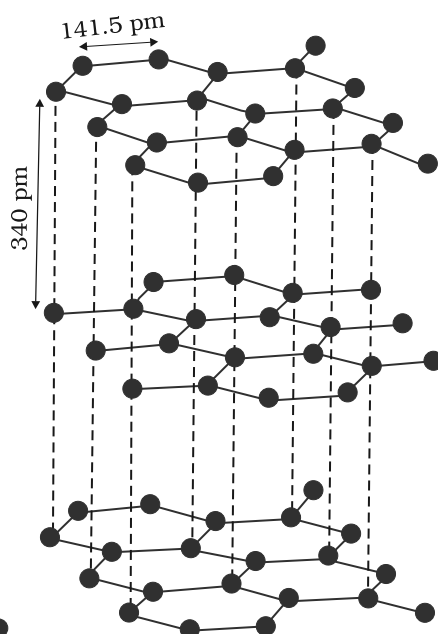

Fig. 1.4: Structure of graphite

and silicon carbide are typical examples of such solids. Graphite is soft and a conductor of electricity. Its exceptional properties are due to its typical structure (Fig. 1.4). Carbon atoms are arranged in different layers and each atom is covalently bonded to three of its neighbouring atoms in the same layer. The fourth valence electron of each atom is present between different layers and is free to move about. These free electrons make graphite a good conductor of electricity. Different layers can slide one over the other. This makes graphite a soft solid and a good solid lubricant.

The different properties of the four types of solids are listed in Table 1.2.

Table 1.2: Different Types of Solids

Type of Solid	Constituent Particles	Bonding/ Attractive Forces	Examples	Physical Nature	Electrical Conductivity	Melting Point
(1) Molecular solids (i) Non polar	Molecules	Dispersion or London forces	Ar, CCl ₄ , H ₂ , I ₂ , CO ₂	Soft	Insulator	Very low
(ii) Polar		Dipole-dipole interactions	HCl, SO ₂	Soft	Insulator	Low
(iii) Hydrogen bonded		Hydrogen bonding	H ₂ O (ice)	Hard	Insulator	Low
(2) Ionic solids	Ions	Coulombic or electrostatic	NaCl, MgO, ZnS, CaF ₂	Hard but brittle	Insulators in solid state but conductors in molten state and in aqueous solutions	High
(3) Metallic solids	Positive ions in a sea of delocalised electrons	Metallic bonding	Fe, Cu, Ag, Mg	Hard but malleable and ductile	Conductors in solid state as well as in molten state	Fairly high
(4) Covalent or network solids	Atoms	Covalent bonding	SiO ₂ (quartz), SiC, C (diamond), AlN,	Hard	Insulators	Very high
			C _(graphite)	Soft	Conductor (exception)	

Intext Questions

- 1.6** Classify the following solids in different categories based on the nature of intermolecular forces operating in them:
Potassium sulphate, tin, benzene, urea, ammonia, water, zinc sulphide, graphite, rubidium, argon, silicon carbide.
- 1.7** Solid A is a very hard electrical insulator in solid as well as in molten state and melts at extremely high temperature. What type of solid is it?
- 1.8** Ionic solids conduct electricity in molten state but not in solid state. Explain.
- 1.9** What type of solids are electrical conductors, malleable and ductile?

14 Crystal Lattices and Unit Cells

The main characteristic of crystalline solids is a regular and repeating pattern of constituent particles. If the three dimensional arrangement of constituent particles in a crystal is represented diagrammatically, in which each particle is depicted as a point, the arrangement is called *crystal lattice*. Thus, a regular three dimensional arrangement of points in space is called a **crystal lattice**. A portion of a crystal lattice is shown in Fig. 1.5.

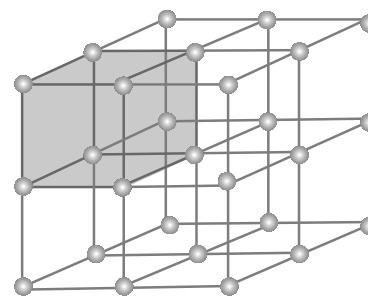

Fig. 1.5: A portion of a three dimensional cubic lattice and its unit cell.

There are only 14 possible three dimensional lattices. These are called **Bravais Lattices** (after the French mathematician who first described them). The following are the characteristics of a crystal lattice:

- Each point in a lattice is called lattice point or lattice site.
- Each point in a crystal lattice represents one constituent particle which may be an atom, a molecule (group of atoms) or an ion.
- Lattice points are joined by straight lines to bring out the geometry of the lattice.

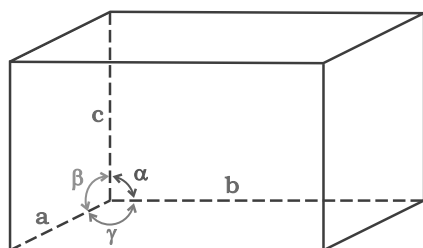

Fig. 1.6: Illustration of parameters of a unit cell

Unit cell is the smallest portion of a crystal lattice which, when repeated in different directions, generates the entire lattice.

A unit cell is characterised by:

- its dimensions along the three edges, a , b and c . These edges may or may not be mutually perpendicular.
- angles between the edges, α (between b and c) β (between a and c) and γ (between a and b). Thus, a unit cell is characterised by six parameters, a , b , c , α , β and γ .

These parameters of a typical unit cell are shown in Fig. 1.6.

1.4.1 Primitive and Centred Unit Cells

Unit cells can be broadly divided into two categories, primitive and centred unit cells.

(a) Primitive Unit Cells

When constituent particles are present only on the corner positions of a unit cell, it is called as **primitive unit cell**.

(b) Centred Unit Cells

When a unit cell contains one or more constituent particles present at positions other than corners in addition to those at corners, it is called a **centred unit cell**. Centred unit cells are of three types:

- Body-Centred Unit Cells:** Such a unit cell contains one constituent particle (atom, molecule or ion) at its body-centre besides the ones that are at its corners.
- Face-Centred Unit Cells:** Such a unit cell contains one constituent particle present at the centre of each face, besides the ones that are at its corners.

(iii) *End-Centred Unit Cells*: In such a unit cell, one constituent particle is present at the centre of any two opposite faces besides the ones present at its corners.

In all, there are seven types of primitive unit cells (Fig. 1.7).

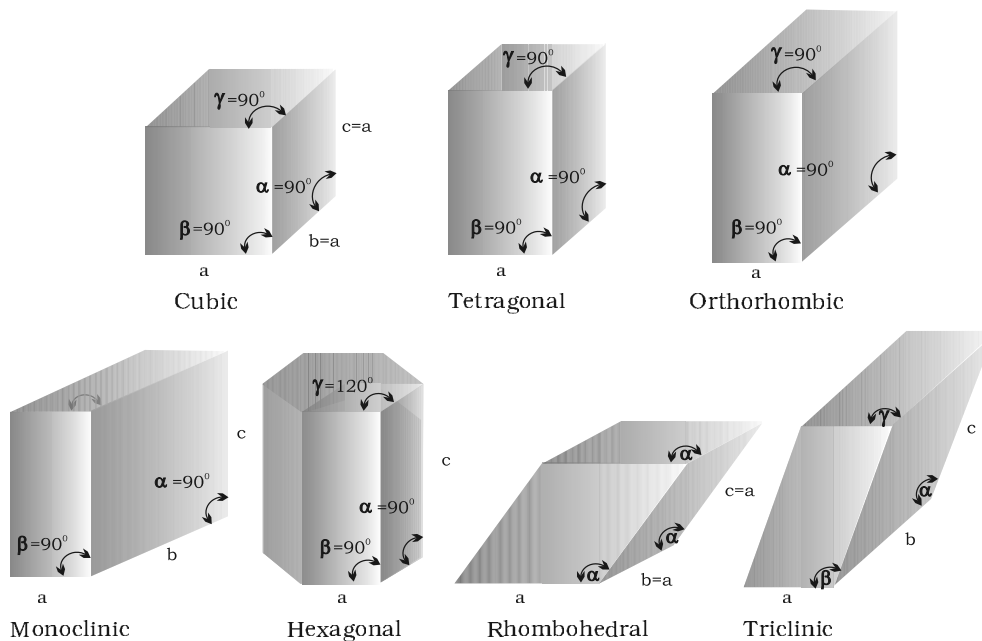

Fig. 1.7: Seven primitive unit cells in crystals

Their characteristics along with the centred unit cells they can form have been listed in Table 1.3.

Table 1.3: Seven Primitive Unit Cells and their Possible Variations as Centred Unit Cells

Crystal system	Possible variations	Axial distances or edge lengths	Axial angles	Examples
Cubic	Primitive, Body-centred, Face-centred	$a = b = c$	$\alpha = \beta = \gamma = 90^\circ$	NaCl, Zinc blende, Cu
Tetragonal	Primitive, Body-centred	$a = b \neq c$	$\alpha = \beta = \gamma = 90^\circ$	White tin, SnO_2 , TiO_2 , CaSO_4
Orthorhombic	Primitive, Body-centred, Face-centred, End-centred	$a \neq b \neq c$	$\alpha = \beta = \gamma = 90^\circ$	Rhombic sulphur, KNO_3 , BaSO_4
Hexagonal	Primitive	$a = b \neq c$	$\alpha = \beta = 90^\circ$ $\gamma = 120^\circ$	Graphite, ZnO, CdS,
Rhombohedral or Trigonal	Primitive	$a = b = c$	$\alpha = \beta = \gamma \neq 90^\circ$	Calcite (CaCO_3), HgS (cinnabar)

Unit Cells of 14 Types of Bravais Lattices

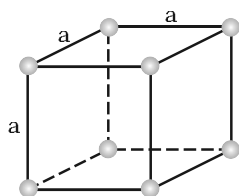

Primitive
(or simple)

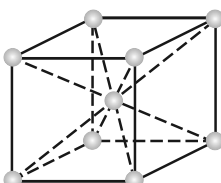

Body-centred

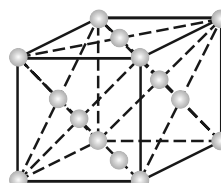

Face-centred

The three cubic lattices: all sides of same length, angles between faces all 90°

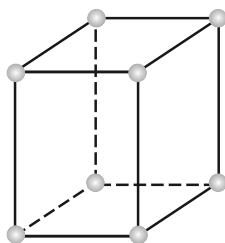

Primitive

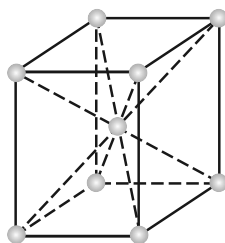

Body-centred

The two tetragonal: one side different in length to the other, two angles between faces all 90°

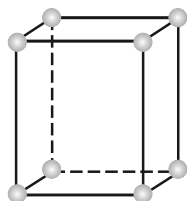

Primitive

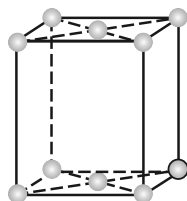

End-centred

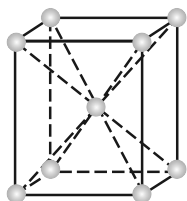

Body-centred

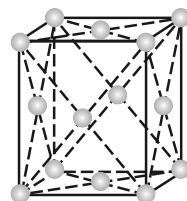

Face-centred

The four orthorhombic lattices: unequal sides, angles between faces all 90°

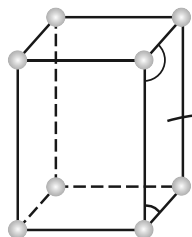

Primitive

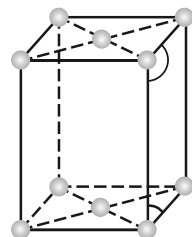
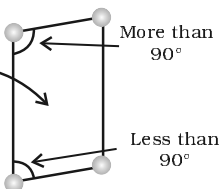

End-centred

The two monoclinic lattices: unequal sides, two faces have angles different to 90°

108 H0 00 H2 ,0

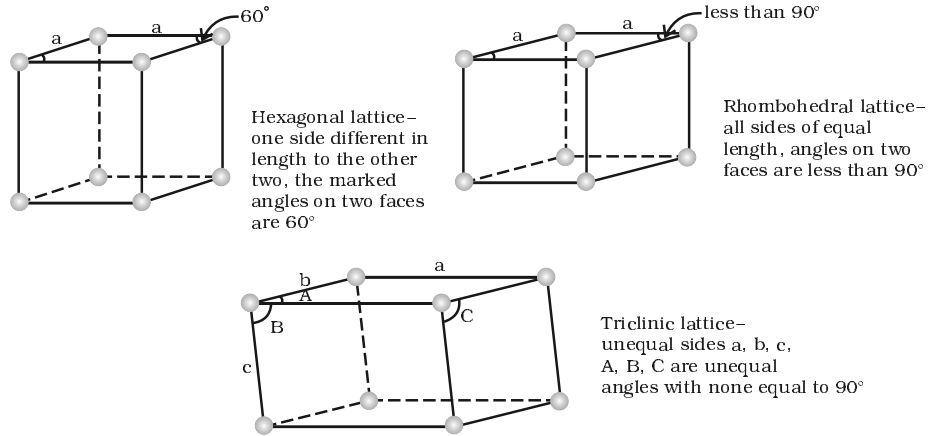

15 Number of Atoms in a Unit Cell

1.5.1 Primitive Cubic Unit Cell

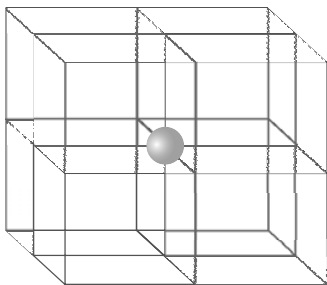

Fig. 1.8: In a simple cubic unit cell, each corner atom is shared between 8 unit cells.

or ion) actually belongs to a particular unit cell. In Fig. 1.9, a primitive cubic unit cell has been depicted in three different ways. Each small sphere in Fig. 1.9 (a) represents only the centre of the particle occupying that position and not its actual size. Such structures are called *open structures*. The arrangement of particles is easier to follow in open structures. Fig. 1.9 (b) depicts space-filling representation of the unit cell with actual particle size and Fig. 1.9 (c) shows the actual portions of different atoms present in a cubic unit cell.

In all, since each cubic unit cell has 8 atoms on its corners, the total number of atoms in one unit cell is $8 \times \frac{1}{8} = 1$ atom.

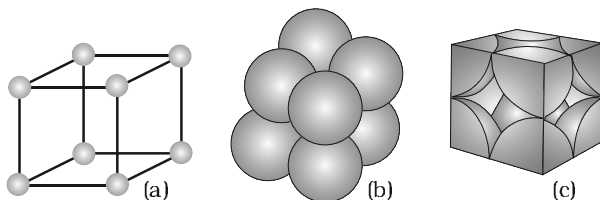

Fig. 1.9: A primitive cubic unit cell (a) open structure (b) space-filling structure (c) actual portions of atoms belonging to one unit cell.

1.5.2 Body-Centred Cubic Unit Cell

A body-centred cubic (*bcc*) unit cell has an atom at each of its corners and also one atom at its body centre. Fig. 1.10 depicts (a) open structure (b) space filling model and (c) the unit cell with portions of atoms actually belonging to it. It can be seen that the atom at the

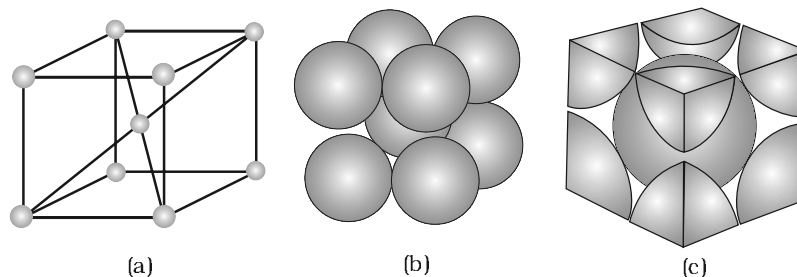

Fig. 1.10: A body-centred cubic unit cell (a) open structure (b) space-filling structure (c) actual portions of atoms belonging to one unit cell.

body centre wholly belongs to the unit cell in which it is present. Thus in a body-centred cubic (*bcc*) unit cell:

$$\begin{aligned} \text{(i) } 8 \text{ corners} \times \frac{1}{8} \text{ per corner atom} &= 8 \times \frac{1}{8} &&= 1 \text{ atom} \\ \text{(ii) } 1 \text{ body centre atom} &= 1 \times 1 &&= 1 \text{ atom} \\ \therefore \text{Total number of atoms per unit cell} &&&= 2 \text{ atoms} \end{aligned}$$

1.5.3 Face-Centred Cubic Unit Cell

A face-centred cubic (*fcc*) unit cell contains atoms at all the corners and at the centre of all the faces of the cube. It can be seen in Fig. 1.11 that each atom located at the face-centre is shared between two adjacent unit cells and only $\frac{1}{2}$ of each atom belongs to a unit cell. Fig. 1.12 depicts (a) open structure (b) space-filling model and (c) the unit cell with portions of atoms actually belonging to it. Thus, in a face-centred cubic (*fcc*) unit cell:

$$\begin{aligned} \text{(i) } 8 \text{ corners atoms} \times \frac{1}{8} \text{ atom per unit cell} &= 8 \times \frac{1}{8} &&= 1 \text{ atom} \\ \text{(ii) } 6 \text{ face-centred atoms} \times \frac{1}{2} \text{ atom per unit cell} &= 6 \times \frac{1}{2} &&= 3 \text{ atoms} \\ \therefore \text{Total number of atoms per unit cell} &&&= 4 \text{ atoms} \end{aligned}$$

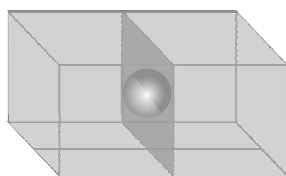

Fig. 1.11: An atom at face centre of unit cell is shared between 2 unit cells

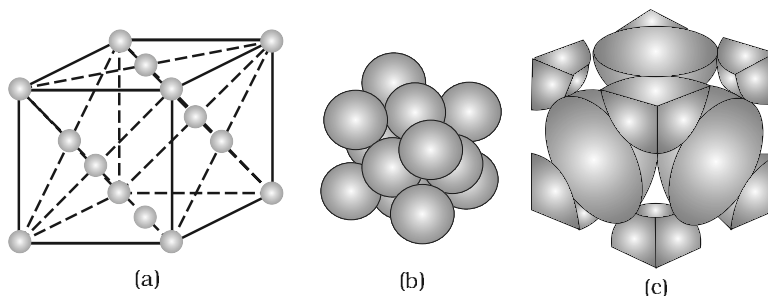

Fig 1.12: A face-centred cubic unit cell (a) open structure (b) space filling structure (c) actual portions of atoms belonging to one unit cell.

Intext Questions

- 1.10** Give the significance of a 'lattice point'.
1.11 Name the parameters that characterise a unit cell.
1.12 Distinguish between
(i) Hexagonal and monoclinic unit cells
(ii) Face-centred and end-centred unit cells.
1.13 Explain how much portion of an atom located at (i) corner and (ii) body-centre of a cubic unit cell is part of its neighbouring unit cell.

1.6 Close Packed Structures

In solids, the constituent particles are close-packed, leaving the minimum vacant space. Let us consider the constituent particles as identical hard spheres and build up the three dimensional structure in three steps.

(a) Close Packing in One Dimension

There is only one way of arranging spheres in a one dimensional close packed structure, that is to arrange them in a row and touching each other (Fig. 1.13).



Fig. 1.13: Close packing of spheres in one dimension

In this arrangement, each sphere is in contact with two of its neighbours. The number of nearest neighbours of a particle is called its **coordination number**. Thus, in one dimensional close packed arrangement, the coordination number is 2.

(b) Close Packing in Two Dimensions

Two dimensional close packed structure can be generated by stacking (placing) the rows of close packed spheres. This can be done in two different ways.

- (i) The second row may be placed in contact with the first one such that the spheres of the second row are exactly above those of the first row. The spheres of the two rows are aligned horizontally as well as vertically. If we call the first row as 'A' type row, the second row being exactly the same as the first one, is also of 'A' type. Similarly, we may place more rows to obtain AAA type of arrangement as shown in Fig. 1.14 (a).

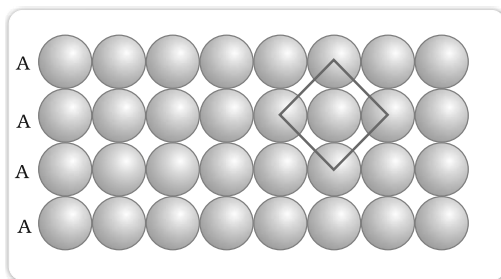

(a)

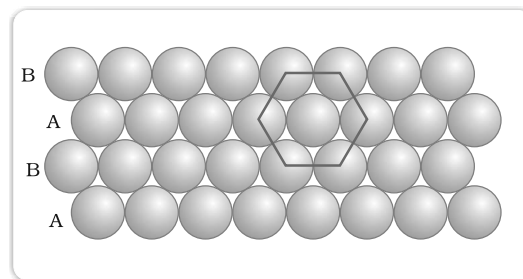

(b)

Fig. 1.14: (a) Square close packing (b) hexagonal close packing of spheres in two dimensions

In this arrangement, each sphere is in contact with four of its neighbours. Thus, the two dimensional coordination number is 4. Also, if the centres of these 4 immediate neighbouring spheres are joined, a square is formed. Hence this packing is called **square close packing in two dimensions**.

- (ii) The second row may be placed above the first one in a staggered manner such that its spheres fit in the depressions of the first row. If the arrangement of spheres in the first row is called 'A' type, the one in the second row is different and may be called 'B' type. When the third row is placed adjacent to the second in staggered manner, its spheres are aligned with those of the first layer. Hence this layer is also of 'A' type. The spheres of similarly placed fourth row will be aligned with those of the second row ('B' type). Hence this arrangement is of ABAB type. In this arrangement there is less free space and this packing is more efficient than the square close packing. Each sphere is in contact with six of its neighbours and the two dimensional coordination number is 6. The centres of these six spheres are at the corners of a regular hexagon (Fig. 1.14b) hence this packing is called **two dimensional hexagonal close-packing**. It can be seen in Figure 1.14 (b) that in this layer there are some voids (empty spaces). These are triangular in shape. The triangular voids are of two different types. In one row, the apex of the triangles are pointing upwards and in the next layer downwards.

(c) Close Packing in Three Dimensions

All real structures are three dimensional structures. They can be obtained by stacking two dimensional layers one above the other. In the last Section, we discussed close packing in two dimensions which can be of two types; square close-packed and hexagonal close-packed. Let us see what types of three dimensional close packing can be obtained from these.

- (i) *Three dimensional close packing from two dimensional square close-packed layers:* While placing the second square close-packed layer above the first we follow the same rule that was followed when one row was placed adjacent to the other.

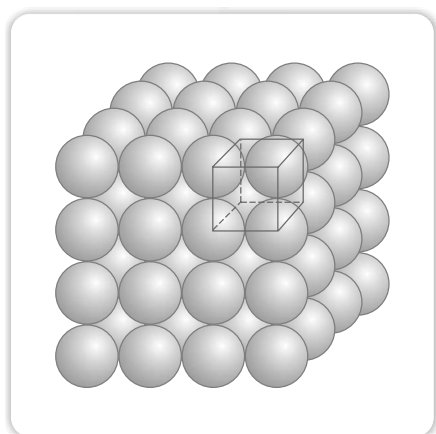

Fig. 1.15: Simple cubic lattice formed by A A A arrangement

The second layer is placed over the first layer such that the spheres of the upper layer are exactly above those of the first layer. In this arrangement spheres of both the layers are perfectly aligned horizontally as well as vertically as shown in Fig. 1.15. Similarly, we may place more layers one above the other. If the arrangement of spheres in the first layer is called 'A' type, all the layers have the same arrangement. Thus this lattice has AAA.... type pattern. The lattice thus generated is the simple cubic lattice, and its unit cell is the primitive cubic unit cell (See Fig. 1.9).

- (ii) *Three dimensional close packing from two dimensional hexagonal close packed layers:* Three dimensional close packed structure can be generated by placing layers one over the other.

(a) Placing second layer over the first layer

Let us take a two dimensional hexagonal close packed layer 'A' and place a similar layer above it such that the spheres of the second layer are placed in the depressions of the first layer. Since the spheres of the two layers are aligned differently, let us call the second layer as B. It can be observed from Fig. 1.16 that not all the triangular voids of the first layer are covered by the spheres of the second layer. This gives rise to different arrangements. Wherever a sphere of the second layer is above the void of the first layer (or vice versa) a tetrahedral void is

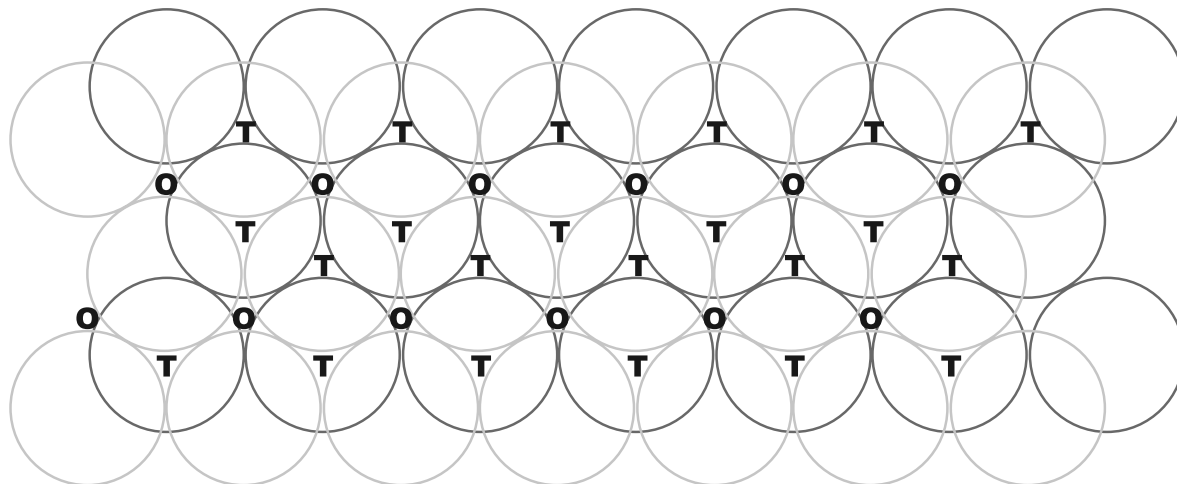
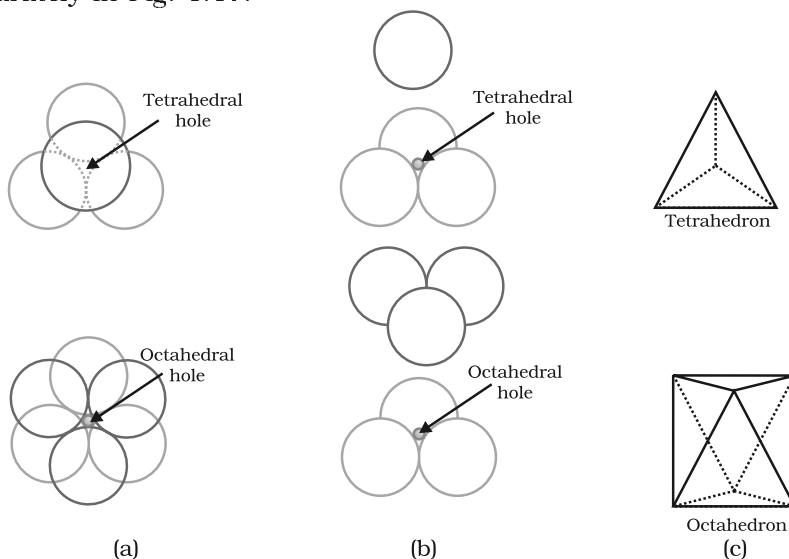

Fig. 1.16: A stack of two layers of close packed spheres and voids generated in them. T = Tetrahedral void; O = Octahedral void

formed. These voids are called **tetrahedral voids** because a *tetrahedron* is formed when the centres of these four spheres are joined. They have been marked as 'T' in Fig. 1.16. One such void has been shown separately in Fig. 1.17.

Fig 1.17
Tetrahedral and octahedral voids
(a) top view
(b) exploded side view and
(c) geometrical shape of the void.



At other places, the triangular voids in the second layer are above the triangular voids in the first layer, and the triangular shapes of these do not overlap. One of them has the apex of the triangle pointing upwards and the other downwards. These voids have been marked as 'O' in Fig. 1.16. Such voids are surrounded by six spheres and are called **octahedral voids**. One such void has been shown separately in Fig. 1.17. The number of these two types of voids depend upon the number of close packed spheres.

Let the number of close packed spheres be N , then:

The number of octahedral voids generated = N

The number of tetrahedral voids generated = $2N$

(b) Placing third layer over the second layer

When third layer is placed over the second, there are two possibilities.

- (i) **Covering Tetrahedral Voids:** Tetrahedral voids of the second layer may be covered by the spheres of the third layer. In this case, the spheres of the third layer are exactly aligned with those of the first layer. Thus, the pattern of spheres is repeated in alternate layers. This pattern is often written as ABAB pattern. This structure is called hexagonal close packed (*hcp*) structure (Fig. 1.18). This sort of arrangement of atoms is found in many metals like magnesium and zinc.

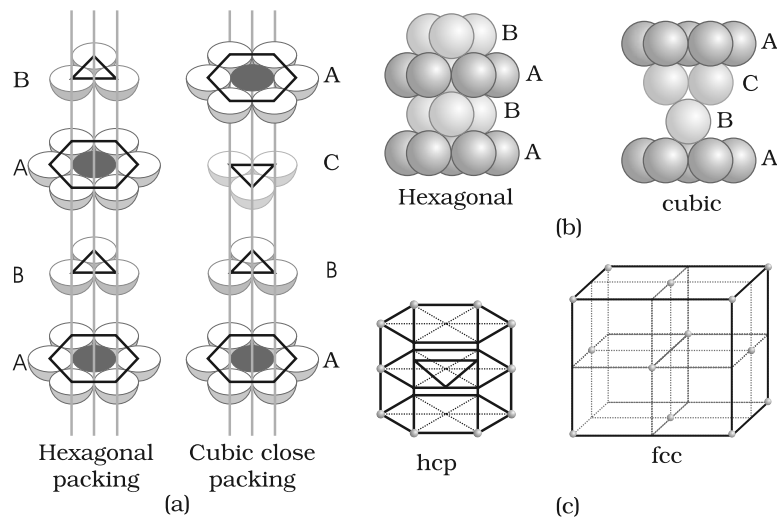
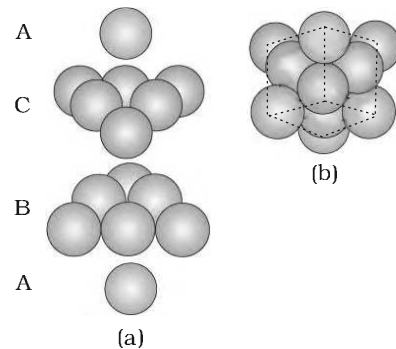

Fig. 1.18
(a) Hexagonal cubic close-packing exploded view showing stacking of layers of spheres
(b) four layers stacked in each case
and (c) geometry of packing.

Fig. 1.19
(a) ABCABC... arrangement of layers when octahedral void is covered (b) fragment of structure formed by this arrangement resulting in cubic closed packed (ccp) or face centred cubic (fcc) structure.



- (ii) **Covering Octahedral Voids:** The third layer may be placed above the second layer in a manner such that its spheres cover the octahedral voids. When placed in this manner, the spheres of the third layer are not aligned with those of either the first or the second layer. This arrangement is called "C" type. Only when fourth layer is placed, its spheres are aligned with

those of the first layer as shown in Figs. 1.18 and 1.19. This pattern of layers is often written as ABCABC This structure is called cubic close packed (*ccp*) or face-centred cubic (*fcc*) structure. Metals such as copper and silver crystallise in this structure.

Both these types of close packing are highly efficient and 74% space in the crystal is filled. In either of them, each sphere is in contact with twelve spheres. Thus, the coordination number is 12 in either of these two structures.

1.6.1 Formula of a Compound and Number of Voids Filled

Earlier in the section, we have learnt that when particles are close-packed resulting in either *ccp* or *hcp* structure, two types of voids are generated. While the number of octahedral voids present in a lattice is equal to the number of close packed particles, the number of tetrahedral voids generated is twice this number. In ionic solids, the bigger ions (usually anions) form the close packed structure and the smaller ions (usually cations) occupy the voids. If the latter ion is small enough then tetrahedral voids are occupied, if bigger, then octahedral voids. Not all octahedral or tetrahedral voids are occupied. In a given compound, the fraction of octahedral or tetrahedral voids that are occupied, depends upon the chemical formula of the compound, as can be seen from the following examples.

Example 1.1

A compound is formed by two elements X and Y. Atoms of the element Y (as anions) make *ccp* and those of the element X (as cations) occupy all the octahedral voids. What is the formula of the compound?

Solution

The *ccp* lattice is formed by the element Y. The number of octahedral voids generated would be equal to the number of atoms of Y present in it. Since all the octahedral voids are occupied by the atoms of X, their number would also be equal to that of the element Y. Thus, the atoms of elements X and Y are present in equal numbers or 1:1 ratio. Therefore, the formula of the compound is XY.

Example 1.2

Atoms of element B form *hcp* lattice and those of the element A occupy 2/3rd of tetrahedral voids. What is the formula of the compound formed by the elements A and B?

Solution

The number of tetrahedral voids formed is equal to twice the number of atoms of element B and only 2/3rd of these are occupied by the atoms of element A. Hence the ratio of the number of atoms of A and B is $2 \times (2/3):1$ or 4:3 and the formula of the compound is A_4B_3 .

Locating Tetrahedral and Octahedral Voids

We know that close packed structures have both tetrahedral and octahedral voids. Let us take *ccp* (or *fcc*) structure and locate these voids in it.

(a) Locating Tetrahedral Voids

Let us consider a unit cell of *ccp* or *fcc* lattice [Fig. 1(a)]. The unit cell is divided into eight small cubes.

Each small cube has atoms at alternate corners [Fig. 1(a)]. In all, each small cube has 4 atoms. When joined to each other, they make a regular tetrahedron. Thus, there is one tetrahedral void in each small cube and eight tetrahedral voids in total. Each of the eight small cubes have one void in one unit cell of *ccp* structure. We know that *ccp* structure has 4 atoms per unit cell. Thus, the number of tetrahedral voids is twice the number of atoms.

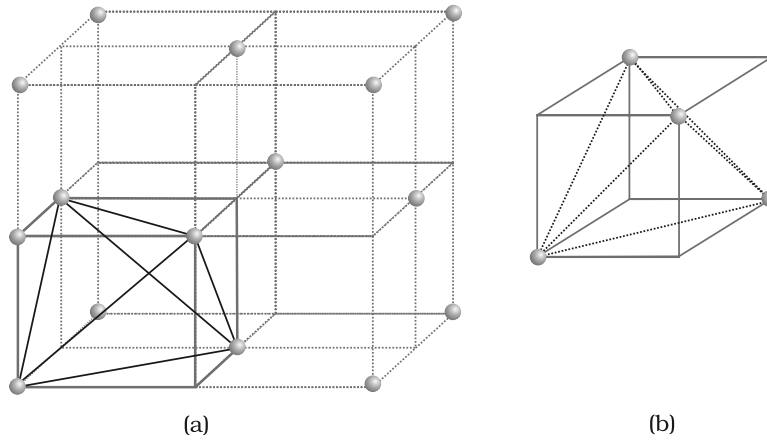

Fig. 1: (a) Eight tetrahedral voids per unit cell of *ccp* structure
(b) one tetrahedral void showing the geometry.

(b) Locating Octahedral Voids

Let us again consider a unit cell of *ccp* or *fcc* lattice [Fig. 2(a)]. The body centre of the cube, C is not occupied but it is surrounded by six atoms on face centres. If these face centres are joined, an octahedron is generated. Thus, this unit cell has one octahedral void at the body centre of the cube.

Besides the body centre, there is one octahedral void at the centre of each of the 12 edges. [Fig. 2(b)]. It is surrounded by six atoms, three belonging to the same unit cell (2 on the corners and 1 on face centre) and three belonging to two adjacent unit cells. Since each edge of the cube is shared between four adjacent unit cells, so is the octahedral void located on it. Only $\frac{1}{4}^{\text{th}}$ of each void belongs to a particular unit cell.

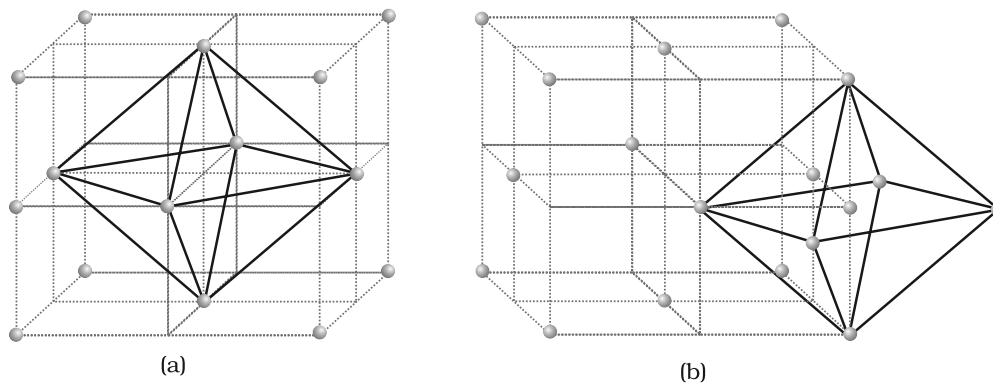

Fig. 2: Location of octahedral voids per unit cell of *ccp* or *fcc* lattice (a) at the body centre of the cube and (b) at the centre of each edge (only one such void is shown).

Thus in *cubic close packed structure*:

Octahedral void at the body-centre of the cube = 1

12 octahedral voids located at each edge and shared between four unit cells

$$= 12 \times \frac{1}{4} = 3$$

\therefore Total number of octahedral voids = 4

We know that in ccp structure, each unit cell has 4 atoms. Thus, the number of octahedral voids is equal to this number.

17 Packing Efficiency

In whatever way the constituent particles (atoms, molecules or ions) are packed, there is always some free space in the form of voids. **Packing efficiency** is the percentage of total space filled by the particles. Let us calculate the packing efficiency in different types of structures.

1.7.1 Packing Efficiency in hcp and ccp Structures

Both types of close packing (*hcp* and *ccp*) are equally efficient. Let us calculate the efficiency of packing in ccp structure. In Fig. 1.20 let the unit cell edge length be 'a' and face diagonal AC = b.

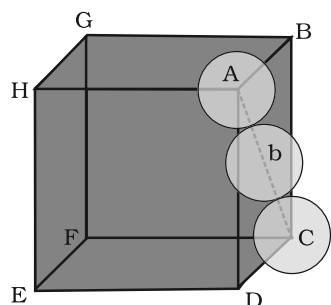

Fig. 1.20: Cubic close packing other sides are not provided with spheres for sake of clarity.

In ΔABC

$$AC^2 = b^2 = BC^2 + AB^2$$

$$= a^2 + a^2 = 2a^2 \text{ or}$$

$$b = \sqrt{2}a$$

If r is the radius of the sphere, we find

$$b = 4r = \sqrt{2}a$$

$$\text{or } a = \frac{4r}{\sqrt{2}} = 2\sqrt{2}r$$

(we can also write, $r = \frac{a}{2\sqrt{2}}$)

We know, that each unit cell in ccp structure, has effectively 4 spheres. Total volume of four spheres is equal to $4 \times (4/3)\pi r^3$ and volume of the cube is a^3 or $(2\sqrt{2}r)^3$.

Therefore,

$$\text{Packing efficiency} = \frac{\text{Volume occupied by four spheres in the unit cell} \times 100}{\text{Total volume of the unit cell}} \%$$

$$= \frac{4 \times (4/3)\pi r^3 \times 100}{(2\sqrt{2}r)^3} \%$$

$$= \frac{(16/3)\pi r^3 \times 100}{16\sqrt{2}r^3} \% = 74\%$$

1.7.2 Efficiency of Packing in Body-Centred Cubic Structures

From Fig. 1.21, it is clear that the atom at the centre will be in touch with the other two atoms diagonally arranged.

$$\begin{aligned} \text{In } \Delta EFD, \\ b^2 &= a^2 + a^2 = 2a^2 \\ b &= \sqrt{2}a \end{aligned}$$

$$\begin{aligned} \text{Now in } \Delta AFD \\ c^2 &= a^2 + b^2 = a^2 + 2a^2 = 3a^2 \\ c &= \sqrt{3}a \end{aligned}$$

The length of the body diagonal c is equal to $4r$, where r is the radius of the sphere (atom), as all the three spheres along the diagonal touch each other.

$$\begin{aligned} \text{Therefore, } \sqrt{3}a &= 4r \\ a &= \frac{4r}{\sqrt{3}} \end{aligned}$$

$$\text{Also we can write, } r = \frac{\sqrt{3}}{4} a$$

In this type of structure, total number of atoms is 2 and their volume is $2 \times \left(\frac{4}{3}\right)\pi r^3$.

$$\text{Volume of the cube, } a^3 \text{ will be equal to } \left(\frac{4}{\sqrt{3}}r\right)^3 \text{ or } a^3 = \left(\frac{4}{\sqrt{3}}r\right)^3.$$

Therefore,

$$\begin{aligned} \text{Packing efficiency} &= \frac{\text{Volume occupied by two spheres in the unit cell} \times 100}{\text{Total volume of the unit cell}} \% \\ &= \frac{2 \times \left(\frac{4}{3}\right)\pi r^3 \times 100}{\left[\left(\frac{4}{\sqrt{3}}r\right)^3\right]} \% \\ &= \frac{(8/3)\pi r^3 \times 100}{64 / (3\sqrt{3})r^3} \% = 68\% \end{aligned}$$

1.7.3 Packing Efficiency in Simple Cubic Lattice

In a simple cubic lattice the atoms are located only on the corners of the cube. The particles touch each other along the edge (Fig. 1.22). Thus, the edge length or side of the cube 'a', and the radius of each particle, r are related as

$$a = 2r$$

$$\text{The volume of the cubic unit cell} = a^3 = (2r)^3 = 8r^3$$

Since a simple cubic unit cell contains only 1 atom

$$\text{The volume of the occupied space} = \frac{4}{3}\pi r^3$$

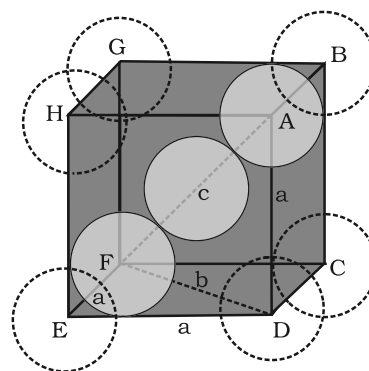
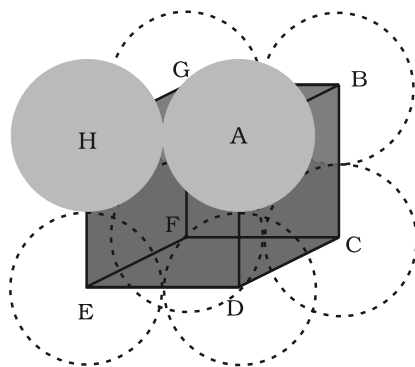

Fig. 1.21: Body-centred cubic unit cell (sphere along the body diagonal are shown with solid boundaries).

Fig. 1.22
Simple cubic unit cell.
The spheres are in contact with each other along the edge of the cube.



∴ Packing efficiency

$$\begin{aligned}
 &= \frac{\text{Volume of one atom}}{\text{Volume of cubic unit cell}} \times 100\% \\
 &= \frac{\frac{4}{3}\pi r^3}{8r^3} \times 100 = \frac{\pi}{6} \times 100 \\
 &= 52.36\% = 52.4\%
 \end{aligned}$$

Thus, we may conclude that *ccp* and *hcp* structures have maximum packing efficiency.

1.8 Calculations Involving Unit Cell Dimensions

From the unit cell dimensions, it is possible to calculate the volume of the unit cell. Knowing the density of the metal, we can calculate the mass of the atoms in the unit cell. The determination of the mass of a single atom gives an accurate method of determination of Avogadro constant. Suppose, edge length of a unit cell of a cubic crystal determined by X-ray diffraction is a , d the density of the solid substance and M the molar mass. In case of cubic crystal:

$$\text{Volume of a unit cell} = a^3$$

Mass of the unit cell

$$= \text{number of atoms in unit cell} \times \text{mass of each atom} = z \times m$$

(Here z is the number of atoms present in one unit cell and m is the mass of a single atom)

Mass of an atom present in the unit cell:

$$m = \frac{M}{N_A} \quad (M \text{ is molar mass})$$

Therefore, density of the unit cell

$$\begin{aligned}
 &= \frac{\text{mass of unit cell}}{\text{volume of unit cell}} \\
 &= \frac{z \cdot m}{a^3} = \frac{z \cdot M}{a^3 \cdot N_A} \quad \text{or} \quad d = \frac{zM}{a^3 N_A}
 \end{aligned}$$

Remember, the density of the unit cell is the same as the density of the substance. The density of the solid can always be determined by other methods. Out of the five parameters (d , z , M , a and N_A), if any four are known, we can determine the fifth.

Example 1.3 An element has a body-centred cubic (*bcc*) structure with a cell edge of 288 pm. The density of the element is 7.2 g/cm³. How many atoms are present in 208 g of the element?

Solution

$$\begin{aligned}
 \text{Volume of the unit cell} &= (288 \text{ pm})^3 \\
 &= (288 \times 10^{-12} \text{ m})^3 = (288 \times 10^{-10} \text{ cm})^3 \\
 &= 2.39 \times 10^{-23} \text{ cm}^3
 \end{aligned}$$

Volume of 208 g of the element

$$= \frac{\text{mass}}{\text{density}} = \frac{208\text{g}}{7.2\text{g cm}^{-3}} = 28.88\text{cm}^3$$

Number of unit cells in this volume

$$= \frac{28.88\text{cm}^3}{2.39 \times 10^{-23}\text{cm}^3 / \text{unit cell}} = 12.08 \times 10^{23} \text{ unit cells}$$

Since each *bcc* cubic unit cell contains 2 atoms, therefore, the total number of atoms in 208 g = 2 (atoms/unit cell) \times 12.08×10^{23} unit cells

$$= 24.16 \times 10^{23} \text{ atoms}$$

X-ray diffraction studies show that copper crystallises in an *fcc* unit cell with cell edge of 3.608×10^{-8} cm. In a separate experiment, copper is determined to have a density of 8.92 g/cm^3 , calculate the atomic mass of copper.

Example 1.4

In case of *fcc* lattice, number of atoms per unit cell, $z = 4$ atoms

Solution

$$\text{Therefore, } M = \frac{d N_A a^3}{z}$$

$$= \frac{8.92\text{g cm}^3 \times 6.022 \times 10^{23} \text{ atoms mol}^{-1} \times (3.608 \times 10^{-8} \text{ cm})^3}{4 \text{ atoms}}$$

$$= 63.1 \text{ g/mol}$$

Atomic mass of copper = 63.1 u

Silver forms *ccp* lattice and X-ray studies of its crystals show that the edge length of its unit cell is 408.6 pm. Calculate the density of silver (Atomic mass = 107.9 u).

Example 1.5

Since the lattice is *ccp*, the number of silver atoms per unit cell = $z = 4$

Solution

$$\text{Molar mass of silver} = 107.9 \text{ g mol}^{-1} = 107.9 \times 10^{-3} \text{ kg mol}^{-1}$$

$$\text{Edge length of unit cell} = a = 408.6 \text{ pm} = 408.6 \times 10^{-12} \text{ m}$$

$$\text{Density, } d = \frac{z.M}{a^3 . N_A}$$

$$= \frac{4 \times (107.9 \times 10^{-3} \text{ kg mol}^{-1})}{(408.6 \times 10^{-12} \text{ m})^3 (6.022 \times 10^{23} \text{ mol}^{-1})} = 10.5 \times 10^3 \text{ kg m}^{-3}$$
$$= 10.5 \text{ g cm}^{-3}$$

Intext Questions

- 1.14 What is the two dimensional coordination number of a molecule in *square close-packed* layer?
- 1.15 A compound forms *hexagonal close-packed* structure. What is the total number of voids in 0.5 mol of it? How many of these are tetrahedral voids?

- 1.16 A compound is formed by two elements M and N. The element N forms *ccp* and atoms of M occupy 1/3rd of tetrahedral voids. What is the formula of the compound?
- 1.17 Which of the following lattices has the highest packing efficiency (i) simple cubic (ii) body-centred cubic and (iii) hexagonal close-packed lattice?
- 1.18 An element with molar mass $2.7 \times 10^{-2} \text{ kg mol}^{-1}$ forms a cubic unit cell with edge length 405 pm. If its density is $2.7 \times 10^3 \text{ kg}^{-3}$, what is the nature of the cubic unit cell?

1.9 Imperfections in Solids

Although crystalline solids have short range as well as long range order in the arrangement of their constituent particles, yet crystals are not perfect. Usually a solid consists of an aggregate of large number of small crystals. These small crystals have defects in them. This happens when crystallisation process occurs at fast or moderate rate. Single crystals are formed when the process of crystallisation occurs at extremely slow rate. Even these crystals are not free of defects. The defects are basically irregularities in the arrangement of constituent particles. Broadly speaking, the defects are of two types, namely, *point defects* and *line defects*. **Point defects** are the irregularities or deviations from ideal arrangement around a point or an atom in a crystalline substance, whereas the *line defects* are the irregularities or deviations from ideal arrangement in entire rows of lattice points. These irregularities are called *crystal defects*. We shall confine our discussion to point defects only.

1.9.1 Types of Point Defects

Point defects can be classified into three types : (i) stoichiometric defects (ii) impurity defects and (iii) non-stoichiometric defects.

(a) Stoichiometric Defects

These are the point defects that do not disturb the stoichiometry of the solid. They are also called *intrinsic* or **thermodynamic defects**. Basically these are of two types, vacancy defects and interstitial defects.

(i) *Vacancy Defect*: When some of the lattice sites are vacant, the crystal is said to have **vacancy defect** (Fig. 1.23). This results in decrease in density of the substance. This defect can also develop when a substance is heated.

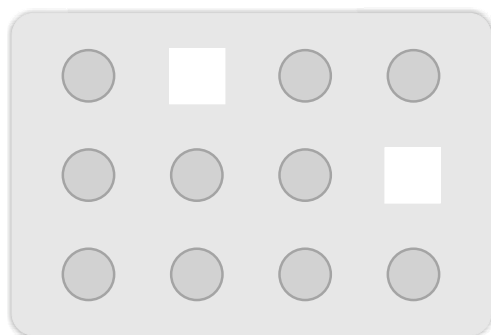

Fig. 1.23: Vacancy defects

(ii) *Interstitial Defect*: When some constituent particles (atoms or molecules) occupy an **interstitial** site, the crystal is said to have **interstitial defect** (Fig. 1.24). This defect increases the density of the substance.

Vacancy and interstitial defects as explained above can be shown by non-ionic solids. Ionic solids must always maintain electrical neutrality. Rather than simple vacancy or interstitial defects, they show these defects as **Frenkel and Schottky defects**.

(iii) **Frenkel Defect:** This defect is shown by ionic solids. The smaller ion (usually cation) is dislocated from its normal site to an interstitial site (Fig. 1.25). It creates a *vacancy defect* at its original site and an **interstitial defect** at its new location.

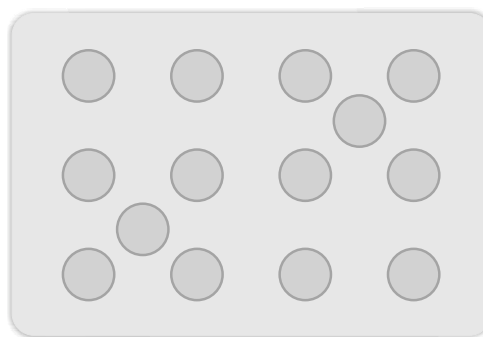

Fig. 1.24: Interstitial defects

Frenkel defect is also called **dislocation defect**.

It does not change the density of the solid. Frenkel defect is shown by ionic substance in which there is a large difference in the size of ions, for example, ZnS, AgCl, AgBr and AgI due to small size of Zn^{2+} and Ag^+ ions.

(iv) **Schottky Defect:** It is basically a vacancy defect in ionic solids. In order to maintain electrical neutrality, the number of missing cations and anions are equal (Fig. 1.26).

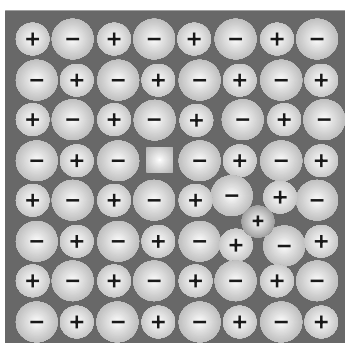

Fig. 1.25: Frenkel defects

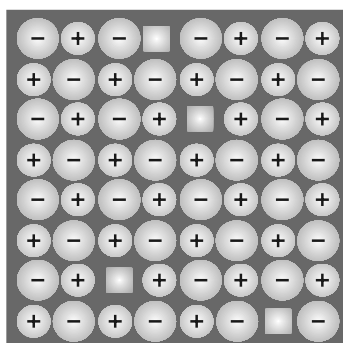

Fig. 1.26: Schottky defects

Like simple vacancy defect, Schottky defect also decreases the density of the substance. Number of such defects in ionic solids is quite significant. For example, in NaCl there are approximately 10^6 Schottky pairs per cm^3 at room temperature. In 1 cm^3 there are about 10^{22} ions. Thus, there is one Schottky defect per 10^{16} ions. Schottky defect is shown by ionic substances in which the

cation and anion are of almost similar sizes. For example, NaCl, KCl, CsCl and AgBr. It may be noted that AgBr shows both, Frenkel as well as Schottky defects.

(b) Impurity Defects

If molten NaCl containing a little amount of SrCl_2 is crystallised, some of the sites of Na^+ ions are occupied by Sr^{2+} (Fig. 1.27). Each Sr^{2+} replaces two Na^+ ions. It occupies the site of one ion and the other site remains vacant. The cationic vacancies thus produced are equal in number to that of Sr^{2+} ions. Another similar example is the solid solution of CdCl_2 and AgCl.

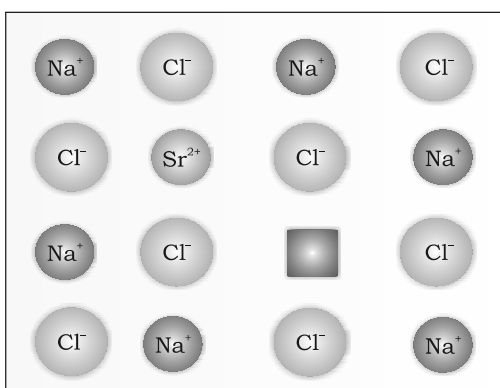

Fig. 1.27: Introduction of cation vacancy in NaCl by substitution of Na^+ by Sr^{2+}

(c) Non-Stoichiometric Defects

The defects discussed so far do not disturb the stoichiometry of the crystalline substance. However, a large number of non-stoichiometric inorganic solids are known which contain the constituent elements in non-stoichiometric ratio due to defects in their crystal structures. These defects are of two types: (i) metal excess defect and (ii) metal deficiency defect.

(i) Metal Excess Defect

- *Metal excess defect due to anionic vacancies:* Alkali halides like NaCl and KCl show this type of defect. When crystals of NaCl are heated in an atmosphere of sodium vapour, the sodium atoms are deposited on the surface of the crystal. The Cl^- ions diffuse to the surface of the crystal and combine with Na atoms to give NaCl. This happens by loss of electron by sodium atoms to form Na^+ ions. The released electrons diffuse into the crystal and occupy anionic sites (Fig. 1.28). As a result the crystal now has an excess of sodium. The anionic sites occupied by unpaired electrons are called *F-centres* (from the German word *Farbenzenter* for colour centre). They impart yellow colour to the crystals of NaCl. The colour results by excitation of these electrons when they absorb energy from the visible light falling on the crystals. Similarly, excess of lithium makes LiCl crystals pink and excess of potassium makes KCl crystals violet (or lilac).

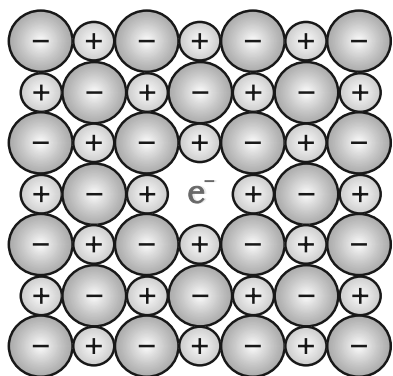
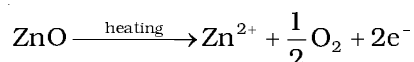

Fig. 1.28: An F-centre in a crystal

- *Metal excess defect due to the presence of extra cations at interstitial sites:* Zinc oxide is white in colour at room temperature. On heating it loses oxygen and turns yellow.



Now there is excess of zinc in the crystal and its formula becomes Zn_{1+x}O . The excess Zn^{2+} ions move to interstitial sites and the electrons to neighbouring interstitial sites.

(ii) Metal Deficiency Defect

There are many solids which are difficult to prepare in the stoichiometric composition and contain less amount of the metal as compared to the stoichiometric proportion. A typical example of this type is FeO which is mostly found with a composition of $\text{Fe}_{0.95}\text{O}$. It may actually range from $\text{Fe}_{0.93}\text{O}$ to $\text{Fe}_{0.96}\text{O}$. In crystals of FeO some Fe^{2+} cations are missing and the loss of positive charge is made up by the presence of required number of Fe^{3+} ions.

1.10 Electrical Properties

Solids exhibit an amazing range of electrical conductivities, extending over 27 orders of magnitude ranging from 10^{-20} to $10^7 \text{ ohm}^{-1} \text{ m}^{-1}$. Solids can be classified into three types on the basis of their conductivities.

- Conductors:* The solids with conductivities ranging between 10^4 to $10^7 \text{ ohm}^{-1} \text{ m}^{-1}$ are called conductors. Metals have conductivities in the order of $10^7 \text{ ohm}^{-1} \text{ m}^{-1}$ are good conductors.

- (ii) *Insulators* : These are the solids with very low conductivities ranging between 10^{-20} to 10^{-10} $\text{ohm}^{-1}\text{m}^{-1}$.
- (iii) *Semiconductors* : These are the solids with conductivities in the intermediate range from 10^{-6} to 10^4 $\text{ohm}^{-1}\text{m}^{-1}$.

1.10.1 Conduction of Electricity in Metals

A conductor may conduct electricity through movement of electrons or ions. Metallic conductors belong to the former category and electrolytes to the latter.

Metals conduct electricity in solid as well as molten state. The conductivity of metals depend upon the number of valence electrons available per atom. The atomic orbitals of metal atoms form molecular orbitals which are so close in energy to each other as to form a **band**. If this band is partially filled or it overlaps with a higher energy unoccupied conduction band, then electrons can flow easily under an applied electric field and the metal shows conductivity (Fig. 1.29 a).

If the gap between filled valence band and the next higher unoccupied band (conduction band) is large, electrons cannot jump to it and such a substance has very small conductivity and it behaves as an insulator (Fig. 1.29 b).

1.10.2 Conduction of Electricity in Semiconductors

In case of semiconductors, the gap between the valence band and conduction band is small (Fig. 1.29c). Therefore, some electrons may jump to conduction band and show some conductivity. Electrical conductivity of semiconductors increases with rise in temperature, since more electrons can jump to the conduction band. Substances like silicon and germanium show this type of behaviour and are called *intrinsic semiconductors*.

The conductivity of these intrinsic semiconductors is too low to be of practical use. Their conductivity is increased by adding an appropriate amount of suitable impurity. This process is called

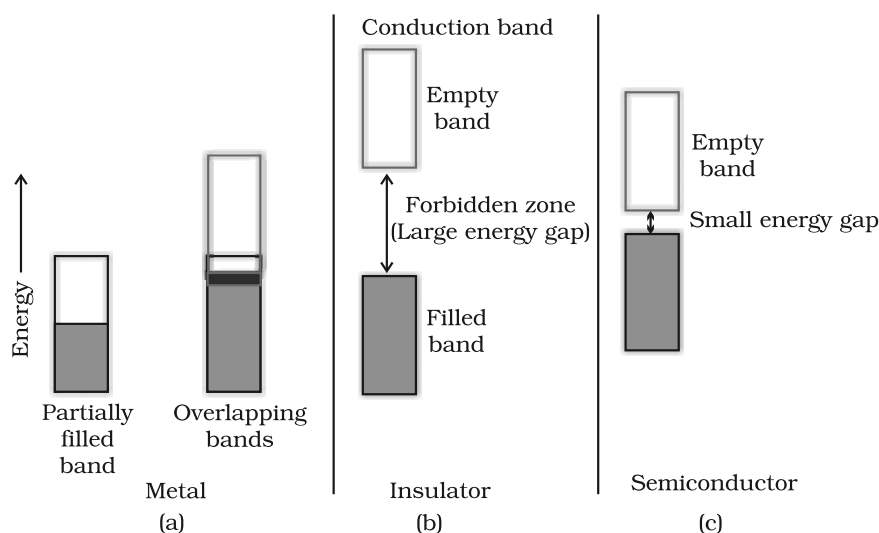

Fig. 1.29
Distinction among
(a) metals
(b) insulators and
(c) semiconductors.
In each case, an
unshaded area
represents a
conduction band.

doping. Doping can be done with an impurity which is electron rich or electron deficient as compared to the intrinsic semiconductor silicon or germanium. Such impurities introduce *electronic defects* in them.

(a) Electron - rich impurities

Silicon and germanium belong to group 14 of the periodic table and have four valence electrons each. In their crystals each atom forms four covalent bonds with its neighbours (Fig. 1.30 a). When doped with a group 15 element like P or As, which contains five valence electrons, they occupy some of the lattice sites in silicon or germanium crystal (Fig. 1.30 b). Four out of five electrons are used in the formation of four covalent bonds with the four neighbouring silicon atoms. The fifth electron is extra and becomes delocalised. These delocalised electrons increase the conductivity of doped silicon (or germanium). Here the increase in conductivity is due to the *negatively* charged electron, hence silicon doped with electron-rich impurity is called *n-type* semiconductor.

(b) Electron - deficit impurities

Silicon or germanium can also be doped with a group 13 element like B, Al or Ga which contains only three valence electrons. The place where the fourth valence electron is missing is called *electron hole* or *electron vacancy* (Fig. 1.30 c). An electron from a neighbouring atom can come and fill the electron hole, but in doing so it would leave an electron hole at its original position. If it happens, it would appear as if the electron hole has moved in the direction opposite to that of the electron that filled it. Under the influence of electric field, electrons would move towards the positively charged plate through electronic holes, but it would appear as if electron holes are positively charged and are moving towards negatively charged plate. This type of semi conductors are called *p-type* semiconductors.

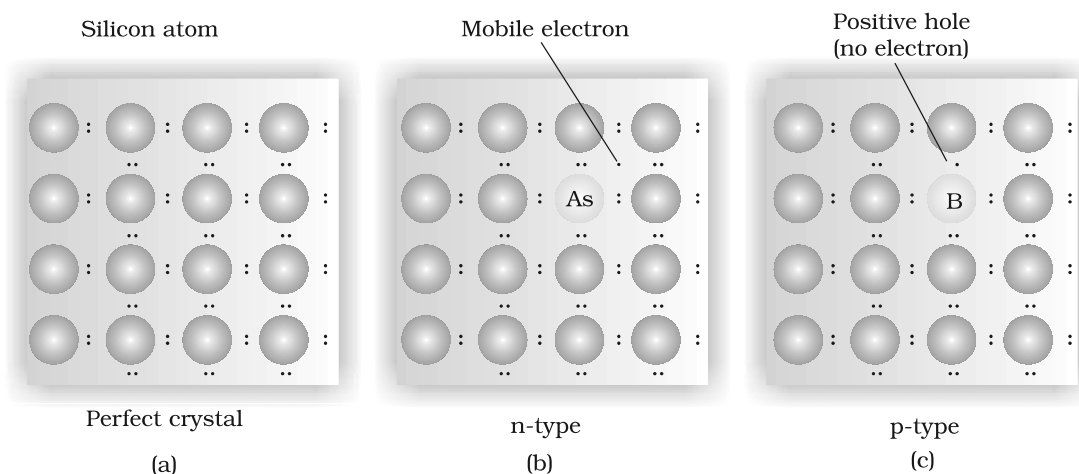

Fig. 1.30: Creation of *n-type* and *p-type* semiconductors by doping groups 13 and 15 elements.

11.1 Magnetic Properties

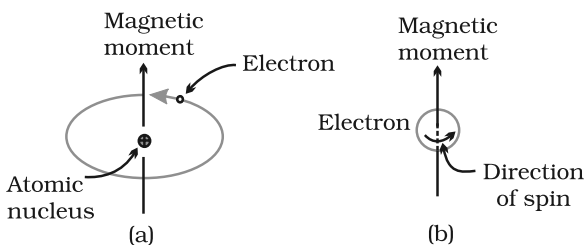

Fig.1.31: Demonstration of the magnetic moment associated with (a) an orbiting electron and (b) a spinning electron.

Applications of *n*-type and *p*-type semiconductors

Various combinations of *n*-type and *p*-type semiconductors are used for making electronic components. *Diode* is a combination of *n*-type and *p*-type semiconductors and is used as a rectifier. Transistors are made by sandwiching a layer of one type of semiconductor between two layers of the other type of semiconductor. *npn* and *pnp* type of transistors are used to detect or amplify radio or audio signals. The solar cell is an efficient photo-diode used for conversion of light energy into electrical energy.

Germanium and silicon are group 14 elements and therefore, have a characteristic valence of four and form four bonds as in diamond. A large variety of solid state materials have been prepared by combination of groups 13 and 15 or 12 and 16 to simulate average valence of four as in Ge or Si. Typical compounds of groups 13 – 15 are InSb, AlP and GaAs. Gallium arsenide (GaAs) semiconductors have very fast response and have revolutionised the design of semiconductor devices. ZnS, CdS, CdSe and HgTe are examples of groups 12 – 16 compounds. In these compounds, the bonds are not perfectly covalent and the ionic character depends on the electronegativities of the two elements.

It is interesting to learn that transition metal oxides show marked differences in electrical properties. TiO, CrO₂ and ReO₃ behave like metals. Rhenium oxide, ReO₃ is like metallic copper in its conductivity and appearance. Certain other oxides like VO, VO₂, VO₃ and TiO₃ show metallic or insulating properties depending on temperature.

Every substance has some magnetic properties associated with it. The origin of these properties lies in the electrons. Each electron in an atom behaves like a tiny magnet. Its magnetic moment originates

from two types of motions (i) its orbital motion around the nucleus and (ii) its spin around its own axis (Fig. 1.31). Electron being a charged particle and undergoing these motions can be considered as a small loop of current which possesses a magnetic moment. Thus, each electron has a permanent spin and an orbital magnetic moment associated with it. Magnitude of this magnetic moment is very small and is measured in the unit called *Bohr magneton*, μ_B . It is equal to $9.27 \times 10^{-24} \text{A m}^2$.

On the basis of their magnetic properties, substances can be classified into five categories: (i) paramagnetic (ii) diamagnetic (iii) ferromagnetic (iv) antiferromagnetic and (v) ferrimagnetic.

- (i) **Paramagnetism:** Paramagnetic substances are weakly attracted by a magnetic field. They are magnetised in a magnetic field in the same direction. They lose their magnetism in the absence of magnetic field. Paramagnetism is due to presence of one or more unpaired electrons which are attracted by the magnetic field. O₂, Cu²⁺, Fe³⁺, Cr³⁺ are some examples of such substances.

- (ii) **Diamagnetism:** Diamagnetic substances are weakly repelled by a magnetic field. H_2O , NaCl and C_6H_6 are some examples of such substances. They are weakly magnetised in a magnetic field in opposite direction. Diamagnetism is shown by those substances in which all the electrons are paired and there are no unpaired electrons. Pairing of electrons cancels their magnetic moments and they lose their magnetic character.
- (iii) **Ferromagnetism:** A few substances like iron, cobalt, nickel, gadolinium and CrO_2 are attracted very strongly by a magnetic field. Such substances are called ferromagnetic substances. Besides strong attractions, these substances can be permanently magnetised. In solid state, the metal ions of ferromagnetic substances are grouped together into small regions called *domains*. Thus, each domain acts as a tiny magnet. In an unmagnetised piece of a ferromagnetic substance the domains are randomly oriented and their magnetic moments get cancelled. When the substance is placed in a magnetic field all the domains get oriented in the direction of the magnetic field (Fig. 1.32 a) and a strong magnetic effect is produced. This ordering of domains persists even when the magnetic field is removed and the ferromagnetic substance becomes a permanent magnet.
- (iv) **Antiferromagnetism:** Substances like MnO showing antiferromagnetism have domain structure similar to ferromagnetic substance, but their domains are oppositely oriented and cancel out each other's magnetic moment (Fig. 1.32 b).
- (v) **Ferrimagnetism:** Ferrimagnetism is observed when the magnetic moments of the domains in the substance are aligned in parallel and anti-parallel directions in unequal numbers (Fig. 1.32 c). They are weakly attracted by magnetic field as compared to ferromagnetic substances. Fe_3O_4 (magnetite) and ferrites like MgFe_2O_4 and ZnFe_2O_4 are examples of such substances. These substances also lose ferrimagnetism on heating and become paramagnetic.

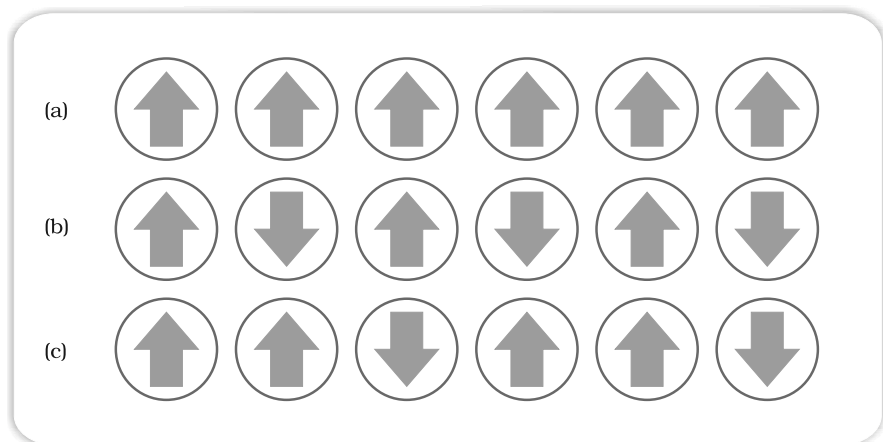

Fig 1.32: Schematic alignment of magnetic moments in (a) ferromagnetic (b) antiferromagnetic and (c) ferrimagnetic.

Intext Questions

- 1.19** What type of defect can arise when a solid is heated? Which physical property is affected by it and in what way?
- 1.20** What type of stoichiometric defect is shown by:
(i) ZnS (ii) AgBr
- 1.21** Explain how vacancies are introduced in an ionic solid when a cation of higher valence is added as an impurity in it.
- 1.22** Ionic solids, which have anionic vacancies due to metal excess defect, develop colour. Explain with the help of a suitable example.
- 1.23** A group 14 element is to be converted into n-type semiconductor by doping it with a suitable impurity. To which group should this impurity belong?
- 1.24** What type of substances would make better permanent magnets, ferromagnetic or ferrimagnetic. Justify your answer.

Summary

Solids have definite mass, volume and shape. This is due to the fixed position of their constituent particles, short distances and strong interactions between them. In **amorphous** solids, the arrangement of constituent particles has only **short range order** and consequently they behave like **super cooled liquids**, do not have sharp melting points and are isotropic in nature. In crystalline solids there is long range order in the arrangement of their constituent particles. They have sharp melting points, are anisotropic in nature and their particles have characteristic shapes. Properties of **crystalline** solids depend upon the nature of interactions between their constituent particles. On this basis, they can be divided into four categories, namely: **molecular**, **ionic**, **metallic** and **covalent** solids. They differ widely in their properties.

The constituent particles in crystalline solids are arranged in a regular pattern which extends throughout the crystal. This arrangement is often depicted in the form of a three dimensional array of points which is called crystal lattice. Each **lattice point** gives the location of one particle in space. In all, fourteen different types of lattices are possible which are called **Bravais lattices**. Each lattice can be generated by repeating its small characteristic portion called **unit cell**. A unit cell is characterised by its edge lengths and three angles between these edges. Unit cells can be either **primitive** which have particles only at their corner positions or **centred**. The centred unit cells have additional particles at their body centre (**body-centred**), at the centre of each face (**face-centred**) or at the centre of two opposite faces (**end-centred**). There are seven types of **primitive unit** cells. Taking centred unit cells also into account, there are fourteen types of unit cells in all, which result in fourteen **Bravais lattices**.

Close-packing of particles result in two highly efficient lattices, **hexagonal close-packed (hcp)** and **cubic close-packed (ccp)**. The latter is also called face-centred cubic (**fcc**) lattice. In both of these packings 74% space is filled. The remaining space is present in the form of two types of voids-octahedral voids and tetrahedral voids. Other types of packing are not close-packings and have less

efficient packing of particles. While in **body-centred cubic lattice (bcc)** 68% space is filled, in simple cubic lattice only 52.4 % space is filled.

Solids are not perfect in structure. There are different types of **imperfections** or **defects** in them. Point defects and line defects are common types of defects. Point defects are of three types - **stoichiometric defects, impurity defects and non-stoichiometric defects**. **Vacancy defects** and **interstitial defects** are the two basic types of stoichiometric point defects. In ionic solids, these defects are present as **Frenkel** and **Schottky defects**. Impurity defects are caused by the presence of an impurity in the crystal. In ionic solids, when the ionic impurity has a different valence than the main compound, some vacancies are created. Non-stoichiometric defects are of metal excess type and metal deficient type. Sometimes calculated amounts of impurities are introduced by **doping in semiconductors** that change their electrical properties. Such materials are widely used in electronics industry. Solids show many types of magnetic properties like **paramagnetism, diamagnetism, ferromagnetism, antiferromagnetism** and **ferrimagnetism**. These properties are used in audio, video and other recording devices. All these properties can be correlated with their electronic configurations or structures.

Exercises

- 1.1 Define the term 'amorphous'. Give a few examples of amorphous solids.
- 1.2 What makes a glass different from a solid such as quartz? Under what conditions could quartz be converted into glass?
- 1.3 Classify each of the following solids as ionic, metallic, molecular, network (covalent) or amorphous.
 - (i) Tetra phosphorus decoxide (P_4O_{10})
 - (ii) Ammonium phosphate ($(NH_4)_3PO_4$)
 - (iii) SiC
 - (iv) I_2
 - (v) P_4
 - (vi) Plastic
 - (vii) Graphite
 - (viii) Brass
 - (ix) Rb
 - (x) LiBr
 - (xi) Si
- 1.4
 - (i) What is meant by the term 'coordination number'?
 - (ii) What is the coordination number of atoms:
 - (a) in a cubic close-packed structure?
 - (b) in a body-centred cubic structure?
- 1.5 How can you determine the atomic mass of an unknown metal if you know its density and the dimension of its unit cell? Explain.
- 1.6 'Stability of a crystal is reflected in the magnitude of its melting points'. Comment. Collect melting points of solid water, ethyl alcohol, diethyl ether and methane from a data book. What can you say about the intermolecular forces between these molecules?

- 1.7 How will you distinguish between the following pairs of terms:
- Hexagonal close-packing and cubic close-packing?
 - Crystal lattice and unit cell?
 - Tetrahedral void and octahedral void?
- 1.8 How many lattice points are there in one unit cell of each of the following lattice?
- Face-centred cubic
 - Face-centred tetragonal
 - Body-centred
- 1.9 Explain
- The basis of similarities and differences between metallic and ionic crystals.
 - Ionic solids are hard and brittle.
- 1.10 Calculate the efficiency of packing in case of a metal crystal for
- simple cubic
 - body-centred cubic
 - face-centred cubic (with the assumptions that atoms are touching each other).
- 1.11 Silver crystallises in fcc lattice. If edge length of the cell is 4.07×10^{-8} cm and density is 10.5 g cm^{-3} , calculate the atomic mass of silver.
- 1.12 A cubic solid is made of two elements P and Q. Atoms of Q are at the corners of the cube and P at the body-centre. What is the formula of the compound? What are the coordination numbers of P and Q?
- 1.13 Niobium crystallises in body-centred cubic structure. If density is 8.55 g cm^{-3} , calculate atomic radius of niobium using its atomic mass 93 u.
- 1.14 If the radius of the octahedral void is r and radius of the atoms in close-packing is R , derive relation between r and R .
- 1.15 Copper crystallises into a fcc lattice with edge length 3.61×10^{-8} cm. Show that the calculated density is in agreement with its measured value of 8.92 g cm^{-3} .
- 1.16 Analysis shows that nickel oxide has the formula $\text{NiO}_{.98}\text{O}_{1.00}$. What fractions of nickel exist as Ni^{2+} and Ni^{3+} ions?
- 1.17 What is a semiconductor? Describe the two main types of semiconductors and contrast their conduction mechanism.
- 1.18 Non-stoichiometric cuprous oxide, Cu_2O can be prepared in laboratory. In this oxide, copper to oxygen ratio is slightly less than 2:1. Can you account for the fact that this substance is a p-type semiconductor?
- 1.19 Ferric oxide crystallises in a hexagonal close-packed array of oxide ions with two out of every three octahedral holes occupied by ferric ions. Derive the formula of the ferric oxide.
- 1.20 Classify each of the following as being either a p-type or a n-type semiconductor:
- Ge doped with In
 - B doped with Si.

- 1.21 Gold (atomic radius = 0.144 nm) crystallises in a face-centred unit cell. What is the length of a side of the cell?
- 1.22 In terms of band theory, what is the difference
(i) between a conductor and an insulator
(ii) between a conductor and a semiconductor?
- 1.23 Explain the following terms with suitable examples:
(i) Schottky defect (ii) Frenkel defect (iii) Interstitials and (iv) F-centres.
- 1.24 Aluminium crystallises in a cubic close-packed structure. Its metallic radius is 125 pm.
(i) What is the length of the side of the unit cell?
(ii) How many unit cells are there in 1.00 cm³ of aluminium?
- 1.25 If NaCl is doped with 10⁻³ mol % of SrCl₂, what is the concentration of cation vacancies?
- 1.26 Explain the following with suitable examples:
(i) Ferromagnetism
(ii) Paramagnetism
(iii) Ferrimagnetism
(iv) Antiferromagnetism
(v) 12-16 and 13-15 group compounds.

Answers to Some Intext Questions

- 1.14 4
- 1.15 Total number of voids = 9.033×10^{23}
Number of tetrahedral voids = 6.022×10^{23}
- 1.16 M₂N₃
- 1.18 ccp

Unit 2 Solutions

Objectives

After studying this Unit, you will be able to

- describe the formation of different types of solutions;
- express concentration of solution in different units;
- state and explain Henry's law and Raoult's law;
- distinguish between ideal and non-ideal solutions;
- explain deviations of real solutions from Raoult's law;
- describe colligative properties of solutions and correlate these with molar masses of the solutes;
- explain abnormal colligative properties exhibited by some solutes in solutions.

Almost all processes in body occur in some kind of liquid solutions.

In normal life we rarely come across pure substances. Most of these are mixtures containing two or more pure substances. Their utility or importance in life depends on their composition. For example, the properties of brass (mixture of copper and zinc) are quite different from those of German silver (mixture of copper, zinc and nickel) or bronze (mixture of copper and tin); 1 part per million (ppm) of fluoride ions in water prevents tooth decay, while 1.5 ppm causes the tooth to become mottled and high concentrations of fluoride ions can be poisonous (for example, sodium fluoride is used in rat poison); intravenous injections are always dissolved in water containing salts at particular ionic concentrations that match with blood plasma concentrations and so on.

In this Unit, we will consider mostly liquid solutions and their formation. This will be followed by studying the properties of the solutions, like vapour pressure and colligative properties. We will begin with types of solutions and then various alternatives in which concentrations of a solute can be expressed in liquid solution.

2.1 Types of Solutions

Solutions are **homogeneous** mixtures of two or more than two components. By homogenous mixture we mean that its composition and properties are uniform throughout the mixture. Generally, the component that is present in the largest quantity is known as **solvent**. Solvent determines the physical state in which solution exists. One or more components present in the solution other than solvent are called **solutes**. In this Unit we shall consider only **binary solutions** (i.e.,

consisting of two components). Here each component may be solid, liquid or in gaseous state and are summarised in Table 2.1.

Table 2.1: Types of Solutions

Type of Solution	Solute	Solvent	Common Examples
<i>Gaseous Solutions</i>	Gas	Gas	Mixture of oxygen and nitrogen gases
	Liquid	Gas	Chloroform mixed with nitrogen gas
	Solid	Gas	Camphor in nitrogen gas
<i>Liquid Solutions</i>	Gas	Liquid	Oxygen dissolved in water
	Liquid	Liquid	Ethanol dissolved in water
	Solid	Liquid	Glucose dissolved in water
<i>Solid Solutions</i>	Gas	Solid	Solution of hydrogen in palladium
	Liquid	Solid	Amalgam of mercury with sodium
	Solid	Solid	Copper dissolved in gold

2.2 Expressing Concentration of Solutions

Composition of a solution can be described by expressing its concentration. The latter can be expressed either qualitatively or quantitatively. For example, qualitatively we can say that the solution is dilute (i.e., relatively very small quantity of solute) or it is concentrated (i.e., relatively very large quantity of solute). But in real life these kinds of description can add to lot of confusion and thus the need for a quantitative description of the solution.

There are several ways by which we can describe the concentration of the solution quantitatively.

- (i) *Mass percentage (w/w)*: The mass percentage of a component of a solution is defined as:

Mass % of a component

$$= \frac{\text{Mass of the component in the solution}}{\text{Total mass of the solution}} \times 100 \quad (2.1)$$

For example, if a solution is described by 10% glucose in water by mass, it means that 10 g of glucose is dissolved in 90 g of water resulting in a 100 g solution. Concentration described by mass percentage is commonly used in industrial chemical applications. For example, commercial bleaching solution contains 3.62 mass percentage of sodium hypochlorite in water.

- (ii) *Volume percentage (v/v)*: The volume percentage is defined as:

$$\text{Volume \% of a component} = \frac{\text{Volume of the component}}{\text{Total volume of solution}} \times 100 \quad (2.2)$$

For example, 10% ethanol solution in water means that 10 mL of ethanol is dissolved in water such that the total volume of the solution is 100 mL. Solutions containing liquids are commonly expressed in this unit. For example, a 35% (*v/v*) solution of ethylene glycol, an antifreeze, is used in cars for cooling the engine. At this concentration the antifreeze lowers the freezing point of water to 255.4K (-17.6°C).

(iii) *Mass by volume percentage (w/v)*: Another unit which is commonly used in medicine and pharmacy is mass by volume percentage. It is the mass of solute dissolved in 100 mL of the solution.

(iv) *Parts per million*: When a solute is present in **trace** quantities, it is convenient to express concentration in **parts per million (ppm)** and is defined as:

Parts per million =

$$= \frac{\text{Number of parts of the component}}{\text{Total number of parts of all components of the solution}} \times 10^6 \quad (2.3)$$

As in the case of percentage, concentration in parts per million can also be expressed as mass to mass, volume to volume and mass to volume. A litre of sea water (which weighs 1030 g) contains about 6×10^{-3} g of dissolved oxygen (O_2). Such a small concentration is also expressed as 5.8 g per 10^6 g (5.8 ppm) of sea water. The concentration of pollutants in water or atmosphere is often expressed in terms of $\mu\text{g mL}^{-1}$ or ppm.

(v) *Mole fraction*: Commonly used symbol for mole fraction is x and subscript used on the right hand side of x denotes the component. It is defined as:

Mole fraction of a component =

$$\frac{\text{Number of moles of the component}}{\text{Total number of moles of all the components}} \quad (2.4)$$

For example, in a binary mixture, if the number of moles of A and B are n_A and n_B respectively, the mole fraction of A will be

$$x_A = \frac{n_A}{n_A + n_B} \quad (2.5)$$

For a solution containing i number of components, we have:

$$x_i = \frac{n_i}{n_1 + n_2 + \dots + n_i} = \frac{n_i}{\sum n_i} \quad (2.6)$$

It can be shown that in a given solution sum of all the mole fractions is unity, i.e.

$$x_1 + x_2 + \dots + x_i = 1 \quad (2.7)$$

Mole fraction unit is very useful in relating some physical properties of solutions, say vapour pressure with the concentration of the solution and quite useful in describing the calculations involving gas mixtures.

Example 2.1 Calculate the mole fraction of ethylene glycol ($C_2H_6O_2$) in a solution containing 20% of $C_2H_6O_2$ by mass.

Solution Assume that we have 100 g of solution (one can start with any amount of solution because the results obtained will be the same). Solution will contain 20 g of ethylene glycol and 80 g of water.

Molar mass of $C_2H_6O_2 = 12 \times 2 + 1 \times 6 + 16 \times 2 = 62 \text{ g mol}^{-1}$.

$$\text{Moles of } C_2H_6O_2 = \frac{20 \text{ g}}{62 \text{ g mol}^{-1}} = 0.322 \text{ mol}$$

$$\text{Moles of water} = \frac{80 \text{ g}}{18 \text{ g mol}^{-1}} = 4.444 \text{ mol}$$

$$\begin{aligned} x_{\text{glycol}} &= \frac{\text{moles of } C_2H_6O_2}{\text{moles of } C_2H_6O_2 + \text{moles of } H_2O} \\ &= \frac{0.322 \text{ mol}}{0.322 \text{ mol} + 4.444 \text{ mol}} = 0.068 \end{aligned}$$

$$\text{Similarly, } x_{\text{water}} = \frac{4.444 \text{ mol}}{0.322 \text{ mol} + 4.444 \text{ mol}} = 0.932$$

Mole fraction of water can also be calculated as: $1 - 0.068 = 0.932$

(vi) **Molarity:** Molarity (M) is defined as number of moles of solute dissolved in one litre (or one cubic decimetre) of solution,

$$\text{Molarity} = \frac{\text{Moles of solute}}{\text{Volume of solution in litre}} \quad (2.8)$$

For example, 0.25 mol L^{-1} (or 0.25 M) solution of NaOH means that 0.25 mol of NaOH has been dissolved in one litre (or one cubic decimetre).

Example 2.2 Calculate the molarity of a solution containing 5 g of NaOH in 450 mL solution.

Solution Moles of NaOH = $\frac{5 \text{ g}}{40 \text{ g mol}^{-1}} = 0.125 \text{ mol}$

Volume of the solution in litres = $450 \text{ mL} / 1000 \text{ mL L}^{-1}$

Using equation (2.8),

$$\begin{aligned} \text{Molarity} &= \frac{0.125 \text{ mol} \times 1000 \text{ mL L}^{-1}}{450 \text{ mL}} = 0.278 \text{ M} \\ &= 0.278 \text{ mol L}^{-1} \\ &= 0.278 \text{ mol dm}^{-3} \end{aligned}$$

(vii) **Molality:** Molality (m) is defined as the number of moles of the solute per kilogram (kg) of the solvent and is expressed as:

$$\text{Molality (m)} = \frac{\text{Moles of solute}}{\text{Mass of solvent in kg}} \quad (2.9)$$

For example, 1.00 mol kg⁻¹ (or 1.00 m) solution of KCl means that 1 mol (74.5 g) of KCl is dissolved in 1 kg of water.

Each method of expressing concentration of the solutions has its own merits and demerits. Mass %, ppm, mole fraction and molality are independent of temperature, whereas molarity is a function of temperature. This is because volume depends on temperature and the mass does not.

Calculate molality of 2.5 g of ethanoic acid (CH₃COOH) in 75 g of benzene. *Example 2.3*

Molar mass of C₂H₄O₂: 12 × 2 + 1 × 4 + 16 × 2 = 60 g mol⁻¹

$$\text{Moles of C}_2\text{H}_4\text{O}_2 = \frac{2.5 \text{ g}}{60 \text{ g mol}^{-1}} = 0.0417 \text{ mol}$$

Mass of benzene in kg = 75 g / 1000 g kg⁻¹ = 75 × 10⁻³ kg

$$\begin{aligned} \text{Molality of C}_2\text{H}_4\text{O}_2 &= \frac{\text{Moles of C}_2\text{H}_4\text{O}_2}{\text{kg of benzene}} = \frac{0.0417 \text{ mol} \times 1000 \text{ g kg}^{-1}}{75 \text{ g}} \\ &= 0.556 \text{ mol kg}^{-1} \end{aligned}$$

Solution

Intext Questions

- 2.1 Calculate the mass percentage of benzene (C₆H₆) and carbon tetrachloride (CCl₄) if 22 g of benzene is dissolved in 122 g of carbon tetrachloride.
- 2.2 Calculate the mole fraction of benzene in solution containing 30% by mass in carbon tetrachloride.
- 2.3 Calculate the molarity of each of the following solutions: (a) 30 g of Co(NO₃)₂ · 6H₂O in 4.3 L of solution (b) 30 mL of 0.5 M H₂SO₄ diluted to 500 mL.
- 2.4 Calculate the mass of urea (NH₂CONH₂) required in making 2.5 kg of 0.25 molal aqueous solution.
- 2.5 Calculate (a) molality (b) molarity and (c) mole fraction of KI if the density of 20% (mass/mass) aqueous KI is 1.202 g mL⁻¹.

2.3 Solubility

Solubility of a substance is its maximum amount that can be dissolved in a specified amount of solvent. It depends upon the nature of solute and solvent as well as temperature and pressure. Let us consider the effect of these factors in solution of a solid or a gas in a liquid.

2.3.1 Solubility of a Solid in a Liquid

Every solid does not dissolve in a given liquid. While sodium chloride and sugar dissolve readily in water, naphthalene and anthracene do not. On the other hand, naphthalene and anthracene dissolve readily in benzene but sodium chloride and sugar do not. It is observed that polar solutes dissolve in polar solvents and non polar solutes in non-polar solvents. In general, a solute dissolves in a solvent if the intermolecular interactions are similar in the two or we may say **like dissolves like**.

When a solid solute is added to the solvent, some solute dissolves and its concentration increases in solution. This process is known as dissolution. Some solute particles in solution collide with the solid solute particles and get separated out of solution. This process is known as crystallisation. A stage is reached when the two processes occur at the same rate. Under such conditions, number of solute particles going into solution will be equal to the solute particles separating out and a state of dynamic equilibrium is reached.



At this stage the concentration of solute in solution will remain constant under the given conditions, i.e., temperature and pressure. Similar process is followed when gases are dissolved in liquid solvents. Such a solution in which no more solute can be dissolved at the same temperature and pressure is called a **saturated solution**. An *unsaturated solution* is one in which more solute can be dissolved at the same temperature. The solution which is in dynamic equilibrium with undissolved solute is the saturated solution and contains the maximum amount of solute dissolved in a given amount of solvent. Thus, the concentration of solute in such a solution is its solubility.

Earlier we have observed that solubility of one substance into another depends on the nature of the substances. In addition to these variables, two other parameters, i.e., temperature and pressure also control this phenomenon.

Effect of temperature

The solubility of a solid in a liquid is significantly affected by temperature changes. Consider the equilibrium represented by equation 2.10. This, being dynamic equilibrium, must follow **Le Chateliers Principle**. In general, if in a *nearly saturated solution*, the dissolution process is endothermic ($\Delta_{\text{sol}} H > 0$), the solubility should increase with rise in temperature and if it is exothermic ($\Delta_{\text{sol}} H < 0$) the solubility should decrease. These trends are also observed experimentally.

Effect of pressure

Pressure does not have any significant effect on solubility of solids in liquids. It is so because solids and liquids are highly incompressible and practically remain unaffected by changes in pressure.

2.3.2 Solubility of a Gas in a Liquid

Many gases dissolve in water. Oxygen dissolves only to a small extent in water. It is this dissolved oxygen which sustains all aquatic life. On the other hand, hydrogen chloride gas (HCl) is highly soluble in water. Solubility of gases in liquids is greatly affected by pressure and

temperature. The solubility of gases increase with increase of pressure. For solution of gases in a solvent, consider a system as shown in Fig. 2.1 (a). The lower part is solution and the upper part is gaseous system at pressure p and temperature T . Assume this system to be in a state of dynamic equilibrium, i.e., under these conditions rate of gaseous particles entering and leaving the solution phase is the same. Now increase the pressure over the solution phase by compressing the gas to a smaller volume [Fig. 2.1 (b)]. This will increase the number of gaseous particles per unit volume over the solution and also the rate at which the gaseous particles are striking the surface of solution to enter it. The solubility of the gas will increase until a new equilibrium is reached resulting in an increase in the pressure of a gas above the solution and thus its solubility increases.

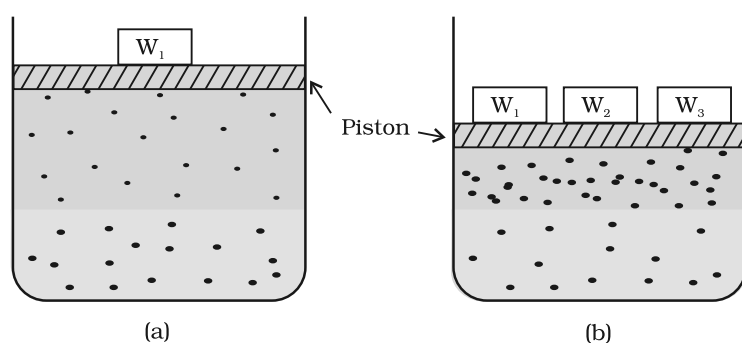

Fig. 2.1: Effect of pressure on the solubility of a gas. The concentration of dissolved gas is proportional to the pressure on the gas above the solution.

Henry was the first to give a quantitative relation between pressure and solubility of a gas in a solvent which is known as **Henry's law**. The law states that at a constant temperature, **the solubility of a gas in a liquid is directly proportional to the pressure of the gas**. Dalton, a contemporary of Henry, also concluded independently that the solubility of a gas in a liquid solution is a function of partial pressure of the gas. If we use the mole fraction of a gas in the solution as a measure of its

solubility, then it can be said that **the mole fraction of gas in the solution is proportional to the partial pressure of the gas over the solution**. The most commonly used form of Henry's law states that **"the partial pressure of the gas in vapour phase (p) is proportional to the mole fraction of the gas (x) in the solution"** and is expressed as:

$$p = K_H x \quad (2.11)$$

Here K_H is the Henry's law constant. If we draw a graph between partial pressure of the gas versus mole fraction of the gas in solution, then we should get a plot of the type as shown in Fig. 2.2.

Different gases have different K_H values at the same temperature (Table 2.2). This suggests that K_H is a function of the nature of the gas.

It is obvious from equation (2.11) that higher the value of K_H at a given pressure, the lower is the solubility of the gas in the liquid. It can be seen from Table 2.2 that K_H values for both N_2 and O_2 increase with increase of temperature indicating that the solubility of gases

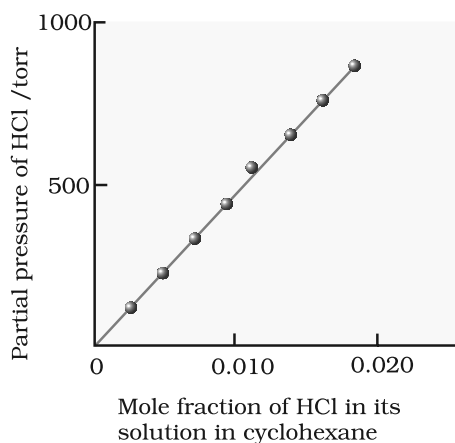

Fig. 2.2: Experimental results for the solubility of HCl gas in cyclohexane at 293 K. The slope of the line is the Henry's Law constant, K_H .

Table 2.2: Values of Henry's Law Constant for Some Selected Gases in Water

Gas	Temperature/K	K_H /kbar	Gas	Temperature/K	K_H /kbar
He	293	144.97	Argon	298	40.3
H ₂	293	69.16	CO ₂	298	1.67
N ₂	293	76.48	Formaldehyde	298	1.83×10 ⁻⁵
N ₂	303	88.84	Methane	298	0.413
O ₂	293	34.86	Vinyl chloride	298	0.611
O ₂	303	46.82			

increases with decrease of temperature. It is due to this reason that aquatic species are more comfortable in cold waters rather than in warm waters.

Example 2.4 If N₂ gas is bubbled through water at 293 K, how many millimoles of N₂ gas would dissolve in 1 litre of water. Assume that N₂ exerts a partial pressure of 0.987 bar. Given that Henry's law constant for N₂ at 293 K is 76.48 kbar.

Solution The solubility of gas is related to the mole fraction in aqueous solution. The mole fraction of the gas in the solution is calculated by applying Henry's law. Thus:

$$x(\text{Nitrogen}) = \frac{p(\text{nitrogen})}{K_H} = \frac{0.987\text{bar}}{76,480\text{ bar}} = 1.29 \times 10^{-5}$$

As 1 litre of water contains 55.5 mol of it, therefore if n represents number of moles of N₂ in solution,

$$x(\text{Nitrogen}) = \frac{n\text{ mol}}{n\text{ mol} + 55.5\text{ mol}} = \frac{n}{55.5} = 1.29 \times 10^{-5}$$

(n in denominator is neglected as it is $\ll 55.5$)

Thus $n = 1.29 \times 10^{-5} \times 55.5\text{ mol} = 7.16 \times 10^{-4}\text{ mol}$

$$= \frac{7.16 \times 10^{-4}\text{ mol} \times 1000\text{ mol}}{1\text{ mol}} = 0.716\text{ mmol}$$

Henry's law finds several applications in industry and explains some biological phenomena. Notable among these are:

- To increase the solubility of CO₂ in soft drinks and soda water, the bottle is sealed under high pressure.
- Scuba divers must cope with high concentrations of dissolved gases while breathing air at high pressure underwater. Increased pressure increases the solubility of atmospheric gases in blood. When the divers come towards surface, the pressure gradually decreases. This releases the dissolved gases and leads to the formation of bubbles of nitrogen in the blood. This blocks capillaries and creates a medical condition known as *bends*, which are painful and dangerous to life.

To avoid bends, as well as, the toxic effects of high concentrations of nitrogen in the blood, the tanks used by scuba divers are filled with air diluted with helium (11.7% helium, 56.2% nitrogen and 32.1% oxygen).

- At high altitudes the partial pressure of oxygen is less than that at the ground level. This leads to low concentrations of oxygen in the blood and tissues of people living at high altitudes or climbers. Low blood oxygen causes climbers to become weak and unable to think clearly, symptoms of a condition known as *anoxia*.

Effect of Temperature

Solubility of gases in liquids decreases with rise in temperature. When dissolved, the gas molecules are present in liquid phase and the process of dissolution can be considered similar to condensation and heat is evolved in this process. We have learnt in the last Section that dissolution process involves dynamic equilibrium and thus must follow Le Chatelier's Principle. As dissolution is an exothermic process, the solubility should decrease with increase of temperature.

Intext Questions

- 2.6** H_2S , a toxic gas with rotten egg like smell, is used for the qualitative analysis. If the solubility of H_2S in water at STP is 0.195 m, calculate Henry's law constant.
- 2.7** Henry's law constant for CO_2 in water is 1.67×10^8 Pa at 298 K. Calculate the quantity of CO_2 in 500 mL of soda water when packed under 2.5 atm CO_2 pressure at 298 K.

2.4 Vapour Pressure of Liquid Solutions

Liquid solutions are formed when solvent is a liquid. The solute can be a gas, a liquid or a solid. Solutions of gases in liquids have already been discussed in Section 2.3.2. In this Section, we shall discuss the solutions of liquids and solids in a liquid. Such solutions may contain one or more volatile components. Generally, the liquid solvent is volatile. The solute may or may not be volatile. We shall discuss the properties of only binary solutions, that is, the solutions containing two components, namely, the solutions of (i) liquids in liquids and (ii) solids in liquids.

2.4.1 Vapour Pressure of Liquid-Liquid Solutions

Let us consider a binary solution of two volatile liquids and denote the two components as 1 and 2. When taken in a closed vessel, both the components would evaporate and eventually an equilibrium would be established between vapour phase and the liquid phase. Let the total vapour pressure at this stage be p_{total} and p_1 and p_2 be the partial vapour pressures of the two components 1 and 2 respectively. These partial pressures are related to the mole fractions x_1 and x_2 of the two components 1 and 2 respectively.

The French chemist, Francois Marte Raoult (1886) gave the quantitative relationship between them. The relationship is known as the **Raoult's law** which states that **for a solution of volatile liquids,**

the partial vapour pressure of each component in the solution is directly proportional to its mole fraction.

Thus, for component 1

$$p_1 \propto x_1$$

$$\text{and } p_1 = p_1^0 x_1 \quad (2.12)$$

where p_1^0 is the vapour pressure of pure component 1 at the same temperature.

Similarly, for component 2

$$p_2 = p_2^0 x_2 \quad (2.13)$$

where p_2^0 represents the vapour pressure of the pure component 2.

According to **Dalton's law of partial pressures**, the total pressure (p_{total}) over the solution phase in the container will be the sum of the partial pressures of the components of the solution and is given as:

$$p_{\text{total}} = p_1 + p_2 \quad (2.14)$$

Substituting the values of p_1 and p_2 , we get

$$\begin{aligned} p_{\text{total}} &= x_1 p_1^0 + x_2 p_2^0 \\ &= (1 - x_2) p_1^0 + x_2 p_2^0 \end{aligned} \quad (2.15)$$

$$= p_1^0 + (p_2^0 - p_1^0) x_2 \quad (2.16)$$

Following conclusions can be drawn from equation (2.16).

- (i) Total vapour pressure over the solution can be related to the mole fraction of any one component.
- (ii) Total vapour pressure over the solution varies linearly with the mole fraction of component 2.

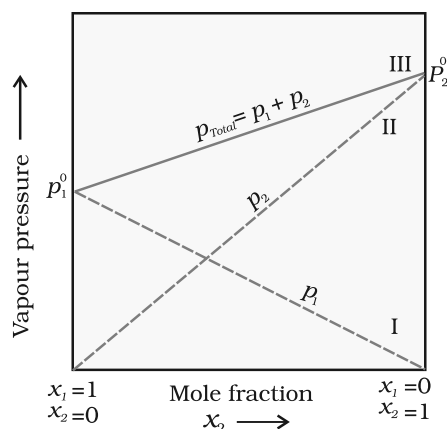

Fig. 2.3: The plot of vapour pressure and mole fraction of an ideal solution at constant temperature. The dashed lines I and II represent the partial pressure of the components. (It can be seen from the plot that p_1 and p_2 are directly proportional to x_1 and x_2 , respectively). The total vapour pressure is given by line marked III in the figure.

- (iii) Depending on the vapour pressures of the pure components 1 and 2, total vapour pressure over the solution decreases or increases with the increase of the mole fraction of component 1.

A plot of p_1 or p_2 versus the mole fractions x_1 and x_2 for a solution gives a linear plot as shown in Fig. 2.3. These lines (I and II) pass through the points and respectively when x_1 and x_2 equal unity. Similarly the plot (line III) of p_{total} versus x_2 is also linear (Fig. 2.3). The minimum value of p_{total} is p_1^0 and the maximum value is p_2^0 , assuming that component 1 is less volatile than component 2, i.e., $p_1^0 < p_2^0$.

The composition of vapour phase in equilibrium with the solution is determined by the partial pressures of the components. If y_1 and y_2 are the mole fractions of the

components 1 and 2 respectively in the vapour phase then, using Dalton's law of partial pressures:

$$p_1 = y_1 p_{\text{total}} \quad (2.17)$$

$$p_2 = y_2 p_{\text{total}} \quad (2.18)$$

In general

$$p_i = y_i p_{\text{total}} \quad (2.19)$$

Vapour pressure of chloroform (CHCl_3) and dichloromethane (CH_2Cl_2) at 298 K are 200 mm Hg and 415 mm Hg respectively. (i) Calculate the vapour pressure of the solution prepared by mixing 25.5 g of CHCl_3 and 40 g of CH_2Cl_2 at 298 K and, (ii) mole fractions of each component in vapour phase.

Example 2.5

Solution

(i) Molar mass of $\text{CH}_2\text{Cl}_2 = 12 \times 1 + 1 \times 2 + 35.5 \times 2 = 85 \text{ g mol}^{-1}$

Molar mass of $\text{CHCl}_3 = 12 \times 1 + 1 \times 1 + 35.5 \times 3 = 119.5 \text{ g mol}^{-1}$

$$\text{Moles of } \text{CH}_2\text{Cl}_2 = \frac{40 \text{ g}}{85 \text{ g mol}^{-1}} = 0.47 \text{ mol}$$

$$\text{Moles of } \text{CHCl}_3 = \frac{25.5 \text{ g}}{119.5 \text{ g mol}^{-1}} = 0.213 \text{ mol}$$

Total number of moles = $0.47 + 0.213 = 0.683 \text{ mol}$

$$x_{\text{CH}_2\text{Cl}_2} = \frac{0.47 \text{ mol}}{0.683 \text{ mol}} = 0.688$$

$$x_{\text{CHCl}_3} = 1.00 - 0.688 = 0.312$$

Using equation (2.16),

$$\begin{aligned} p_{\text{total}} &= p_1^0 + (p_2^0 - p_1^0) x_2 = 200 + (415 - 200) \times 0.688 \\ &= 200 + 147.9 = 347.9 \text{ mm Hg} \end{aligned}$$

(ii) Using the relation (2.17), $y_i = p_i/p_{\text{total}}$, we can calculate the mole fraction of the components in gas phase (y_i).

$$p_{\text{CH}_2\text{Cl}_2} = 0.688 \times 415 \text{ mm Hg} = 285.5 \text{ mm Hg}$$

$$p_{\text{CHCl}_3} = 0.312 \times 200 \text{ mm Hg} = 62.4 \text{ mm Hg}$$

$$y_{\text{CH}_2\text{Cl}_2} = 285.5 \text{ mm Hg} / 347.9 \text{ mm Hg} = 0.82$$

$$y_{\text{CHCl}_3} = 62.4 \text{ mm Hg} / 347.9 \text{ mm Hg} = 0.18$$

Note: Since, CH_2Cl_2 is a more volatile component than CHCl_3 , [$p_{\text{CH}_2\text{Cl}_2}^0 = 415 \text{ mm Hg}$ and $p_{\text{CHCl}_3}^0 = 200 \text{ mm Hg}$] and the vapour phase is also richer in CH_2Cl_2 [$y_{\text{CH}_2\text{Cl}_2} = 0.82$ and $y_{\text{CHCl}_3} = 0.18$], it may thus be concluded that **at equilibrium, vapour phase will be always rich in the component which is more volatile.**

2.4.2 Raoult's Law as a special case of Henry's Law

According to Raoult's law, the vapour pressure of a volatile component in a given solution is given by $p_1 = x_1 p_1^0$. In the solution of a gas in a liquid, one of the components is so volatile that it exists as a gas and we have already seen that its solubility is given by Henry's law which states that

$$p = K_H x.$$

If we compare the equations for Raoult's law and Henry's law, it can be seen that the partial pressure of the volatile component or gas is directly proportional to its mole fraction in solution. Only the proportionality constant K_H differs from p_1^0 . Thus, Raoult's law becomes a special case of Henry's law in which K_H becomes equal to p_1^0 .

2.4.3 Vapour Pressure of Solutions of Solids in Liquids

Another important class of solutions consists of solids dissolved in liquid, for example, sodium chloride, glucose, urea and cane sugar in water and iodine and sulphur dissolved in carbon disulphide. Some physical properties of these solutions are quite different from those of pure solvents. For example, vapour pressure. We have learnt in Unit 5, Class XI, that liquids at a given temperature vapourise and under equilibrium conditions the pressure exerted by the vapours of the liquid over the liquid phase is called vapour pressure [Fig. 2.4 (a)].

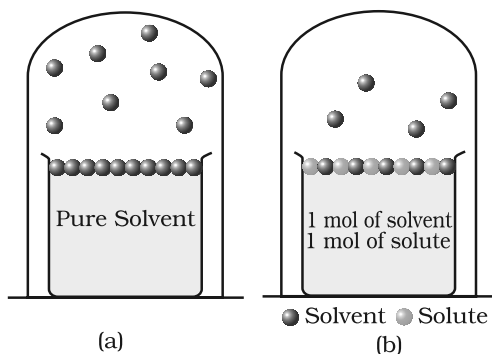

Fig. 2.4: Decrease in the vapour pressure of the solvent on account of the presence of solute in the solvent (a) evaporation of the molecules of the solvent from its surface is denoted by ●, (b) in a solution, solute particles have been denoted by ● and they also occupy part of the surface area.

In a pure liquid the entire surface is occupied by the molecules of the liquid. If a non-volatile solute is added to a solvent to give a solution [Fig. 2.4.(b)], the vapour pressure of the solution is solely from the solvent alone. This vapour pressure of the solution at a given temperature is found to be lower than the vapour pressure of the pure solvent at the same temperature. In the solution, the surface has both solute and solvent molecules; thereby the fraction of the surface covered by the solvent molecules gets reduced. Consequently, the number of solvent molecules escaping from the surface is correspondingly reduced, thus, the vapour pressure is also reduced.

The decrease in the vapour pressure of solvent depends on the quantity of non-volatile solute present in the solution, irrespective of its nature. For example, decrease in the vapour pressure of water by adding 1.0 mol of sucrose to one kg of water is nearly similar to that produced by adding 1.0 mol of urea to the same quantity of water at the same temperature.

Raoult's law in its general form can be stated as, **for any solution the partial vapour pressure of each volatile component in the solution is directly proportional to its mole fraction.**

In a binary solution, let us denote the solvent by 1 and solute by 2. When the solute is non-volatile, only the solvent molecules are present in vapour phase and contribute to vapour pressure. Let p_1 be

Fig. 2.5
If a solution obeys Raoult's law for all concentrations, its vapour pressure would vary linearly from zero to the vapour pressure of the pure solvent.

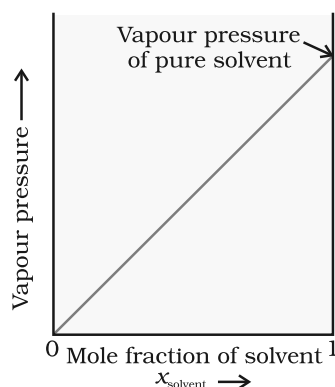

the vapour pressure of the solvent, x_1 be its mole fraction, p_1^0 be its vapour pressure in the pure state. Then according to Raoult's law

$$p_1 \propto x_1$$

$$\text{and } p_1 = x_1 p_1^0 \quad (2.20)$$

The proportionality constant is equal to the vapour pressure of pure solvent, p_1^0 . A plot between the vapour pressure and the mole fraction of the solvent is linear (Fig. 2.5).

2.5 Ideal and Non-ideal Solutions

Liquid-liquid solutions can be classified into ideal and non-ideal solutions on the basis of Raoult's law.

2.5.1 Ideal Solutions

The solutions which obey Raoult's law over the entire range of concentration are known as *ideal solutions*. The ideal solutions have two other important properties. The enthalpy of mixing of the pure components to form the solution is zero and the volume of mixing is also zero, i.e.,

$$\Delta_{\text{mix}}H = 0, \quad \Delta_{\text{mix}}V = 0 \quad (2.21)$$

It means that no heat is absorbed or evolved when the components are mixed. Also, the volume of solution would be equal to the sum of volumes of the two components. At molecular level, ideal behaviour of the solutions can be explained by considering two components A and B. In pure components, the intermolecular attractive interactions will be of types A-A and B-B, whereas in the binary solutions in addition to these two interactions, A-B type of interactions will also be present. If the intermolecular attractive forces between the A-A and B-B are nearly equal to those between A-B, this leads to the formation of ideal solution. A perfectly ideal solution is rare but some solutions are nearly ideal in behaviour. Solution of n-hexane and n-heptane, bromoethane and chloroethane, benzene and toluene, etc. fall into this category.

2.5.2 Non-ideal Solutions

When a solution does not obey Raoult's law over the entire range of concentration, then it is called *non-ideal solution*. The vapour pressure of such a solution is either higher or lower than that predicted by Raoult's law (equation 2.16). If it is higher, the solution exhibits **positive deviation** and if it is lower, it exhibits **negative deviation** from Raoult's law. The plots of vapour pressure as a function of mole fractions for such solutions are shown in Fig. 2.6.

The cause for these deviations lie in the nature of interactions at the molecular level. In case of positive deviation from Raoult's law, A-B interactions are weaker than those between A-A or B-B, i.e., in this case the intermolecular attractive forces between the solute-solvent molecules are weaker than those between the solute-solute and solvent-solvent molecules. This means that in such solutions, molecules of A (or B) will find it easier to escape than in pure state. This will increase the vapour

Fig.2.6
The vapour pressures of two component systems as a function of composition (a) a solution that shows positive deviation from Raoult's law and (b) a solution that shows negative deviation from Raoult's law.

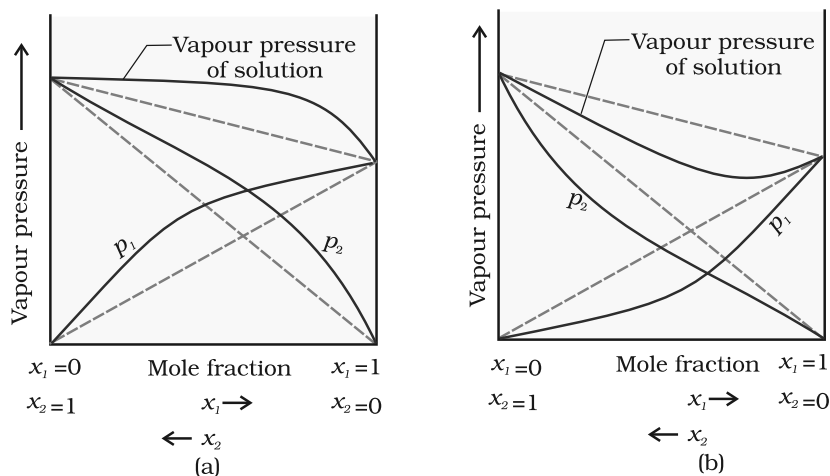

pressure and result in positive deviation. Mixtures of ethanol and acetone behave in this manner. In pure ethanol, molecules are hydrogen bonded. On adding acetone, its molecules get in between the host molecules and break some of the hydrogen bonds between them. Due to weakening of interactions, the solution shows positive deviation from Raoult's law [Fig. 2.6 (a)]. In a solution formed by adding carbon disulphide to acetone, the dipolar interactions between solute-solvent molecules are weaker than the respective interactions among the solute-solute and solvent-solvent molecules. This solution also shows positive deviation.

In case of negative deviations from Raoult's law, the intermolecular attractive forces between A-A and B-B are weaker than those between A-B and leads to decrease in vapour pressure resulting in negative deviations. An example of this type is a mixture of phenol and aniline. In this case the intermolecular hydrogen bonding between phenolic proton and lone pair on nitrogen atom of aniline is stronger than the respective intermolecular hydrogen bonding between similar molecules. Similarly, a mixture of chloroform and acetone forms a solution with negative deviation from Raoult's law. This is because chloroform molecule is able to form hydrogen bond with acetone molecule as shown.

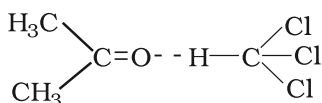

This decreases the escaping tendency of molecules for each component and consequently the vapour pressure decreases resulting in negative deviation from Raoult's law [Fig. 2.6. (b)].

Some liquids on mixing, form **azeotropes** which are binary mixtures having the same composition in liquid and vapour phase and boil at a constant temperature. In such cases, it is not possible to separate the components by fractional distillation. There are two types of azeotropes called **minimum boiling azeotrope** and **maximum boiling azeotrope**. The solutions which show a large positive deviation from Raoult's law form minimum boiling azeotrope at a specific composition.

For example, ethanol-water mixture (obtained by fermentation of sugars) on fractional distillation gives a solution containing approximately 95% by volume of ethanol. Once this composition, known as azeotrope composition, has been achieved, the liquid and vapour have the same composition, and no further separation occurs.

The solutions that show large negative deviation from Raoult's law form maximum boiling azeotrope at a specific composition. Nitric acid and water is an example of this class of azeotrope. This azeotrope has the approximate composition, 68% nitric acid and 32% water by mass, with a boiling point of 393.5 K.

Intext Question

2.8 The vapour pressure of pure liquids A and B are 450 and 700 mm Hg respectively, at 350 K. Find out the composition of the liquid mixture if total vapour pressure is 600 mm Hg. Also find the composition of the vapour phase.

2.6 Colligative Properties and Determination of Molar Mass

We have learnt in Section 2.4.3 that the vapour pressure of solution decreases when a non-volatile solute is added to a volatile solvent. There are many properties of solutions which are connected with this decrease of vapour pressure. These are: (1) relative lowering of vapour pressure of the solvent (2) depression of freezing point of the solvent (3) elevation of boiling point of the solvent and (4) osmotic pressure of the solution. **All these properties depend on the number of solute particles irrespective of their nature relative to the total number of particles present in the solution. Such properties are called colligative properties** (colligative: from Latin: co means together, ligare means to bind). In the following Sections we will discuss these properties one by one.

2.6.1 Relative Lowering of Vapour Pressure

We have learnt in Section 2.4.3 that the vapour pressure of a solvent in solution is less than that of the pure solvent. Raoult established that the lowering of vapour pressure depends only on the concentration of the solute particles and it is independent of their identity. The equation (2.20) given in Section 2.4.3 establishes a relation between vapour pressure of the solution, mole fraction and vapour pressure of the solvent, i.e.,

$$p_1 = x_1 p_1^0 \quad (2.22)$$

The reduction in the vapour pressure of solvent (Δp_1) is given as:

$$\begin{aligned} \Delta p_1 &= p_1^0 - p_1 = p_1^0 - p_1^0 x_1 \\ &= p_1^0 (1 - x_1) \end{aligned} \quad (2.23)$$

Knowing that $x_2 = 1 - x_1$, equation (2.23) reduces to

$$\Delta p_1 = x_2 p_1^0 \quad (2.24)$$

In a solution containing several non-volatile solutes, the lowering of the vapour pressure depends on the sum of the mole fraction of different solutes.

Equation (2.24) can be written as

$$\frac{\Delta p_1}{p_1^0} = \frac{p_1^0 - p_1}{p_1^0} = x_2 \quad (2.25)$$

The expression on the left hand side of the equation as mentioned earlier is called **relative lowering of vapour pressure and is equal to the mole fraction of the solute**. The above equation can be written as:

$$\frac{p_1^0 - p_1}{p_1^0} = \frac{n_2}{n_1 + n_2} \left(\text{since } x_2 = \frac{n_2}{n_1 + n_2} \right) \quad (2.26)$$

Here n_1 and n_2 are the number of moles of solvent and solute respectively present in the solution. For dilute solutions $n_2 \ll n_1$, hence neglecting n_2 in the denominator we have

$$\frac{p_1^0 - p_1}{p_1^0} = \frac{n_2}{n_1} \quad (2.27)$$

$$\text{or } \frac{p_1^0 - p_1}{p_1^0} = \frac{w_2 \times M_1}{M_2 \times w_1} \quad (2.28)$$

Here w_1 and w_2 are the masses and M_1 and M_2 are the molar masses of the solvent and solute respectively.

From this equation (2.28), knowing all other quantities, the molar mass of solute (M_2) can be calculated.

Example 2.6 The vapour pressure of pure benzene at a certain temperature is 0.850 bar. A non-volatile, non-electrolyte solid weighing 0.5 g when added to 39.0 g of benzene (molar mass 78 g mol^{-1}). Vapour pressure of the solution, then, is 0.845 bar. What is the molar mass of the solid substance?

Solution The various quantities known to us are as follows:
 $p_1^0 = 0.850 \text{ bar}$; $p = 0.845 \text{ bar}$; $M_1 = 78 \text{ g mol}^{-1}$; $w_2 = 0.5 \text{ g}$; $w_1 = 39 \text{ g}$
 Substituting these values in equation (2.28), we get

$$\frac{0.850 \text{ bar} - 0.845 \text{ bar}}{0.850 \text{ bar}} = \frac{0.5 \text{ g} \times 78 \text{ g mol}^{-1}}{M_2 \times 39 \text{ g}}$$

Therefore, $M_2 = 170 \text{ g mol}^{-1}$

2.6.2 Elevation of Boiling Point

We have learnt in Unit 5, Class XI, that the vapour pressure of a liquid increases with increase of temperature. It boils at the temperature at which its vapour pressure is equal to the atmospheric pressure. For example, water boils at 373.15 K (100° C) because at this temperature the vapour pressure of water is 1.013 bar (1 atmosphere). We have also learnt in the last section that vapour pressure of the solvent decreases in the presence of non-volatile solute. Fig. 2.7 depicts the variation of vapour pressure of the pure solvent and solution as a function of temperature. For example, the vapour pressure of an aqueous solution of sucrose is less than 1.013 bar at 373.15 K . In order to make this solution boil, its vapour pressure must be increased to 1.013 bar by raising the temperature above the boiling temperature of the pure solvent (water). Thus, the boiling

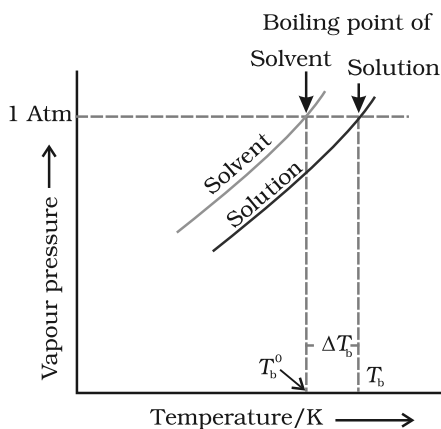

Fig. 2.7: The vapour pressure curve for solution lies below the curve for pure water. The diagram shows that ΔT_b denotes the elevation of boiling point of a solvent in solution.

point of a solution is always higher than that of the boiling point of the pure solvent in which the solution is prepared as shown in Fig. 2.7. Similar to lowering of vapour pressure, the elevation of boiling point also depends on the number of solute molecules rather than their nature. A solution of 1 mol of sucrose in 1000 g of water boils at 373.52 K at one atmospheric pressure.

Let T_b^0 be the boiling point of pure solvent and T_b be the boiling point of solution. The increase in the boiling point $\Delta T_b = T_b - T_b^0$ is known as **elevation of boiling point**.

Experiments have shown that for **dilute solutions** the elevation of boiling point (ΔT_b) is directly proportional to the molal concentration of the solute in a solution. Thus

$$\Delta T_b \propto m \quad (2.29)$$

$$\text{or } \Delta T_b = K_b m \quad (2.30)$$

Here m (molality) is the number of moles of solute dissolved in 1 kg of solvent and the constant of proportionality, K_b is called **Boiling Point Elevation Constant or Molal Elevation Constant (Ebullioscopic Constant)**. The unit of K_b is K kg mol^{-1} . Values of K_b for some common solvents are given in Table 2.3. If w_2 gram of solute of molar mass M_2 is dissolved in w_1 gram of solvent, then molality, m of the solution is given by the expression:

$$m = \frac{w_2/M_2}{w_1/1000} = \frac{1000 \times w_2}{M_2 \times w_1} \quad (2.31)$$

Substituting the value of molality in equation (2.30) we get

$$\Delta T_b = \frac{K_b \times 1000 \times w_2}{M_2 \times w_1} \quad (2.32)$$

$$M_2 = \frac{1000 \times w_2 \times K_b}{\Delta T_b \times w_1} \quad (2.33)$$

Thus, in order to determine M_2 , molar mass of the solute, known mass of solute in a known mass of the solvent is taken and ΔT_b is determined experimentally for a known solvent whose K_b value is known.

18 g of glucose, $\text{C}_6\text{H}_{12}\text{O}_6$, is dissolved in 1 kg of water in a saucepan. At what temperature will water boil at 1.013 bar? K_b for water is $0.52 \text{ K kg mol}^{-1}$.

Moles of glucose = $18 \text{ g} / 180 \text{ g mol}^{-1} = 0.1 \text{ mol}$
 Number of kilograms of solvent = 1 kg
 Thus molality of glucose solution = 0.1 mol kg^{-1}
 For water, change in boiling point

Example 2.7

Solution

$$\Delta T_b = K_b \times m = 0.52 \text{ K kg mol}^{-1} \times 0.1 \text{ mol kg}^{-1} = 0.052 \text{ K}$$

Since water boils at 373.15 K at 1.013 bar pressure, therefore, the boiling point of solution will be $373.15 + 0.052 = 373.202 \text{ K}$.

Example 2.8 The boiling point of benzene is 353.23 K. When 1.80 g of a non-volatile solute was dissolved in 90 g of benzene, the boiling point is raised to 354.11 K. Calculate the molar mass of the solute. K_b for benzene is $2.53 \text{ K kg mol}^{-1}$

Solution The elevation (ΔT_b) in the boiling point = $354.11 \text{ K} - 353.23 \text{ K} = 0.88 \text{ K}$
Substituting these values in expression (2.33) we get

$$M_2 = \frac{2.53 \text{ K kg mol}^{-1} \times 1.8 \text{ g} \times 1000 \text{ g kg}^{-1}}{0.88 \text{ K} \times 90 \text{ g}} = 58 \text{ g mol}^{-1}$$

Therefore, molar mass of the solute, $M_2 = 58 \text{ g mol}^{-1}$

2.6.3 Depression of Freezing Point

The lowering of vapour pressure of a solution causes a lowering of the freezing point compared to that of the pure solvent (Fig. 2.8). We know that at the freezing point of a substance, the solid phase is in

dynamic equilibrium with the liquid phase. Thus, the freezing point of a substance may be defined as the temperature at which the vapour pressure of the substance in its liquid phase is equal to its vapour pressure in the solid phase. A solution will freeze when its vapour pressure equals the vapour pressure of the pure solid solvent as is clear from Fig. 2.8. According to Raoult's law, when a non-volatile solid is added to the solvent its vapour pressure decreases and now it would become equal to that of solid solvent at lower temperature. Thus, the freezing point of the solvent decreases.

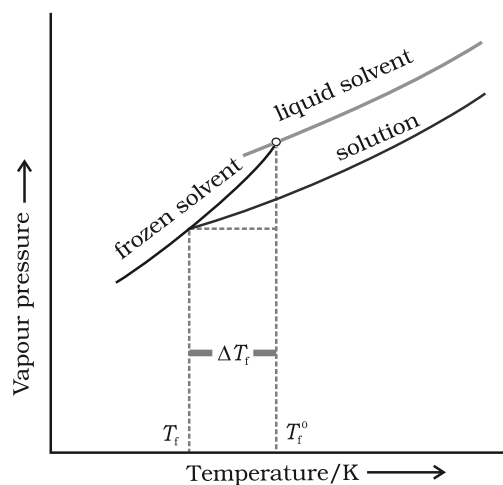

Fig. 2.8: Diagram showing ΔT_f , depression of the freezing point of a solvent in a solution.

Let T_f^0 be the freezing point of pure solvent and T_f be its freezing point when non-volatile solute is dissolved in it. The decrease in freezing point.

$\Delta T_f = T_f^0 - T_f$ is known as depression in freezing point.

Similar to elevation of boiling point, depression of freezing point (ΔT_f) for **dilute solution** (ideal solution) is directly proportional to molality, m of the solution. Thus,

$$\Delta T_f \propto m$$

$$\text{or } \Delta T_f = K_f m \quad (2.34)$$

The proportionality constant, K_f , which depends on the nature of the solvent is known as **Freezing Point Depression Constant or Molal**

Depression Constant or Cryoscopic Constant. The unit of K_f is K kg mol^{-1} . Values of K_f for some common solvents are listed in Table 2.3.

If w_2 gram of the solute having molar mass as M_2 , present in w_1 gram of solvent, produces the depression in freezing point ΔT_f of the solvent then molality of the solute is given by the equation (2.31).

$$m = \frac{w_2 / M_2}{w_1 / 1000} \quad (2.31)$$

Substituting this value of molality in equation (2.34) we get:

$$\Delta T_f = \frac{K_f \times w_2 / M_2}{w_1 / 1000}$$

$$\Delta T_f = \frac{K_f \times w_2 \times 1000}{M_2 \times w_1} \quad (2.35)$$

$$M_2 = \frac{K_f \times w_2 \times 1000}{\Delta T_f \times w_1} \quad (2.36)$$

Thus for determining the molar mass of the solute we should know the quantities w_1 , w_2 , ΔT_f , along with the molal freezing point depression constant.

The values of K_f and K_b , which depend upon the nature of the solvent, can be ascertained from the following relations.

$$K_f = \frac{R \times M_1 \times T_f^2}{1000 \times \Delta_{\text{fus}}H} \quad (2.37)$$

$$K_b = \frac{R \times M_1 \times T_b^2}{1000 \times \Delta_{\text{vap}}H} \quad (2.38)$$

Here the symbols R and M_1 stand for the gas constant and molar mass of the solvent, respectively and T_f and T_b denote the freezing point and the boiling point of the pure solvent respectively in kelvin. Further, $\Delta_{\text{fus}}H$ and $\Delta_{\text{vap}}H$ represent the enthalpies for the fusion and vapourisation of the solvent, respectively.

Table 2.3: Molal Boiling Point Elevation and Freezing Point Depression Constants for Some Solvents

Solvent	b. p./K	$K_b/\text{K kg mol}^{-1}$	f. p./K	$K_f/\text{K kg mol}^{-1}$
Water	373.15	0.52	273.0	1.86
Ethanol	351.5	1.20	155.7	1.99
Cyclohexane	353.74	2.79	279.55	20.00
Benzene	353.3	2.53	278.6	5.12
Chloroform	334.4	3.63	209.6	4.79
Carbon tetrachloride	350.0	5.03	250.5	31.8
Carbon disulphide	319.4	2.34	164.2	3.83
Diethyl ether	307.8	2.02	156.9	1.79
Acetic acid	391.1	2.93	290.0	3.90

Example 2.9 45 g of ethylene glycol ($C_2H_6O_2$) is mixed with 600 g of water. Calculate (a) the freezing point depression and (b) the freezing point of the solution.

Solution Depression in freezing point is related to the molality, therefore, the molality of the solution with respect to ethylene glycol = $\frac{\text{moles of ethylene glycol}}{\text{mass of water in kilogram}}$

$$\text{Moles of ethylene glycol} = \frac{45 \text{ g}}{62 \text{ g mol}^{-1}} = 0.73 \text{ mol}$$

$$\text{Mass of water in kg} = \frac{600 \text{ g}}{1000 \text{ g kg}^{-1}} = 0.6 \text{ kg}$$

$$\text{Hence molality of ethylene glycol} = \frac{0.73 \text{ mol}}{0.60 \text{ kg}} = 1.2 \text{ mol kg}^{-1}$$

Therefore freezing point depression,

$$\Delta T_f = 1.86 \text{ K kg mol}^{-1} \times 1.2 \text{ mol kg}^{-1} = 2.2 \text{ K}$$

$$\text{Freezing point of the aqueous solution} = 273.15 \text{ K} - 2.2 \text{ K} = 270.95 \text{ K}$$

Example 2.10 1.00 g of a non-electrolyte solute dissolved in 50 g of benzene lowered the freezing point of benzene by 0.40 K. The freezing point depression constant of benzene is $5.12 \text{ K kg mol}^{-1}$. Find the molar mass of the solute.

Solution Substituting the values of various terms involved in equation (2.36) we get,

$$M_2 = \frac{5.12 \text{ K kg mol}^{-1} \times 1.00 \text{ g} \times 1000 \text{ g kg}^{-1}}{0.40 \times 50 \text{ g}} = 256 \text{ g mol}^{-1}$$

Thus, molar mass of the solute = 256 g mol^{-1}

2.6.4 Osmosis and Osmotic Pressure

There are many phenomena which we observe in nature or at home. For example, raw mangoes shrivel when pickled in brine (salt water); wilted flowers revive when placed in fresh water, blood cells collapse when suspended in saline water, etc. If we look into these processes we

find one thing common in all, that is, all these substances are bound by membranes. These membranes can be of animal or vegetable origin and these occur naturally such as pig's bladder or parchment or can be synthetic such as cellophane. These membranes appear to be continuous sheets or films, yet they contain a network of submicroscopic holes or pores. Small solvent

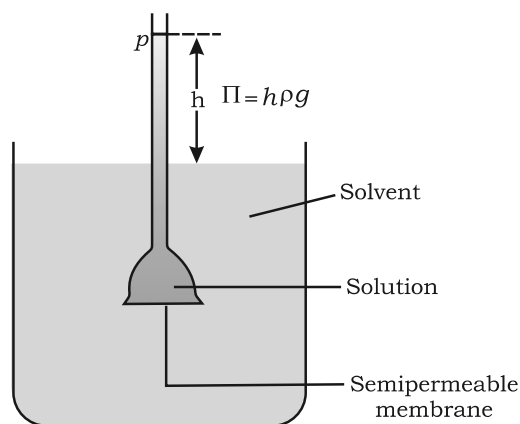

Fig. 2.9
Level of solution rises in the thistle funnel due to osmosis of solvent.

molecules, like water, can pass through these holes but the passage of bigger molecules like solute is hindered. Membranes having this kind of properties are known as *semipermeable membranes* (SPM).

Assume that only solvent molecules can pass through these semipermeable membranes. If this membrane is placed between the solvent and solution as shown in Fig. 2.9, the solvent molecules will flow through the membrane from pure solvent to the solution. **This process of flow of the solvent is called osmosis.**

The flow will continue till the equilibrium is attained. The flow of the solvent from its side to solution side across a semipermeable membrane can be stopped if some extra pressure is applied on the solution. **This pressure that just stops the flow of solvent is called osmotic pressure of the solution.** The flow of solvent from dilute solution to the concentrated solution across a semipermeable membrane is due to osmosis. The important point to be kept in mind is that solvent molecules always flow from lower concentration to higher concentration of solution. The osmotic pressure has been found to depend on the concentration of the solution.

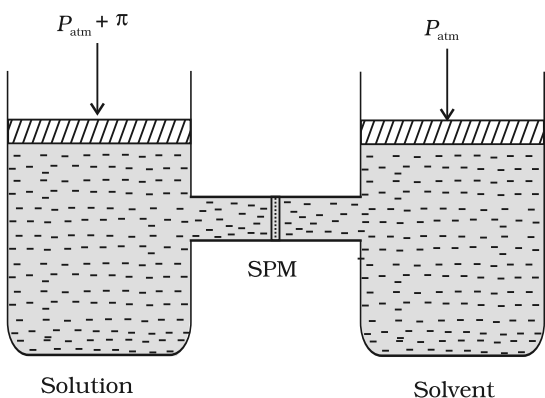

Fig. 2.10: The excess pressure equal to the osmotic pressure must be applied on the solution side to prevent osmosis.

The osmotic pressure of a solution is the excess pressure that must be applied to a solution to prevent osmosis, i.e., to stop the passage of solvent molecules through a semipermeable membrane into the solution. This is illustrated in Fig. 2.10. Osmotic pressure is a colligative property as it depends on the number of solute molecules and not on their identity. For dilute solutions, it has been found experimentally that **osmotic pressure is proportional to the molarity, C of the solution at a given temperature T.** Thus:

$$\delta = C R T \quad (2.39)$$

Here δ is the osmotic pressure and R is the gas constant.

$$\delta = (n_2 / V) R T \quad (2.40)$$

Here V is volume of a solution in litres containing n_2 moles of solute. If w_2 grams of solute, of molar mass, M_2 is present in the solution, then $n_2 = w_2 / M_2$ and we can write,

$$\delta V = \frac{w_2 R T}{M_2} \quad (2.41)$$

$$\text{or } M_2 = \frac{w_2 R T}{\pi V} \quad (2.42)$$

Thus, knowing the quantities w_2 , T, δ and V we can calculate the molar mass of the solute.

Measurement of osmotic pressure provides another method of determining molar masses of solutes. This method is widely used to determine molar masses of proteins, polymers and other

macromolecules. The osmotic pressure method has the advantage over other methods as pressure measurement is around the room temperature and the molarity of the solution is used instead of molality. As compared to other colligative properties, its magnitude is large even for very dilute solutions. The technique of osmotic pressure for determination of molar mass of solutes is particularly useful for biomolecules as they are generally not stable at higher temperatures and polymers have poor solubility.

Two solutions having same osmotic pressure at a given temperature are called isotonic solutions. When such solutions are separated by semipermeable membrane no osmosis occurs between them. For example, the osmotic pressure associated with the fluid inside the blood cell is equivalent to that of 0.9% (mass/volume) sodium chloride solution, called normal saline solution and it is safe to inject intravenously. On the other hand, if we place the cells in a solution containing more than 0.9% (mass/volume) sodium chloride, water will flow out of the cells and they would shrink. Such a solution is called **hypertonic**. If the salt concentration is less than 0.9% (mass/volume), the solution is said to be **hypotonic**. In this case, water will flow into the cells if placed in this solution and they would swell.

Example 2.11 200 cm³ of an aqueous solution of a protein contains 1.26 g of the protein. The osmotic pressure of such a solution at 300 K is found to be 2.57×10^{-3} bar. Calculate the molar mass of the protein.

Solution The various quantities known to us are as follows: $\delta = 2.57 \times 10^{-3}$ bar,

$$V = 200 \text{ cm}^3 = 0.200 \text{ litre}$$

$$T = 300 \text{ K}$$

$$R = 0.083 \text{ L bar mol}^{-1} \text{ K}^{-1}$$

Substituting these values in equation (2.42) we get

$$M_2 = \frac{1.26 \text{ g} \times 0.083 \text{ L bar K}^{-1} \text{ mol}^{-1} \times 300 \text{ K}}{2.57 \times 10^{-3} \text{ bar} \times 0.200 \text{ L}} = 61,022 \text{ g mol}^{-1}$$

The phenomena mentioned in the beginning of this section can be explained on the basis of osmosis. A raw mango placed in concentrated salt solution loses water via osmosis and shrivel into pickle. Wilted flowers revive when placed in fresh water. A carrot that has become limp because of water loss into the atmosphere can be placed into the water making it firm once again. Water will move into them through osmosis. When placed in water containing less than 0.9% (mass/volume) salt, blood cells collapse due to loss of water by osmosis. People taking a lot of salt or salty food experience water retention in tissue cells and intercellular spaces because of osmosis. The resulting

puffiness or swelling is called **edema**. Water movement from soil into plant roots and subsequently into upper portion of the plant is partly due to osmosis. The preservation of meat by salting and of fruits by adding sugar protects against bacterial action. Through the process of osmosis, a bacterium on salted meat or candid fruit loses water, shrivels and dies.

2.6.5 Reverse Osmosis and Water Purification

The direction of osmosis can be reversed if a pressure larger than the osmotic pressure is applied to the solution side. That is, now the pure solvent flows out of the solution through the semi permeable membrane. This phenomenon is called **reverse osmosis** and is of great practical utility. Reverse osmosis is used in desalination of sea water. A schematic set up for the process is shown in Fig. 2.11.

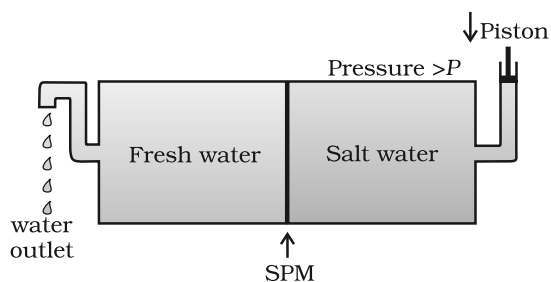

Fig. 2.11: Reverse osmosis occurs when a pressure larger than the osmotic pressure is applied to the solution.

When pressure more than osmotic pressure is applied, pure water is squeezed out of the sea water through the membrane. A variety of polymer membranes are available for this purpose.

The pressure required for the reverse osmosis is quite high. A workable porous membrane is a film of cellulose acetate placed over a suitable support. Cellulose acetate is permeable to water but impermeable to impurities and ions present in sea water. These days many countries use desalination plants to meet their potable water requirements.

Intext Questions

- 2.9** Vapour pressure of pure water at 298 K is 23.8 mm Hg. 50 g of urea (NH_2CONH_2) is dissolved in 850 g of water. Calculate the vapour pressure of water for this solution and its relative lowering.
- 2.10** Boiling point of water at 750 mm Hg is 99.63°C . How much sucrose is to be added to 500 g of water such that it boils at 100°C .
- 2.11** Calculate the mass of ascorbic acid (Vitamin C, $\text{C}_6\text{H}_8\text{O}_6$) to be dissolved in 75 g of acetic acid to lower its melting point by 1.5°C . $K_f = 3.9 \text{ K kg mol}^{-1}$.
- 2.12** Calculate the osmotic pressure in pascals exerted by a solution prepared by dissolving 1.0 g of polymer of molar mass 185,000 in 450 mL of water at 37°C .

2.7 Abnormal Molar Masses

We know that ionic compounds when dissolved in water dissociate into cations and anions. For example, if we dissolve one mole of KCl (74.5 g) in water, we expect one mole each of K^+ and Cl^- ions to be released in the solution. If this happens, there would be two moles of particles in the solution. If we ignore interionic attractions, one mole of KCl in one kg of water would be expected to increase the boiling point by $2 \times 0.52 \text{ K} = 1.04 \text{ K}$. Now if we did not know about the degree of

dissociation, we could be led to conclude that the mass of 2 mol particles is 74.5 g and the mass of one mole of KCl would be 37.25 g. This brings into light the rule that, when there is dissociation of solute into ions, the experimentally determined molar mass is always lower than the true value.

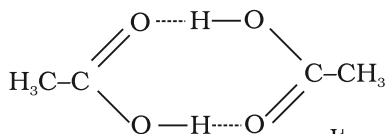
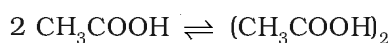

Molecules of ethanoic acid (acetic acid) dimerise in benzene due to hydrogen bonding. This normally happens in solvents of low dielectric constant. In this case the number of particles is reduced due to dimerisation. Association of molecules is depicted as follows:

It can be undoubtedly stated here that if all the molecules of ethanoic acid associate in benzene, then ΔT_b or ΔT_f for ethanoic acid will be half of the normal value. The molar mass calculated on the basis of this ΔT_b or ΔT_f will, therefore, be twice the expected value. Such a molar mass that is either lower or higher than the expected or normal value is called as **abnormal molar mass**.

In 1880 van't Hoff introduced a factor i , known as the van't Hoff factor, to account for the extent of dissociation or association. This factor i is defined as:

$$i = \frac{\text{Normal molar mass}}{\text{Abnormal molar mass}}$$

$$= \frac{\text{Observed colligative property}}{\text{Calculated colligative property}}$$

$$i = \frac{\text{Total number of moles of particles after association/dissociation}}{\text{Number of moles of particles before association/dissociation}}$$

Here abnormal molar mass is the experimentally determined molar mass and calculated colligative properties are obtained by assuming that the non-volatile solute is neither associated nor dissociated. In case of association, value of i is less than unity while for dissociation it is greater than unity. For example, the value of i for aqueous KCl solution is close to 2, while the value for ethanoic acid in benzene is nearly 0.5.

Inclusion of van't Hoff factor modifies the equations for colligative properties as follows:

Relative lowering of vapour pressure of solvent,

$$\frac{p_1^0 - p_1}{p_1^0} = i \cdot \frac{n_2}{n_1}$$

$$\text{Elevation of Boiling point, } \Delta T_b = i K_b m$$

$$\text{Depression of Freezing point, } \Delta T_f = i K_f m$$

$$\text{Osmotic pressure of solution, } \delta = i n_2 R T / V$$

Table 2.4 depicts values of the factor, i for several strong electrolytes. For KCl, NaCl and MgSO_4 , i approach 2 as the solution becomes very dilute. As expected, the value of i gets close to 3 for K_2SO_4 .

Table 2.4: Values of Van't Hoff factor, i , at Various Concentrations for NaCl, KCl, MgSO_4 and K_2SO_4 .

Salt	*Values of i			van't Hoff Factor i for complete dissociation of solute
	0.1 m	0.01 m	0.001 m	
NaCl	1.87	1.94	1.97	2.00
KCl	1.85	1.94	1.98	2.00
MgSO_4	1.21	1.53	1.82	2.00
K_2SO_4	2.32	2.70	2.84	3.00

* represent i values for incomplete dissociation.

2 g of benzoic acid ($\text{C}_6\text{H}_5\text{COOH}$) dissolved in 25 g of benzene shows a depression in freezing point equal to 1.62 K. Molal depression constant for benzene is $4.9 \text{ K kg mol}^{-1}$. What is the percentage association of acid if it forms dimer in solution? *Example 2.12*

The given quantities are: $w_2 = 2 \text{ g}$; $K_f = 4.9 \text{ K kg mol}^{-1}$; $w_1 = 25 \text{ g}$,
 $\Delta T_f = 1.62 \text{ K}$

Substituting these values in equation (2.36) we get:

$$M_2 = \frac{4.9 \text{ K kg mol}^{-1} \times 2 \text{ g} \times 1000 \text{ g kg}^{-1}}{25 \text{ g} \times 1.62 \text{ K}} = 241.98 \text{ g mol}^{-1}$$

Thus, experimental molar mass of benzoic acid in benzene is
 $= 241.98 \text{ g mol}^{-1}$

Now consider the following equilibrium for the acid:

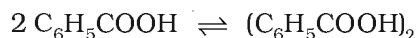

If x represents the degree of association of the solute then we would have $(1 - x)$ mol of benzoic acid left in unassociated form and correspondingly $\frac{x}{2}$ as associated moles of benzoic acid at equilibrium.

Therefore, total number of moles of particles at equilibrium is:

$$1 - x + \frac{x}{2} = 1 - \frac{x}{2}$$

Thus, total number of moles of particles at equilibrium equals van't Hoff factor i .

$$\text{But } i = \frac{\text{Normal molar mass}}{\text{Abnormal molar mass}}$$

Solution

$$= \frac{122 \text{ g mol}^{-1}}{241.98 \text{ g mol}^{-1}}$$

$$\text{or } \frac{x}{2} = 1 - \frac{122}{241.98} = 1 - 0.504 = 0.496$$

$$\text{or } x = 2 \times 0.496 = 0.992$$

Therefore, degree of association of benzoic acid in benzene is 99.2 %.

Example 2.13

0.6 mL of acetic acid (CH_3COOH), having density 1.06 g mL^{-1} , is dissolved in 1 litre of water. The depression in freezing point observed for this strength of acid was 0.0205°C . Calculate the van't Hoff factor and the dissociation constant of acid.

Solution Number of moles of acetic acid $= \frac{0.6 \text{ mL} \times 1.06 \text{ g mL}^{-1}}{60 \text{ g mol}^{-1}}$
 $= 0.0106 \text{ mol} = n$

$$\text{Molality} = \frac{0.0106 \text{ mol}}{1000 \text{ mL} \times 1 \text{ g mL}^{-1}} = 0.0106 \text{ mol kg}^{-1}$$

Using equation (2.35)

$$\Delta T_f = 1.86 \text{ K kg mol}^{-1} \times 0.0106 \text{ mol kg}^{-1} = 0.0197 \text{ K}$$

$$\text{van't Hoff Factor } (i) = \frac{\text{Observed freezing point}}{\text{Calculated freezing point}} = \frac{0.0205 \text{ K}}{0.0197 \text{ K}} = 1.041$$

Acetic acid is a weak electrolyte and will dissociate into two ions: acetate and hydrogen ions per molecule of acetic acid. If x is the degree of dissociation of acetic acid, then we would have $n(1-x)$ moles of undissociated acetic acid, nx moles of CH_3COO^- and nx moles of H^+ ions,

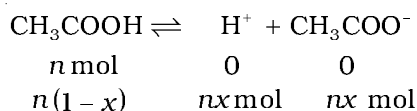

Thus total moles of particles are: $n(1-x+x+x) = n(1+x)$

$$i = \frac{n(1+x)}{n} = 1+x = 1.041$$

Thus degree of dissociation of acetic acid $= x = 1.041 - 1.000 = 0.041$

Then $[\text{CH}_3\text{COOH}] = n(1-x) = 0.0106(1-0.041)$,

$$[\text{CH}_3\text{COO}^-] = nx = 0.0106 \times 0.041, [\text{H}^+] = nx = 0.0106 \times 0.041.$$

$$\begin{aligned} K_a &= \frac{[\text{CH}_3\text{COO}^-][\text{H}^+]}{[\text{CH}_3\text{COOH}]} = \frac{0.0106 \times 0.041 \times 0.0106 \times 0.041}{0.0106(1.00 - 0.041)} \\ &= 1.86 \times 10^{-5} \end{aligned}$$

Summary

A solution is a homogeneous mixture of two or more substances. Solutions are classified as solid, liquid and gaseous solutions. The concentration of a solution is expressed in terms of mole fraction, molarity, molality and in percentages. The dissolution of a gas in a liquid is governed by **Henry's law**, according to which, at a given temperature, the **solubility of a gas in a liquid is directly proportional to the partial pressure of the gas**. The vapour pressure of the solvent is lowered by the presence of a non-volatile solute in the solution and this lowering of vapour pressure of the solvent is governed by Raoult's law, according to which the **relative lowering of vapour pressure of the solvent over a solution is equal to the mole fraction of a non-volatile solute present in the solution**. However, in a binary liquid solution, if both the components of the solution are volatile then another form of Raoult's law is used. Mathematically, this form of the Raoult's law is stated as: $p_{\text{total}} = p_1^0 x_1 + p_2^0 x_2$. **Solutions which obey Raoult's law over the entire range of concentration are called ideal solutions**. Two types of deviations from Raoult's law, called positive and negative deviations are observed. Azeotropes arise due to very large deviations from Raoult's law.

The properties of solutions which depend on the number of solute particles and are independent of their chemical identity are called colligative properties. These are lowering of vapour pressure, elevation of boiling point, depression of freezing point and osmotic pressure. The process of osmosis can be reversed if a pressure higher than the osmotic pressure is applied to the solution. Colligative properties have been used to determine the molar mass of solutes. Solutes which dissociate in solution exhibit molar mass lower than the actual molar mass and those which associate show higher molar mass than their actual values.

Quantitatively, the extent to which a solute is dissociated or associated can be expressed by van't Hoff factor i . This factor has been defined as ratio of normal molar mass to experimentally determined molar mass or as the ratio of observed colligative property to the calculated colligative property.

Exercises

- 2.1 Define the term solution. How many types of solutions are formed? Write briefly about each type with an example.
- 2.2 Suppose a solid solution is formed between two substances, one whose particles are very large and the other whose particles are very small. What kind of solid solution is this likely to be?
- 2.3 Define the following terms:
(i) Mole fraction (ii) Molality (iii) Molarity (iv) Mass percentage.
- 2.4 Concentrated nitric acid used in laboratory work is 68% nitric acid by mass in aqueous solution. What should be the molarity of such a sample of the acid if the density of the solution is 1.504 g mL^{-1} ?

- 2.5 A solution of glucose in water is labelled as 10% w/w, what would be the molality and mole fraction of each component in the solution? If the density of solution is 1.2 g mL^{-1} , then what shall be the molarity of the solution?
- 2.6 How many mL of 0.1 M HCl are required to react completely with 1 g mixture of Na_2CO_3 and NaHCO_3 containing equimolar amounts of both?
- 2.7 A solution is obtained by mixing 300 g of 25% solution and 400 g of 40% solution by mass. Calculate the mass percentage of the resulting solution.
- 2.8 An antifreeze solution is prepared from 222.6 g of ethylene glycol ($\text{C}_2\text{H}_6\text{O}_2$) and 200 g of water. Calculate the molality of the solution. If the density of the solution is 1.072 g mL^{-1} , then what shall be the molarity of the solution?
- 2.9 A sample of drinking water was found to be severely contaminated with chloroform (CHCl_3) supposed to be a carcinogen. The level of contamination was 15 ppm (by mass):
- express this in percent by mass
 - determine the molality of chloroform in the water sample.
- 2.10 What role does the molecular interaction play in a solution of alcohol and water?
- 2.11 Why do gases always tend to be less soluble in liquids as the temperature is raised?
- 2.12 State Henry's law and mention some important applications?
- 2.13 The partial pressure of ethane over a solution containing $6.56 \times 10^{-3} \text{ g}$ of ethane is 1 bar. If the solution contains $5.00 \times 10^{-2} \text{ g}$ of ethane, then what shall be the partial pressure of the gas?
- 2.14 What is meant by positive and negative deviations from Raoult's law and how is the sign of $\Delta_{\text{mix}}H$ related to positive and negative deviations from Raoult's law?
- 2.15 An aqueous solution of 2% non-volatile solute exerts a pressure of 1.004 bar at the normal boiling point of the solvent. What is the molar mass of the solute?
- 2.16 Heptane and octane form an ideal solution. At 373 K, the vapour pressures of the two liquid components are 105.2 kPa and 46.8 kPa respectively. What will be the vapour pressure of a mixture of 26.0 g of heptane and 35 g of octane?
- 2.17 The vapour pressure of water is 12.3 kPa at 300 K. Calculate vapour pressure of 1 molal solution of a non-volatile solute in it.
- 2.18 Calculate the mass of a non-volatile solute (molar mass 40 g mol^{-1}) which should be dissolved in 114 g octane to reduce its vapour pressure to 80%.
- 2.19 A solution containing 30 g of non-volatile solute exactly in 90 g of water has a vapour pressure of 2.8 kPa at 298 K. Further, 18 g of water is then added to the solution and the new vapour pressure becomes 2.9 kPa at 298 K. Calculate:
- molar mass of the solute
 - vapour pressure of water at 298 K.
- 2.20 A 5% solution (by mass) of cane sugar in water has freezing point of 271K. Calculate the freezing point of 5% glucose in water if freezing point of pure water is 273.15 K.
- 2.21 Two elements A and B form compounds having formula AB_2 and AB_4 . When dissolved in 20 g of benzene (C_6H_6), 1 g of AB_2 lowers the freezing point by 2.3 K whereas 1.0 g of AB_4 lowers it by 1.3 K. The molar depression constant for benzene is $5.1 \text{ K kg mol}^{-1}$. Calculate atomic masses of A and B.

- 2.22** At 300 K, 36 g of glucose present in a litre of its solution has an osmotic pressure of 4.98 bar. If the osmotic pressure of the solution is 1.52 bars at the same temperature, what would be its concentration?
- 2.23** Suggest the most important type of intermolecular attractive interaction in the following pairs.
- n-hexane and n-octane
 - I₂ and CCl₄
 - NaClO₄ and water
 - methanol and acetone
 - acetonitrile (CH₃CN) and acetone (C₃H₆O).
- 2.24** Based on solute-solvent interactions, arrange the following in order of increasing solubility in n-octane and explain. Cyclohexane, KCl, CH₃OH, CH₃CN.
- 2.25** Amongst the following compounds, identify which are insoluble, partially soluble and highly soluble in water?
- | | | |
|----------------------|----------------|-------------------|
| (i) phenol | (ii) toluene | (iii) formic acid |
| (iv) ethylene glycol | (v) chloroform | (vi) pentanol. |
- 2.26** If the density of some lake water is 1.25g mL⁻¹ and contains 92 g of Na⁺ ions per kg of water, calculate the molality of Na⁺ ions in the lake.
- 2.27** If the solubility product of CuS is 6×10^{-16} , calculate the maximum molarity of CuS in aqueous solution.
- 2.28** Calculate the mass percentage of aspirin (C₉H₈O₄) in acetonitrile (CH₃CN) when 6.5 g of C₉H₈O₄ is dissolved in 450 g of CH₃CN.
- 2.29** Nalorphene (C₁₉H₂₁NO₃), similar to morphine, is used to combat withdrawal symptoms in narcotic users. Dose of nalorphene generally given is 1.5 mg. Calculate the mass of 1.5 × 10⁻³ m aqueous solution required for the above dose.
- 2.30** Calculate the amount of benzoic acid (C₆H₅COOH) required for preparing 250 mL of 0.15 M solution in methanol.
- 2.31** The depression in freezing point of water observed for the same amount of acetic acid, trichloroacetic acid and trifluoroacetic acid increases in the order given above. Explain briefly.
- 2.32** Calculate the depression in the freezing point of water when 10 g of CH₃CH₂CHClCOOH is added to 250 g of water. $K_a = 1.4 \times 10^{-3}$, $K_f = 1.86$ K kg mol⁻¹.
- 2.33** 19.5 g of CH₂FCOOH is dissolved in 500 g of water. The depression in the freezing point of water observed is 1.0^o C. Calculate the van't Hoff factor and dissociation constant of fluoroacetic acid.
- 2.34** Vapour pressure of water at 293 K is 17.535 mm Hg. Calculate the vapour pressure of water at 293 K when 25 g of glucose is dissolved in 450 g of water.
- 2.35** Henry's law constant for the molality of methane in benzene at 298 K is 4.27 × 10⁵ mm Hg. Calculate the solubility of methane in benzene at 298 K under 760 mm Hg.
- 2.36** 100 g of liquid A (molar mass 140 g mol⁻¹) was dissolved in 1000 g of liquid B (molar mass 180 g mol⁻¹). The vapour pressure of pure liquid B was found to be 500 torr. Calculate the vapour pressure of pure liquid A and its vapour pressure in the solution if the total vapour pressure of the solution is 475 Torr.

- 2.37** Vapour pressures of pure acetone and chloroform at 328 K are 741.8 mm Hg and 632.8 mm Hg respectively. Assuming that they form ideal solution over the entire range of composition, plot p_{total} , $p_{\text{chloroform}}$, and p_{acetone} as a function of x_{acetone} . The experimental data observed for different compositions of mixture is:

$100 \times x_{\text{acetone}}$	0	11.8	23.4	36.0	50.8	58.2	64.5	72.1
$p_{\text{acetone}} / \text{mm Hg}$	0	54.9	110.1	202.4	322.7	405.9	454.1	521.1
$p_{\text{chloroform}} / \text{mm Hg}$	632.8	548.1	469.4	359.7	257.7	193.6	161.2	120.7

Plot this data also on the same graph paper. Indicate whether it has positive deviation or negative deviation from the ideal solution.

- 2.38** Benzene and toluene form ideal solution over the entire range of composition. The vapour pressure of pure benzene and naphthalene at 300 K are 50.71 mm Hg and 32.06 mm Hg respectively. Calculate the mole fraction of benzene in vapour phase if 80 g of benzene is mixed with 100 g of naphthalene.
- 2.39** The air is a mixture of a number of gases. The major components are oxygen and nitrogen with approximate proportion of 20% is to 79% by volume at 298 K. The water is in equilibrium with air at a pressure of 10 atm. At 298 K if the Henry's law constants for oxygen and nitrogen at 298 K are 3.30×10^7 mm and 6.51×10^7 mm respectively, calculate the composition of these gases in water.
- 2.40** Determine the amount of CaCl_2 ($i = 2.47$) dissolved in 2.5 litre of water such that its osmotic pressure is 0.75 atm at 27° C.
- 2.41** Determine the osmotic pressure of a solution prepared by dissolving 25 mg of K_2SO_4 in 2 litre of water at 25° C, assuming that it is completely dissociated.

Answers to Some Intext Questions

- 2.1** $\text{C}_6\text{H}_6 = 15.28\%$, $\text{CCl}_4 = 84.72\%$
- 2.2** 0.459, 0.541
- 2.3** 0.024 M, 0.03 M
- 2.4** 37.5 g
- 2.5** 1.5 mol kg^{-1} , 1.45 mol L^{-1} 0.0263
- 2.9** 289.5 bar
- 2.10** 1.86 g
- 2.11** $x_A = 0.4$, $y_A = 0.3$; $x_B = 0.6$, $y_B = 0.7$
- 2.12** 23.4 mm Hg, 0.017

Unit

3

Electrochemistry

Objectives

After studying this Unit, you will be able to

- describe an electrochemical cell and differentiate between galvanic and electrolytic cells;
- apply Nernst equation for calculating the emf of galvanic cell and define standard potential of the cell;
- derive relation between standard potential of the cell, Gibbs energy of cell reaction and its equilibrium constant;
- define resistivity (ρ), conductivity (κ) and molar conductivity (Λ_m) of ionic solutions;
- differentiate between ionic (electrolytic) and electronic conductivity;
- describe the method for measurement of conductivity of electrolytic solutions and calculation of their molar conductivity;
- justify the variation of conductivity and molar conductivity of solutions with change in their concentration and define Λ_m° (molar conductivity at zero concentration or infinite dilution);
- enunciate Kohlrausch law and learn its applications;
- understand quantitative aspects of electrolysis;
- describe the construction of some primary and secondary batteries and fuel cells;
- explain corrosion as an electrochemical process.

Chemical reactions can be used to produce electrical energy, conversely, electrical energy can be used to carry out chemical reactions that do not proceed spontaneously.

Electrochemistry is the study of production of electricity from energy released during spontaneous chemical reactions and the use of electrical energy to bring about non-spontaneous chemical transformations. The subject is of importance both for theoretical and practical considerations. A large number of metals, sodium hydroxide, chlorine, fluorine and many other chemicals are produced by electrochemical methods. Batteries and fuel cells convert chemical energy into electrical energy and are used on a large scale in various instruments and devices. The reactions carried out electrochemically can be energy efficient and less polluting. Therefore, study of electrochemistry is important for creating new technologies that are ecofriendly. The transmission of sensory signals through cells to brain and vice versa and communication between the cells are known to have electrochemical origin. Electrochemistry, is therefore, a very vast and interdisciplinary subject. In this Unit, we will cover only some of its important elementary aspects.

3.1 Electrochemical Cells

In Class XI, Unit 8, we had studied the construction and functioning of **Daniell cell** (Fig. 3.1). This cell converts the chemical energy liberated during the redox reaction

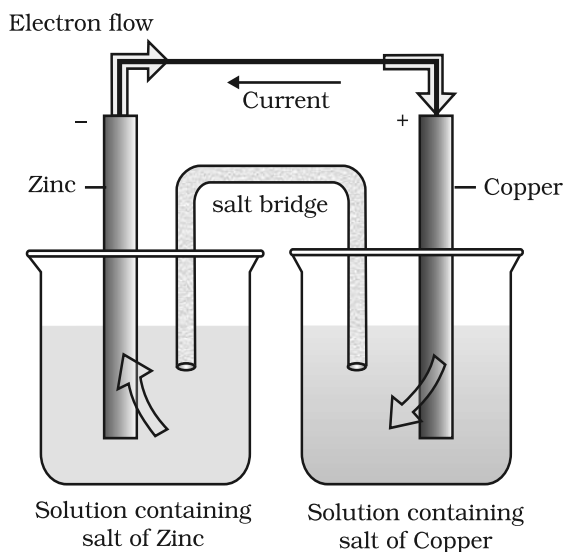
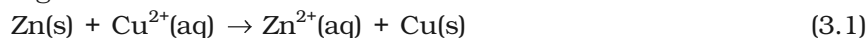
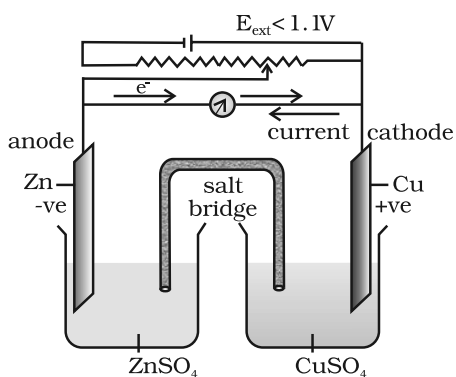

Fig. 3.1: Daniell cell having electrodes of zinc and copper dipping in the solutions of their respective salts.

to electrical energy and has an electrical potential equal to 1.1 V when concentration of Zn^{2+} and Cu^{2+} ions is unity (1 mol dm^{-3})*. Such a device is called a **galvanic** or a **voltaic** cell.

If an external opposite potential is applied [Fig. 3.2(a)] and increased slowly, we find that the reaction continues to take place till the opposing voltage reaches the value 1.1 V [Fig. 3.2(b)] when, the reaction stops altogether and no current flows through the cell. Any further increase in the external potential again starts the reaction but in the opposite direction [Fig. 3.2(c)]. It now functions as an **electrolytic cell**, a device for using electrical energy to carry non-spontaneous chemical reactions. Both types of cells are quite important and we shall study some of their salient features in the following pages.



When $E_{\text{ext}} < 1.1 \text{ V}$

- (i) Electrons flow from Zn rod to Cu rod hence current flows from Cu to Zn.
- (ii) Zn dissolves at anode and copper deposits at cathode.

(a)

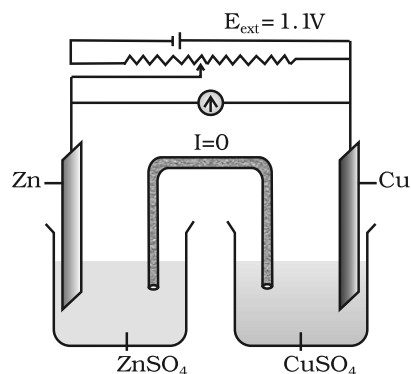

When $E_{\text{ext}} = 1.1 \text{ V}$

- (i) No flow of electrons or current.
- (ii) No chemical reaction.

(b)

*Strictly speaking activity should be used instead of concentration. It is directly proportional to concentration. In dilute solutions, it is equal to concentration. You will study more about it in higher classes.

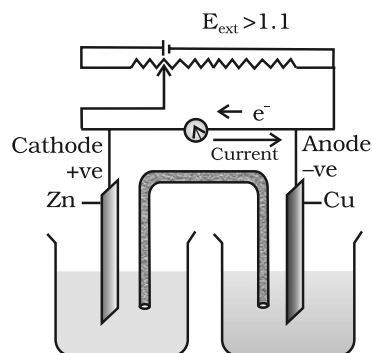

When $E_{\text{ext}} > 1.1\text{V}$

- (i) Electrons flow from Cu to Zn and current flows from Zn to Cu.
- (ii) Zinc is deposited at the zinc electrode and copper dissolves at copper electrode.

(c)

Fig. 3.2: Functioning of Daniell cell when external voltage E_{ext} opposing the cell potential is applied.

As mentioned earlier (Class XI, Unit 8) a galvanic cell is an electrochemical cell that converts the chemical energy of a spontaneous redox reaction into electrical energy. In this device the Gibbs energy of the spontaneous redox reaction is converted into electrical work which may be used for running a motor or other electrical gadgets like heater, fan, geyser, etc.

Daniell cell discussed earlier is one such cell in which the following redox reaction occurs.

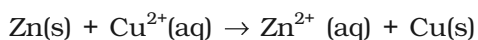

This reaction is a combination of two half reactions whose addition gives the overall cell reaction:



These reactions occur in two different portions of the Daniell cell. The reduction half reaction occurs on the copper electrode while the oxidation half reaction occurs on the zinc electrode. These two portions of the cell are also called **half-cells** or **redox couples**. The copper electrode may be called the reduction half cell and the zinc electrode, the oxidation half-cell.

We can construct innumerable number of galvanic cells on the pattern of Daniell cell by taking combinations of different half-cells. Each half-cell consists of a metallic electrode dipped into an electrolyte. The two half-cells are connected by a metallic wire through a voltmeter and a switch externally. The electrolytes of the two half-cells are connected internally through a salt bridge as shown in Fig. 3.1. Sometimes, both the electrodes dip in the same electrolyte solution and in such cases we don't require a salt bridge.

3.2 Galvanic Cells

At each electrode-electrolyte interface there is a tendency of metal ions from the solution to deposit on the metal electrode trying to make it positively charged. At the same time, metal atoms of the electrode have a tendency to go into the solution as ions and leave behind the electrons at the electrode trying to make it negatively charged. At equilibrium, there is a separation of charges and depending on the tendencies of the two opposing reactions, the electrode may be positively or negatively charged with respect to the solution. A potential difference develops between the electrode and the electrolyte which is called **electrode potential**. When the concentrations of all the species involved in a half-cell is unity then the electrode potential is known as **standard electrode potential**. According to IUPAC convention, standard reduction potentials are now called standard electrode potentials. In a galvanic cell, the half-cell in which oxidation takes place is called **anode** and it has a negative potential with respect to the solution. The other half-cell in which reduction takes place is called **cathode** and it has a positive potential with respect to the solution. Thus, there exists a potential difference between the two electrodes and as soon as the switch is in the *on* position the electrons flow from negative electrode to positive electrode. The direction of current flow is opposite to that of electron flow.

The potential difference between the two electrodes of a galvanic cell is called the *cell potential* and is measured in volts. The *cell potential* is the difference between the electrode potentials (reduction potentials) of the cathode and anode. It is called the *cell electromotive force (emf)* of the cell when no current is drawn through the cell. It is now an accepted convention that we keep the anode on the left and the cathode on the right while representing the galvanic cell. A galvanic cell is generally represented by putting a vertical line between metal and electrolyte solution and putting a double vertical line between the two electrolytes connected by a salt bridge. Under this convention the emf of the cell is positive and is given by the potential of the half-cell on the right hand side minus the potential of the half-cell on the left hand side i.e.

$$E_{\text{cell}} = E_{\text{right}} - E_{\text{left}}$$

This is illustrated by the following example:

Cell reaction:

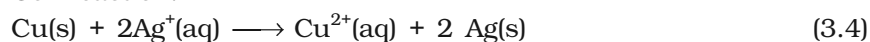

Half-cell reactions:

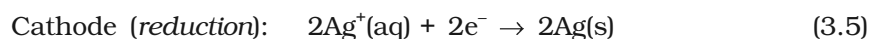

It can be seen that the sum of (3.5) and (3.6) leads to overall reaction (3.4) in the cell and that silver electrode acts as a cathode and copper electrode acts as an anode. The cell can be represented as:

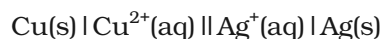

$$\text{and we have } E_{\text{cell}} = E_{\text{right}} - E_{\text{left}} = E_{\text{Ag}^+|\text{Ag}} - E_{\text{Cu}^{2+}|\text{Cu}} \quad (3.7)$$

3.2.1 Measurement of Electrode Potential

The potential of individual half-cell cannot be measured. We can measure only the difference between the two half-cell potentials that gives the emf of the cell. If we arbitrarily choose the potential of one electrode (half-

cell) then that of the other can be determined with respect to this. According to convention, a half-cell called standard hydrogen electrode (Fig.3.3) represented by $\text{Pt(s)} | \text{H}_2(\text{g}) | \text{H}^+(\text{aq})$, is assigned a zero potential at all temperatures corresponding to the reaction

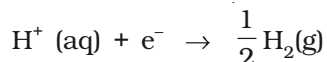

The standard hydrogen electrode consists of a platinum electrode coated with platinum black. The electrode is dipped in an acidic solution and pure hydrogen gas is bubbled through it. The concentration of both the reduced and oxidised forms of hydrogen is maintained at unity (Fig. 3.3). This implies that the pressure of hydrogen gas is one bar and the concentration of hydrogen ion in the solution is one molar.

At 298 K the emf of the cell, standard hydrogen electrode || second half-cell constructed by taking standard hydrogen electrode as anode (reference half-cell) and the other half-cell as cathode, gives the reduction potential of the other half-cell. If the concentrations of the oxidised and the reduced forms of the species in the right hand half-cell are unity, then the cell potential is equal to standard electrode potential, E_R^\ominus of the given half-cell.

$$E^\ominus = E_R^\ominus - E_L^\ominus$$

As E_L^\ominus for standard hydrogen electrode is zero.

$$E^\ominus = E_R^\ominus - 0 = E_R^\ominus$$

The measured emf of the cell :

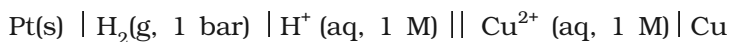

is 0.34 V and it is also the value for the standard electrode potential of the half-cell corresponding to the reaction :

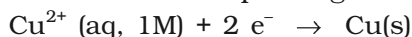

Similarly, the measured emf of the cell :

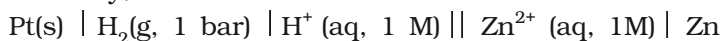

is -0.76 V corresponding to the standard electrode potential of the half-cell reaction:

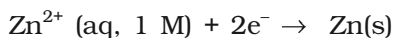

The positive value of the standard electrode potential in the first case indicates that Cu^{2+} ions get reduced more easily than H^+ ions. The reverse process cannot occur, that is, hydrogen ions cannot oxidise Cu (or alternatively we can say that hydrogen gas can reduce copper ion) under the standard conditions described above. Thus, Cu does not dissolve in HCl. In nitric acid it is oxidised by nitrate ion and not by hydrogen ion. The negative value of the standard electrode potential in the second case indicates that hydrogen ions can oxidise zinc (or zinc can reduce hydrogen ions).

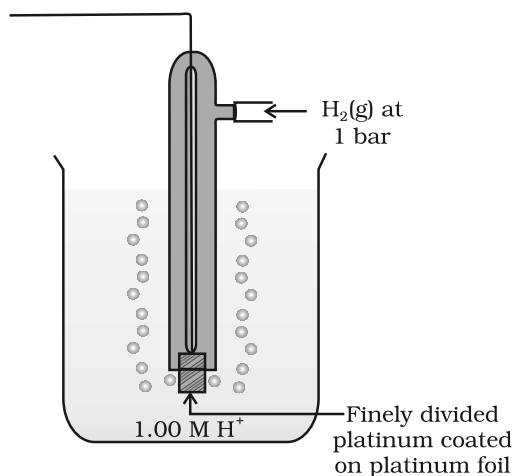
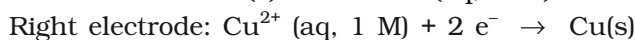
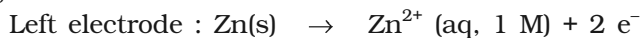
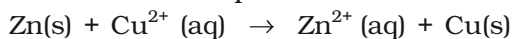

Fig. 3.3: Standard Hydrogen Electrode (SHE).

In view of this convention, the half reaction for the Daniell cell in Fig. 3.1 can be written as:



The overall reaction of the cell is the sum of above two reactions and we obtain the equation:



$$\begin{aligned} \text{Emf of the cell} &= E_{\text{cell}}^0 = E_{\text{R}}^0 - E_{\text{L}}^0 \\ &= 0.34\text{V} - (-0.76)\text{V} = 1.10 \text{ V} \end{aligned}$$

Sometimes metals like platinum or gold are used as inert electrodes. They do not participate in the reaction but provide their surface for oxidation or reduction reactions and for the conduction of electrons. For example, Pt is used in the following half-cells:

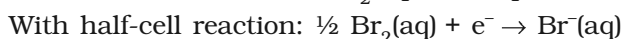
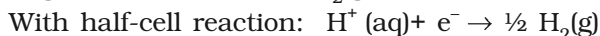
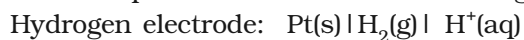

The standard electrode potentials are very important and we can extract a lot of useful information from them. The values of standard electrode potentials for some selected half-cell reduction reactions are given in Table 3.1. If the standard electrode potential of an electrode is greater than zero then its reduced form is more stable compared to hydrogen gas. Similarly, if the standard electrode potential is negative then hydrogen gas is more stable than the reduced form of the species. It can be seen that the standard electrode potential for fluorine is the highest in the Table indicating that fluorine gas (F_2) has the maximum tendency to get reduced to fluoride ions (F^-) and therefore fluorine gas is the strongest oxidising agent and fluoride ion is the weakest reducing agent. Lithium has the lowest electrode potential indicating that lithium ion is the weakest oxidising agent while lithium metal is the most powerful reducing agent in an aqueous solution. It may be seen that as we go from top to bottom in Table 3.1 the standard electrode potential decreases and with this, decreases the oxidising power of the species on the left and increases the reducing power of the species on the right hand side of the reaction. Electrochemical cells are extensively used for determining the pH of solutions, solubility product, equilibrium constant and other thermodynamic properties and for potentiometric titrations.

Intext Questions

- 3.1** How would you determine the standard electrode potential of the system $\text{Mg}^{2+} | \text{Mg}$?
- 3.2** Can you store copper sulphate solutions in a zinc pot?
- 3.3** Consult the table of standard electrode potentials and suggest three substances that can oxidise ferrous ions under suitable conditions.

Table 3.1 The standard electrode potentials at 298 K

Ions are present as aqueous species and H₂O as liquid; gases and solids are shown by g and s.

Reaction (Oxidised form + ne ⁻ → Reduced form)	E ^o /V
F ₂ (g) + 2e ⁻ → 2F ⁻	2.87
Co ³⁺ + e ⁻ → Co ²⁺	1.81
H ₂ O ₂ + 2H ⁺ + 2e ⁻ → 2H ₂ O	1.78
MnO ₄ ⁻ + 8H ⁺ + 5e ⁻ → Mn ²⁺ + 4H ₂ O	1.51
Au ³⁺ + 3e ⁻ → Au(s)	1.40
Cl ₂ (g) + 2e ⁻ → 2Cl ⁻	1.36
Cr ₂ O ₇ ²⁻ + 14H ⁺ + 6e ⁻ → 2Cr ³⁺ + 7H ₂ O	1.33
O ₂ (g) + 4H ⁺ + 4e ⁻ → 2H ₂ O	1.23
MnO ₂ (s) + 4H ⁺ + 2e ⁻ → Mn ²⁺ + 2H ₂ O	1.23
Br ₂ + 2e ⁻ → 2Br ⁻	1.09
NO ₃ ⁻ + 4H ⁺ + 3e ⁻ → NO(g) + 2H ₂ O	0.97
2Hg ²⁺ + 2e ⁻ → Hg ₂ ²⁺	0.92
Ag ⁺ + e ⁻ → Ag(s)	0.80
Fe ³⁺ + e ⁻ → Fe ²⁺	0.77
O ₂ (g) + 2H ⁺ + 2e ⁻ → H ₂ O ₂	0.68
I ₂ + 2e ⁻ → 2I ⁻	0.54
Cu ⁺ + e ⁻ → Cu(s)	0.52
Cu ²⁺ + 2e ⁻ → Cu(s)	0.34
AgCl(s) + e ⁻ → Ag(s) + Cl ⁻	0.22
AgBr(s) + e ⁻ → Ag(s) + Br ⁻	0.10
2H⁺ + 2e⁻ → H₂(g)	0.00
Pb ²⁺ + 2e ⁻ → Pb(s)	-0.13
Sn ²⁺ + 2e ⁻ → Sn(s)	-0.14
Ni ²⁺ + 2e ⁻ → Ni(s)	-0.25
Fe ²⁺ + 2e ⁻ → Fe(s)	-0.44
Cr ³⁺ + 3e ⁻ → Cr(s)	-0.74
Zn ²⁺ + 2e ⁻ → Zn(s)	-0.76
2H ₂ O + 2e ⁻ → H ₂ (g) + 2OH ⁻ (aq)	-0.83
Al ³⁺ + 3e ⁻ → Al(s)	-1.66
Mg ²⁺ + 2e ⁻ → Mg(s)	-2.36
Na ⁺ + e ⁻ → Na(s)	-2.71
Ca ²⁺ + 2e ⁻ → Ca(s)	-2.87
K ⁺ + e ⁻ → K(s)	-2.93
Li ⁺ + e ⁻ → Li(s)	-3.05

1. A negative E^o means that the redox couple is a stronger reducing agent than the H⁺/H₂ couple.
2. A positive E^o means that the redox couple is a weaker reducing agent than the H⁺/H₂ couple.

3.3 Nernst Equation

We have assumed in the previous section that the concentration of all the species involved in the electrode reaction is unity. This need not be always true. Nernst showed that for the electrode reaction:

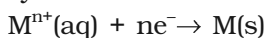

the electrode potential at any concentration measured with respect to standard hydrogen electrode can be represented by:

$$E_{(M^{n+}/M)} = E_{(M^{n+}/M)}^{\ominus} - \frac{RT}{nF} \ln \frac{[M]}{[M^{n+}]}$$

but concentration of solid M is taken as unity and we have

$$E_{(M^{n+}/M)} = E_{(M^{n+}/M)}^{\ominus} - \frac{RT}{nF} \ln \frac{1}{[M^{n+}]} \quad (3.8)$$

$E_{(M^{n+}/M)}^{\ominus}$ has already been defined, R is gas constant ($8.314 \text{ JK}^{-1} \text{ mol}^{-1}$), F is Faraday constant (96487 C mol^{-1}), T is temperature in kelvin and $[M^{n+}]$ is the concentration of the species, M^{n+} .

In Daniell cell, the electrode potential for any given concentration of Cu^{2+} and Zn^{2+} ions, we write

For Cathode:

$$E_{(\text{Cu}^{2+}/\text{Cu})} = E_{(\text{Cu}^{2+}/\text{Cu})}^{\ominus} - \frac{RT}{2F} \ln \frac{1}{[\text{Cu}^{2+}(\text{aq})]} \quad (3.9)$$

For Anode:

$$E_{(\text{Zn}^{2+}/\text{Zn})} = E_{(\text{Zn}^{2+}/\text{Zn})}^{\ominus} - \frac{RT}{2F} \ln \frac{1}{[\text{Zn}^{2+}(\text{aq})]} \quad (3.10)$$

The cell potential, $E_{(\text{cell})} = E_{(\text{Cu}^{2+}/\text{Cu})} - E_{(\text{Zn}^{2+}/\text{Zn})}$

$$= E_{(\text{Cu}^{2+}/\text{Cu})}^{\ominus} - \frac{RT}{2F} \ln \frac{1}{[\text{Cu}^{2+}(\text{aq})]} - E_{(\text{Zn}^{2+}/\text{Zn})}^{\ominus} + \frac{RT}{2F} \ln \frac{1}{[\text{Zn}^{2+}(\text{aq})]}$$

$$= E_{(\text{Cu}^{2+}/\text{Cu})}^{\ominus} - E_{(\text{Zn}^{2+}/\text{Zn})}^{\ominus} - \frac{RT}{2F} \ln \frac{1}{[\text{Cu}^{2+}(\text{aq})]} - \ln \frac{1}{[\text{Zn}^{2+}(\text{aq})]}$$

$$E_{(\text{cell})} = E_{(\text{cell})}^{\ominus} - \frac{RT}{2F} \ln \frac{[\text{Zn}^{2+}]}{[\text{Cu}^{2+}]} \quad (3.11)$$

It can be seen that $E_{(\text{cell})}$ depends on the concentration of both Cu^{2+} and Zn^{2+} ions. It increases with increase in the concentration of Cu^{2+} ions and decrease in the concentration of Zn^{2+} ions.

By converting the natural logarithm in Eq. (3.11) to the base 10 and substituting the values of R , F and $T = 298 \text{ K}$, it reduces to

$$E_{(\text{cell})} = E_{(\text{cell})}^{\ominus} - \frac{0.059}{2} \log \frac{[\text{Zn}^{2+}]}{[\text{Cu}^{2+}]} \quad (3.12)$$

We should use the same number of electrons (n) for both the electrodes and thus for the following cell

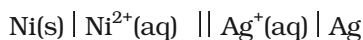

The cell reaction is $\text{Ni(s)} + 2\text{Ag}^{+}(\text{aq}) \rightarrow \text{Ni}^{2+}(\text{aq}) + 2\text{Ag(s)}$

The Nernst equation can be written as

$$E_{(\text{cell})} = E_{(\text{cell})}^{\ominus} - \frac{RT}{2F} \ln \frac{[\text{Ni}^{2+}]}{[\text{Ag}^{+}]^2}$$

and for a general electrochemical reaction of the type:

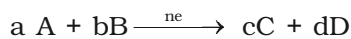

Nernst equation can be written as:

$$\begin{aligned} E_{(\text{cell})} &= E_{(\text{cell})}^{\ominus} - \frac{RT}{nF} \ln Q \\ &= E_{(\text{cell})}^{\ominus} - \frac{RT}{nF} \ln \frac{[\text{C}]^c [\text{D}]^d}{[\text{A}]^a [\text{B}]^b} \end{aligned} \quad (3.13)$$

Represent the cell in which the following reaction takes place *Example 3.1*

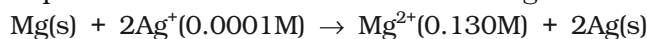

Calculate its $E_{(\text{cell})}$ if $E_{(\text{cell})}^{\ominus} = 3.17 \text{ V}$.

The cell can be written as $\text{Mg} \mid \text{Mg}^{2+}(0.130\text{M}) \parallel \text{Ag}^{+}(0.0001\text{M}) \mid \text{Ag}$ *Solution*

$$\begin{aligned} E_{(\text{cell})} &= E_{(\text{cell})}^{\ominus} - \frac{RT}{2F} \ln \frac{[\text{Mg}^{2+}]}{[\text{Ag}^{+}]^2} \\ &= 3.17 \text{ V} - \frac{0.059\text{V}}{2} \log \frac{0.130}{(0.0001)^2} = 3.17 \text{ V} - 0.21\text{V} = 2.96 \text{ V}. \end{aligned}$$

If the circuit in Daniell cell (Fig. 3.1) is closed then we note that the reaction

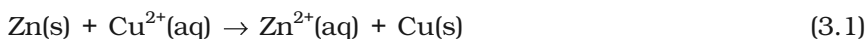

takes place and as time passes, the concentration of Zn^{2+} keeps on increasing while the concentration of Cu^{2+} keeps on decreasing. At the same time voltage of the cell as read on the voltmeter keeps on decreasing. After some time, we shall note that there is no change in the concentration of Cu^{2+} and Zn^{2+} ions and at the same time, voltmeter gives zero reading. This indicates that equilibrium has been attained. In this situation the Nernst equation may be written as:

$$E_{(\text{cell})} = 0 = E_{(\text{cell})}^{\ominus} - \frac{2.303RT}{2F} \log \frac{[\text{Zn}^{2+}]}{[\text{Cu}^{2+}]}$$

$$\text{or } E_{(\text{cell})}^{\ominus} = \frac{2.303RT}{2F} \log \frac{[\text{Zn}^{2+}]}{[\text{Cu}^{2+}]}$$

But at equilibrium,

3.3.1 Equilibrium Constant from Nernst Equation

$$\frac{[\text{Zn}^{2+}]}{[\text{Cu}^{2+}]} = K_c \text{ for the reaction 3.1}$$

and at $T = 298\text{K}$ the above equation can be written as

$$E_{(\text{cell})}^{\ominus} = \frac{0.059 \text{ V}}{2} \log K_c = 1.1 \text{ V} \quad (E_{(\text{cell})}^{\ominus} = 1.1\text{V})$$

$$\log K_c = \frac{(1.1\text{V} \times 2)}{0.059 \text{ V}} = 37.288$$

$$K_c = 2 \times 10^{37} \text{ at } 298\text{K}.$$

In general,

$$E_{(\text{cell})}^{\ominus} = \frac{2.303RT}{nF} \log K_c \quad (3.14)$$

Thus, Eq. (3.14) gives a relationship between equilibrium constant of the reaction and standard potential of the cell in which that reaction takes place. Thus, equilibrium constants of the reaction, difficult to measure otherwise, can be calculated from the corresponding E^{\ominus} value of the cell.

Example 3.2 Calculate the equilibrium constant of the reaction:

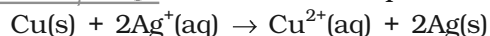

$$E_{(\text{cell})}^{\ominus} = 0.46 \text{ V}$$

Solution $E_{(\text{cell})}^{\ominus} = \frac{0.059 \text{ V}}{2} \log K_c = 0.46 \text{ V}$ or

$$\log K_c = \frac{0.46 \text{ V} \times 2}{0.059 \text{ V}} = 15.6$$

$$K_c = 3.92 \times 10^{15}$$

3.3.2 Electro-chemical Cell and Gibbs Energy of the Reaction

Electrical work done in one second is equal to electrical potential multiplied by total charge passed. If we want to obtain maximum work from a galvanic cell then charge has to be passed reversibly. The reversible work done by a galvanic cell is equal to decrease in its Gibbs energy and therefore, if the emf of the cell is E and nF is the amount of charge passed and $\Delta_r G$ is the Gibbs energy of the reaction, then

$$\Delta_r G = - nFE_{(\text{cell})} \quad (3.15)$$

It may be remembered that $E_{(\text{cell})}$ is an intensive parameter but $\Delta_r G$ is an extensive thermodynamic property and the value depends on n . Thus, if we write the reaction

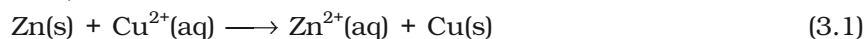

$$\Delta_r G = -2FE_{(\text{cell})}$$

but when we write the reaction

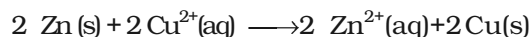

$$\Delta_r G = -4FE_{(\text{cell})}$$

If the concentration of all the reacting species is unity, then $E_{(\text{cell})} = E_{(\text{cell})}^\ominus$ and we have

$$\Delta_r G^\ominus = -nFE_{(\text{cell})}^\ominus \quad (3.16)$$

Thus, from the measurement of $E_{(\text{cell})}^\ominus$ we can obtain an important thermodynamic quantity, $\Delta_r G^\ominus$, standard Gibbs energy of the reaction. From the latter we can calculate equilibrium constant by the equation:

$$\Delta_r G^\ominus = -RT \ln K.$$

Example 3.3 The standard electrode potential for Daniell cell is 1.1V. Calculate the standard Gibbs energy for the reaction:
 $\text{Zn(s)} + \text{Cu}^{2+}(\text{aq}) \longrightarrow \text{Zn}^{2+}(\text{aq}) + \text{Cu(s)}$

Solution $\Delta_r G^\ominus = -nFE_{(\text{cell})}^\ominus$

n in the above equation is 2, $F = 96487 \text{ C mol}^{-1}$ and

$$E_{(\text{cell})}^\ominus = 1.1 \text{ V}$$

$$\begin{aligned} \text{Therefore, } \Delta_r G^\ominus &= -2 \times 1.1\text{V} \times 96487 \text{ C mol}^{-1} \\ &= -21227 \text{ J mol}^{-1} \\ &= -21.227 \text{ kJ mol}^{-1} \end{aligned}$$

Intext Questions

3.4 Calculate the potential of hydrogen electrode in contact with a solution whose pH is 10.

3.5 Calculate the emf of the cell in which the following reaction takes place
 $\text{Ni(s)} + 2\text{Ag}^+ (0.002 \text{ M}) \rightarrow \text{Ni}^{2+} (0.160 \text{ M}) + 2\text{Ag(s)}$

$$\text{Given that } E_{(\text{cell})}^\ominus = 1.05 \text{ V}$$

3.6 The cell in which the following reaction occurs:

$2\text{Fe}^{3+}(\text{aq}) + 2\text{I}^-(\text{aq}) \rightarrow 2\text{Fe}^{2+}(\text{aq}) + \text{I}_2(\text{s})$ has $E_{\text{cell}}^\ominus = 0.236 \text{ V}$ at 298 K. Calculate the standard Gibbs energy and the equilibrium constant of the cell reaction.

3.4 Conductance of Electrolytic Solutions

It is necessary to define a few terms before we consider the subject of conductance of electricity through electrolytic solutions. The electrical resistance is represented by the symbol 'R' and it is measured in ohm (Ω) which in terms of SI base units is equal to $(\text{kg m}^2)/(\text{s}^3 \text{ A}^2)$. It can be measured with the help of a Wheatstone bridge with which you are familiar

from your study of physics. The electrical resistance of any object is directly proportional to its length, l , and inversely proportional to its area of cross section, A . That is,

$$R \propto \frac{l}{A} \text{ or } R = \rho \frac{l}{A} \quad (3.17)$$

The constant of proportionality, ρ (Greek, rho), is called **resistivity** (specific resistance). Its SI units are ohm metre (Ω m) and quite often its submultiple, ohm centimetre (Ω cm) is also used. IUPAC recommends the use of the term resistivity over specific resistance and hence in the rest of the book we shall use the term resistivity. Physically, the resistivity for a substance is its resistance when it is one metre long and its area of cross section is one m^2 . It can be seen that:

$$1 \Omega \text{ m} = 100 \Omega \text{ cm} \text{ or } 1 \Omega \text{ cm} = 0.01 \Omega \text{ m}$$

The inverse of resistance, R , is called **conductance**, G , and we have the relation:

$$G = \frac{1}{R} = \frac{A}{\rho l} = \kappa \frac{A}{l} \quad (3.18)$$

The SI unit of conductance is siemens, represented by the symbol 'S' and is equal to ohm^{-1} (also known as mho) or Ω^{-1} . The inverse of resistivity, called **conductivity** (specific conductance) is represented by the symbol, κ (Greek, kappa). IUPAC has recommended the use of term conductivity over specific conductance and hence we shall use the term conductivity in the rest of the book. The SI units of conductivity are S m^{-1} but quite often, κ is expressed in S cm^{-1} . Conductivity of a material in S m^{-1} is its conductance when it is 1 m long and its area of cross section is 1 m^2 . It may be noted that $1 \text{ S cm}^{-1} = 100 \text{ S m}^{-1}$.

Table 3.2 The values of Conductivity of some Selected Materials at 298.15 K

Material	Conductivity/ S m^{-1}	Material	Conductivity/ S m^{-1}
Conductors		Aqueous Solutions	
Sodium	2.1×10^3	Pure water	3.5×10^{-5}
Copper	5.9×10^3	0.1 M HCl	3.91
Silver	6.2×10^3	0.01M KCl	0.14
Gold	4.5×10^3	0.01M NaCl	0.12
Iron	1.0×10^3	0.1 M HAc	0.047
Graphite	1.2×10	0.01M HAc	0.016
Insulators		Semiconductors	
Glass	1.0×10^{-16}	CuO	1×10^{-7}
Teflon	1.0×10^{-18}	Si	1.5×10^{-2}
		Ge	2.0

It can be seen from Table 3.2 that the magnitude of conductivity varies a great deal and depends on the nature of the material. It also depends on the temperature and pressure at which the measurements

are made. Materials are classified into conductors, insulators and semiconductors depending on the magnitude of their conductivity. Metals and their alloys have very large conductivity and are known as conductors. Certain non-metals like carbon-black, graphite and some organic polymers* are also electronically conducting. Substances like glass, ceramics, etc., having very low conductivity are known as insulators. Substances like silicon, doped silicon and gallium arsenide having conductivity between conductors and insulators are called semiconductors and are important electronic materials. Certain materials called superconductors by definition have zero resistivity or infinite conductivity. Earlier, only metals and their alloys at very low temperatures (0 to 15 K) were known to behave as superconductors, but nowadays a number of ceramic materials and mixed oxides are also known to show superconductivity at temperatures as high as 150 K.

Electrical conductance through metals is called metallic or electronic conductance and is due to the movement of electrons. The electronic conductance depends on

- (i) the nature and structure of the metal
- (ii) the number of valence electrons per atom
- (iii) temperature (it decreases with increase of temperature).

As the electrons enter at one end and go out through the other end, the composition of the metallic conductor remains unchanged. The mechanism of conductance through semiconductors is more complex.

We already know (Class XI, Unit 7) that even very pure water has small amounts of hydrogen and hydroxyl ions ($\sim 10^{-7}M$) which lend it very low conductivity ($3.5 \times 10^{-5} S m^{-1}$). When electrolytes are dissolved in water, they furnish their own ions in the solution hence its conductivity also increases. The conductance of electricity by ions present in the solutions is called electrolytic or ionic conductance. The conductivity of electrolytic (ionic) solutions depends on:

- (i) the nature of the electrolyte added
- (ii) size of the ions produced and their solvation
- (iii) the nature of the solvent and its viscosity
- (iv) concentration of the electrolyte
- (v) temperature (it increases with the increase of temperature).

Passage of direct current through ionic solution over a prolonged period can lead to change in its composition due to electrochemical reactions (Section 3.4.1).

* *Electronically conducting polymers – In 1977 MacDiarmid, Heeger and Shirakawa discovered that acetylene gas can be polymerised to produce a polymer, polyacetylene when exposed to vapours of iodine acquires metallic lustre and conductivity. Since then several organic conducting polymers have been made such as polyaniline, polypyrrole and polythiophene. These organic metals, being composed wholly of elements like carbon, hydrogen and occasionally nitrogen, oxygen or sulphur, are much lighter than normal metals and can be used for making light-weight batteries. Besides, they have the mechanical properties of polymers such as flexibility so that one can make electronic devices such as transistors that can bend like a sheet of plastic. For the discovery of conducting polymers, MacDiarmid, Heeger and Shirakawa were awarded the Nobel Prize in Chemistry for the year 2000.*

3.4.1 Measurement of the Conductivity of Ionic Solutions

We know that accurate measurement of an unknown resistance can be performed on a Wheatstone bridge. However, for measuring the resistance of an ionic solution we face two problems. Firstly, passing direct current (DC) changes the composition of the solution. Secondly, a solution cannot be connected to the bridge like a metallic wire or other solid conductor. The first difficulty is resolved by using an alternating current (AC) source of power. The second problem is solved by using a specially designed vessel called **conductivity cell**. It is available in several designs and two simple ones are shown in Fig. 3.4.

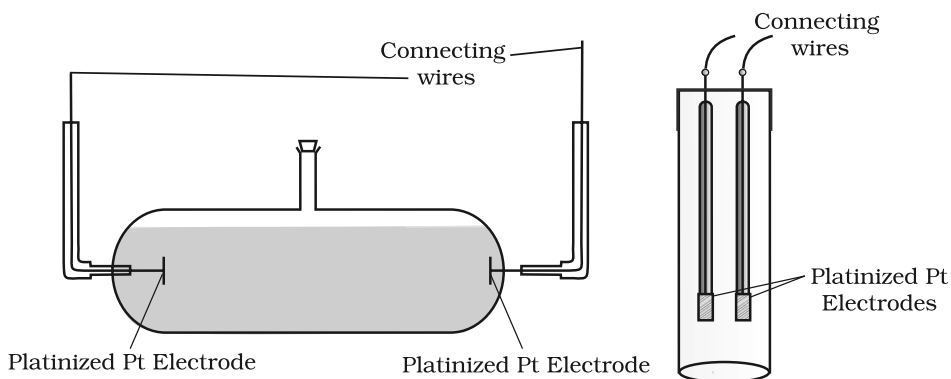

Fig. 3.4: Two different types of conductivity cells.

Basically it consists of two platinum electrodes coated with platinum black (finely divided metallic Pt is deposited on the electrodes electrochemically). These have area of cross section equal to 'A' and are separated by distance 'l'. Therefore, solution confined between these electrodes is a column of length l and area of cross section A. The resistance of such a column of solution is then given by the equation:

$$R = \rho \frac{l}{A} = \frac{l}{\kappa A} \quad (3.17)$$

The quantity l/A is called cell constant denoted by the symbol, G^* . It depends on the distance between the electrodes and their area of cross-section and has the dimension of length^{-1} and can be calculated if we know l and A . Measurement of l and A is not only inconvenient but also unreliable. The cell constant is usually determined by measuring the resistance of the cell containing a solution whose conductivity is already known. For this purpose, we generally use KCl solutions whose conductivity is known accurately at various concentrations (Table 3.3) and at different temperatures. The cell constant, G^* , is then given by the equation:

$$G^* = \frac{l}{A} = R \kappa \quad (3.18)$$

Molarity		Concentration	Conductivity	Molar Conductivity	
mol L ⁻¹	mol m ⁻³	S cm ⁻¹	S m ⁻¹	S cm ² mol ⁻¹	S m ² mol ⁻¹
1.000	1000	0.1113	11.13	111.3	111.3×10 ⁻⁴
0.100	100.0	0.0129	1.29	129.0	129.0×10 ⁻⁴
0.010	10.00	0.00141	0.141	141.0	141.0×10 ⁻⁴

Table 3.3
Conductivity and
Molar conductivity
of KCl solutions at
298.15K

Once the cell constant is determined, we can use it for measuring the resistance or conductivity of any solution. The set up for the measurement of the resistance is shown in Fig. 3.5.

It consists of two resistances R_3 and R_4 , a variable resistance R_1 and the conductivity cell having the unknown resistance R_2 . The Wheatstone bridge is fed by an oscillator O (a source of a.c. power in the audio frequency range 550 to 5000 cycles per second). P is a suitable detector (a headphone or other electronic device) and the bridge is balanced when no current passes through the detector. Under these conditions:

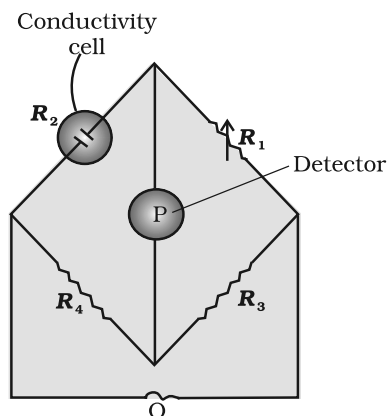

Fig. 3.5: Arrangement for measurement of resistance of a solution of an electrolyte.

$$\text{Unknown resistance } R_2 = \frac{R_1 R_4}{R_3} \quad (3.19)$$

These days, inexpensive conductivity meters are available which can directly read the conductance or resistance of the solution in the conductivity cell. Once the cell constant and the resistance of the solution in the cell is determined, the conductivity of the solution is given by the equation:

$$\kappa = \frac{\text{cell constant}}{R} = \frac{G^*}{R} \quad (3.20)$$

The conductivity of solutions of different electrolytes in the same solvent and at a given temperature differs due to charge and size of the ions in which they dissociate, the concentration of ions or ease with which the ions move under a potential gradient. It, therefore, becomes necessary to define a physically more meaningful quantity called **molar conductivity** denoted by the symbol Λ_m (Greek, lambda). It is related to the conductivity of the solution by the equation:

$$\text{Molar conductivity} = \Lambda_m = \frac{\kappa}{c} \quad (3.21)$$

In the above equation, if κ is expressed in S m^{-1} and the concentration,

c in mol m^{-3} then the units of Λ_m are in $\text{S m}^2 \text{mol}^{-1}$. It may be noted that:

$1 \text{ mol m}^{-3} = 1000(\text{L/m}^3) \times \text{molarity (mol/L)}$, and hence

$$\Lambda_m(\text{S m}^2 \text{mol}^{-1}) = \frac{\kappa (\text{S m}^{-1})}{1000 \text{ L m}^{-3} \times \text{molarity (mol L}^{-1}\text{)}}$$

If we use S cm^{-1} as the units for κ and mol cm^{-3} , the units of concentration, then the units for Λ_m are $\text{S cm}^2 \text{mol}^{-1}$. It can be calculated by using the equation:

$$L_m(\text{S cm}^2 \text{mol}^{-1}) = \frac{\kappa (\text{S cm}^{-1}) \times 1000(\text{cm}^3/\text{L})}{\text{molarity (mol/L)}}$$

Both type of units are used in literature and are related to each other by the equations:

$$1 \text{ S m}^2 \text{mol}^{-1} = 10^4 \text{ S cm}^2 \text{mol}^{-1} \text{ or}$$

$$1 \text{ S cm}^2 \text{mol}^{-1} = 10^{-4} \text{ S m}^2 \text{mol}^{-1}.$$

Example 3.4 Resistance of a conductivity cell filled with 0.1 mol L^{-1} KCl solution is 100Ω . If the resistance of the same cell when filled with 0.02 mol L^{-1} KCl solution is 520Ω , calculate the conductivity and molar conductivity of 0.02 mol L^{-1} KCl solution. The conductivity of 0.1 mol L^{-1} KCl solution is 1.29 S/m .

Solution The cell constant is given by the equation:

$$\text{Cell constant} = G^* = \text{conductivity} \times \text{resistance}$$

$$= 1.29 \text{ S/m} \times 100 \Omega = 129 \text{ m}^{-1} = 1.29 \text{ cm}^{-1}$$

$$\text{Conductivity of } 0.02 \text{ mol L}^{-1} \text{ KCl solution} = \text{cell constant} / \text{resistance}$$

$$= \frac{G^*}{R} = \frac{129 \text{ m}^{-1}}{520 \Omega} = 0.248 \text{ S m}^{-1}$$

$$\text{Concentration} = 0.02 \text{ mol L}^{-1}$$

$$= 1000 \times 0.02 \text{ mol m}^{-3}$$

$$= 20 \text{ mol m}^{-3}$$

$$\text{Molar conductivity} = \Lambda_m = \frac{\kappa}{c}$$

$$= \frac{248 \times 10^{-3} \text{ S m}^{-1}}{20 \text{ mol m}^{-3}}$$

$$= 124 \times 10^{-4} \text{ S m}^2 \text{mol}^{-1}$$

$$\text{Alternatively, } \kappa = \frac{1.29 \text{ cm}^{-1}}{520 \Omega}$$

$$= 0.248 \times 10^{-2} \text{ S cm}^{-1}$$

$$\text{and } \Lambda_m = \kappa \times 1000 \text{ cm}^3 \text{ L}^{-1} \text{ molarity}^{-1}$$

$$= \frac{0.248 \times 10^{-2} \text{ S cm}^{-1} \times 1000 \text{ cm}^3 \text{ L}^{-1}}{0.02 \text{ mol L}^{-1}}$$

$$= 124 \text{ S cm}^2 \text{ mol}^{-1}$$

The electrical resistance of a column of 0.05 mol L^{-1} NaOH solution *Example 3.5* of diameter 1 cm and length 50 cm is $5.55 \times 10^3 \text{ ohm}$. Calculate its resistivity, conductivity and molar conductivity.

$$A = \pi r^2 = 3.14 \times 0.5^2 \text{ cm}^2 = 0.785 \text{ cm}^2 = 0.785 \times 10^{-4} \text{ m}^2$$

$$l = 50 \text{ cm} = 0.5 \text{ m}$$

Solution

$$R = \frac{\rho l}{A} \quad \text{or} \quad \rho = \frac{RA}{l} = \frac{5.55 \times 10^3 \Omega \times 0.785 \text{ cm}^2}{50 \text{ cm}} = 87.135 \Omega \text{ cm}$$

$$\text{Conductivity} = \kappa = \frac{1}{\rho} = \left(\frac{1}{87.135} \right) \text{ S cm}^{-1}$$

$$= 0.01148 \text{ S cm}^{-1}$$

$$\text{Molar conductivity, } \Lambda_m = \frac{\kappa \times 1000}{c} \text{ cm}^3 \text{ L}^{-1}$$

$$= \frac{0.01148 \text{ S cm}^{-1} \times 1000 \text{ cm}^3 \text{ L}^{-1}}{0.05 \text{ mol L}^{-1}}$$

$$= 229.6 \text{ S cm}^2 \text{ mol}^{-1}$$

If we want to calculate the values of different quantities in terms of 'm' instead of 'cm',

$$\rho = \frac{RA}{l}$$

$$= \frac{5.55 \times 10^3 \Omega \times 0.785 \times 10^{-4} \text{ m}^2}{0.5 \text{ m}}$$

$$= 87.135 \times 10^{-2} \Omega \text{ m}$$

$$\kappa = \frac{1}{\rho} = \frac{100}{87.135} \Omega \text{ m} = 1.148 \text{ S m}^{-1}$$

$$\text{and } \Lambda_m = \frac{\kappa}{c} = \frac{1.148 \text{ S m}^{-1}}{50 \text{ mol m}^{-3}}$$

$$= 229.6 \times 10^{-4} \text{ S m}^2 \text{ mol}^{-1}.$$

Both conductivity and molar conductivity change with the concentration of the electrolyte. Conductivity always decreases with decrease in concentration both, for weak and strong electrolytes. This can be explained by the fact that the number of ions per unit volume that carry the current in a solution decreases on dilution. The conductivity of a solution at any given concentration is the conductance of one unit volume of solution kept between two

3.4.2 Variation of Conductivity and Molar Conductivity with Concentration

platinum electrodes with unit area of cross section and at a distance of unit length. This is clear from the equation:

$$G = \frac{\kappa A}{l} = \kappa \quad (\text{both } A \text{ and } l \text{ are unity in their appropriate units in}$$

m or cm)

Molar conductivity of a solution at a given concentration is the conductance of the volume V of solution containing one mole of electrolyte kept between two electrodes with area of cross section A and distance of unit length. Therefore,

$$\Lambda_m = \frac{\kappa A}{l} = \kappa$$

Since $l = 1$ and $A = V$ (volume containing 1 mole of electrolyte)

$$\Lambda_m = \kappa V \quad (3.22)$$

Molar conductivity increases with decrease in concentration. This is because the total volume, V , of solution containing one mole of electrolyte also increases. It has been found that decrease in κ on dilution of a solution is more than compensated by increase in its volume. Physically, it means that at a given concentration, Λ_m can be defined as the conductance of the electrolytic solution kept between the electrodes of a conductivity cell at unit distance but having area of cross section large enough to accommodate sufficient volume of solution that contains one mole of the electrolyte. When concentration approaches zero, the molar conductivity is known as **limiting molar conductivity** and is represented by the symbol \ddot{E}_m° . The variation in Λ_m with concentration is different (Fig. 3.6) for strong and weak electrolytes.

For strong electrolytes, Λ increases slowly with dilution and can be represented by the equation:

$$\Lambda_m = \ddot{E}_m^\circ - A c^{1/2} \quad (3.23)$$

It can be seen that if we plot (Fig. 3.12) Λ_m against $c^{1/2}$, we obtain a straight line with intercept equal to \ddot{E}_m° and slope equal to $-A$. The value of the constant 'A' for a given solvent and temperature depends on the type of electrolyte i.e., the charges on the cation and anion produced on the dissociation of the electrolyte in

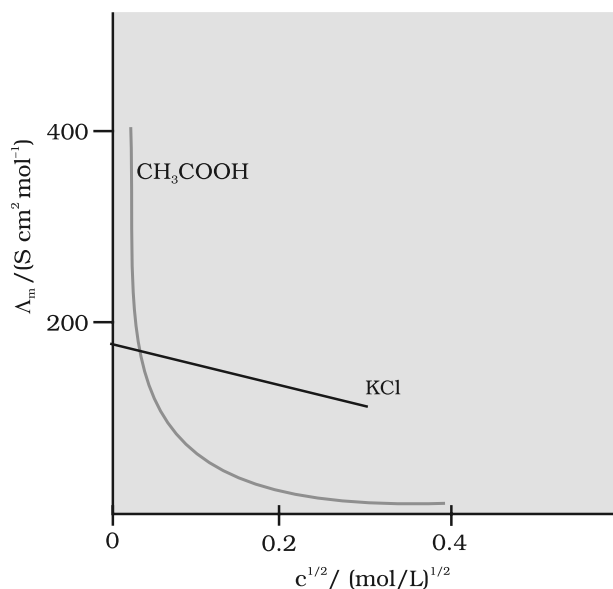

Strong Electrolytes

Fig. 3.6: Molar conductivity versus $c^{1/2}$ for acetic acid (weak electrolyte) and potassium chloride (strong electrolyte) in aqueous solutions.

the solution. Thus, NaCl, CaCl₂, MgSO₄ are known as 1-1, 2-1 and 2-2 electrolytes respectively. All electrolytes of a particular type have the same value for 'A'.

The molar conductivity of KCl solutions at different concentrations at *Example 3.6* 298 K are given below:

$c/\text{mol L}^{-1}$	$\Lambda_m/\text{S cm}^2 \text{mol}^{-1}$
0.000198	148.61
0.000309	148.29
0.000521	147.81
0.000989	147.09

Show that a plot between \ddot{E}_m and $c^{1/2}$ is a straight line. Determine the values of \ddot{E}_m° and A for KCl.

Taking the square root of concentration we obtain:

$c^{1/2}/(\text{mol L}^{-1})^{1/2}$	$\Lambda_m/\text{S cm}^2 \text{mol}^{-1}$
0.01407	148.61
0.01758	148.29
0.02283	147.81
0.03145	147.09

Solution

A plot of Λ_m (y-axis) and $c^{1/2}$ (x-axis) is shown in (Fig. 3.7).

It can be seen that it is nearly a straight line. From the intercept ($c^{1/2} = 0$), we find that $\ddot{E}_m^\circ = 150.0 \text{ S cm}^2 \text{mol}^{-1}$ and

$A = -\text{slope} = 87.46 \text{ S cm}^2 \text{mol}^{-1}/(\text{mol/L}^{-1})^{1/2}$.

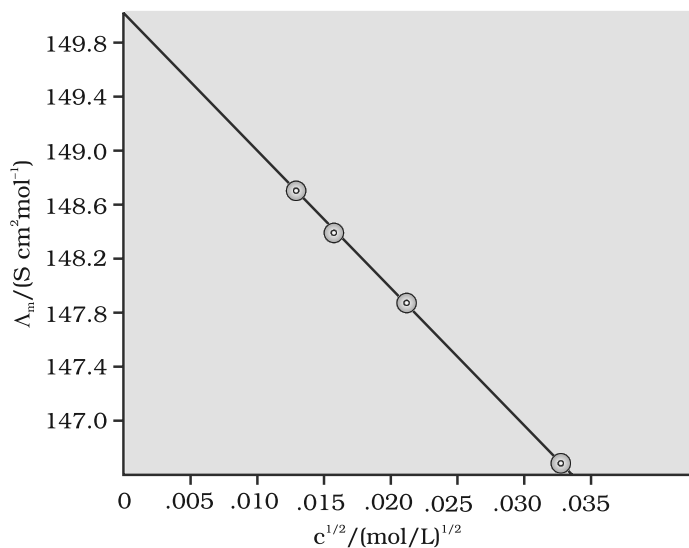

Fig. 3.7: Variation of \ddot{E}_m against $c^{1/2}$.

Kohlrausch examined \ddot{E}_m° values for a number of strong electrolytes and observed certain regularities. He noted that the difference in \ddot{E}_m° of the electrolytes NaX and KX for any X is nearly constant. For example at 298 K:

$$\begin{aligned} \ddot{E}_m^\circ(\text{KCl}) - \ddot{E}_m^\circ(\text{NaCl}) &= \ddot{E}_m^\circ(\text{KBr}) - \ddot{E}_m^\circ(\text{NaBr}) \\ &= \ddot{E}_m^\circ(\text{KI}) - \ddot{E}_m^\circ(\text{NaI}) \approx 23.4 \text{ S cm}^2 \text{ mol}^{-1} \end{aligned}$$

and similarly it was found that

$$\ddot{E}_m^\circ(\text{NaBr}) - \ddot{E}_m^\circ(\text{NaCl}) = \ddot{E}_m^\circ(\text{KBr}) - \ddot{E}_m^\circ(\text{KCl}) \approx 1.8 \text{ S cm}^2 \text{ mol}^{-1}$$

On the basis of the above observations he enunciated **Kohlrausch law of independent migration of ions**. The law states that *limiting molar conductivity of an electrolyte can be represented as the sum of the individual contributions of the anion and cation of the electrolyte. Thus, if $\lambda_{\text{Na}^+}^\circ$ and $\lambda_{\text{Cl}^-}^\circ$ are limiting molar conductivity of the sodium and chloride ions respectively, then the limiting molar conductivity for sodium chloride is given by the equation:*

$$\ddot{E}_m^\circ(\text{NaCl}) = \lambda_{\text{Na}^+}^\circ + \lambda_{\text{Cl}^-}^\circ \quad (3.24)$$

In general, if an electrolyte on dissociation gives v_+ cations and v_- anions then its limiting molar conductivity is given by:

$$\ddot{E}_m^\circ = v_+ \lambda_+^\circ + v_- \lambda_-^\circ \quad (3.25)$$

Here, λ_+° and λ_-° are the limiting molar conductivities of the cation and anion respectively. The values of λ° for some cations and anions at 298 K are given in Table 3.4.

Ion	$\lambda^\circ/(\text{S cm}^2 \text{ mol}^{-1})$	Ion	$\lambda^\circ/(\text{S cm}^2 \text{ mol}^{-1})$
H ⁺	349.6	OH ⁻	199.1
Na ⁺	50.1	Cl ⁻	76.3
K ⁺	73.5	Br ⁻	78.1
Ca ²⁺	119.0	CH ₃ COO ⁻	40.9
Mg ²⁺	106.0	SO ₄ ²⁻	160.0

Table 3.4
Limiting molar conductivity for some ions in water at 298 K

Weak electrolytes like acetic acid have lower degree of dissociation at higher concentrations and hence for such electrolytes, the change in Λ_m with dilution is due to increase in the degree of dissociation and consequently the number of ions in total volume of solution that contains 1 mol of electrolyte. In such cases \ddot{E}_m increases steeply (Fig. 3.12) on dilution, especially near lower concentrations. Therefore, \ddot{E}_m° cannot be obtained by extrapolation of Λ_m to zero concentration. At infinite dilution (i.e., concentration $c \rightarrow$ zero) electrolyte dissociates completely ($\alpha = 1$), but at such low concentration the conductivity of the solution is so low that it cannot be measured accurately. Therefore, \ddot{E}_m° for weak electrolytes is obtained by using Kohlrausch law of independent migration of ions (Example 3.8). At any concentration c , if α is the degree of dissociation then it can be approximated to the ratio of molar conductivity \ddot{E}_m at the concentration c to limiting molar conductivity, \ddot{E}_m° . Thus we have:

Weak electrolytes

$$\alpha = \frac{A_m}{A_m^\circ} \quad (3.26)$$

But we know that for a weak electrolyte like acetic acid (Class XI, Unit 7),

$$K_a = \frac{c\alpha^2}{(1-\alpha)} = \frac{cA_m^2}{A_m^{\circ 2} \left(1 - \frac{A_m}{A_m^\circ}\right)} = \frac{cA_m^2}{A_m^\circ (A_m^\circ - A_m)} \quad (3.27)$$

Using Kohlrausch law of independent migration of ions, it is possible to calculate \ddot{E}_m° for any electrolyte from the λ° of individual ions. Moreover, for weak electrolytes like acetic acid it is possible to determine the value of its dissociation constant once we know the \ddot{E}_m° and A_m at a given concentration c .

Applications of Kohlrausch law

Calculate \ddot{E}_m° for CaCl_2 and MgSO_4 from the data given in Table 3.4.

Example 3.7

We know from Kohlrausch law that

Solution

$$\begin{aligned} A_{m(\text{CaCl}_2)}^\circ &= \lambda_{\text{Ca}^{2+}}^\circ + 2\lambda_{\text{Cl}^-}^\circ = 119.0 \text{ S cm}^2 \text{ mol}^{-1} + 2(76.3) \text{ S cm}^2 \text{ mol}^{-1} \\ &= (119.0 + 152.6) \text{ S cm}^2 \text{ mol}^{-1} \\ &= 271.6 \text{ S cm}^2 \text{ mol}^{-1} \end{aligned}$$

$$\begin{aligned} A_{m(\text{MgSO}_4)}^\circ &= \lambda_{\text{Mg}^{2+}}^\circ + \lambda_{\text{SO}_4^{2-}}^\circ = 106.0 \text{ S cm}^2 \text{ mol}^{-1} + 160.0 \text{ S cm}^2 \text{ mol}^{-1} \\ &= 266 \text{ S cm}^2 \text{ mol}^{-1} . \end{aligned}$$

\ddot{E}_m° for NaCl, HCl and NaAc are 126.4, 425.9 and 91.0 S cm² mol⁻¹ respectively. Calculate A° for HAc.

Example 3.8

$$\begin{aligned} A_{m(\text{HAc})}^\circ &= \lambda_{\text{H}^+}^\circ + \lambda_{\text{Ac}^-}^\circ = \lambda_{\text{H}^+}^\circ + \lambda_{\text{Cl}^-}^\circ + \lambda_{\text{Ac}^-}^\circ + \lambda_{\text{Na}^+}^\circ - \lambda_{\text{Cl}^-}^\circ - \lambda_{\text{Na}^+}^\circ \\ &= A_{m(\text{HCl})}^\circ + A_{m(\text{NaAc})}^\circ - A_{m(\text{NaCl})}^\circ \\ &= (425.9 + 91.0 - 126.4) \text{ S cm}^2 \text{ mol}^{-1} \\ &= 390.5 \text{ S cm}^2 \text{ mol}^{-1} . \end{aligned}$$

Solution

The conductivity of 0.001028 mol L⁻¹ acetic acid is 4.95×10^{-5} S cm⁻¹. Calculate its dissociation constant if \ddot{E}_m° for acetic acid is 390.5 S cm² mol⁻¹.

Example 3.9

$$A_m = \frac{\kappa}{c} = \frac{4.95 \times 10^{-5} \text{ S cm}^{-1}}{0.001028 \text{ mol L}^{-1}} \times \frac{1000 \text{ cm}^3}{\text{L}} = 48.15 \text{ S cm}^2 \text{ mol}^{-1}$$

Solution

$$\alpha = \frac{A_m}{A_m^\circ} = \frac{48.15 \text{ S cm}^2 \text{ mol}^{-1}}{390.5 \text{ S cm}^2 \text{ mol}^{-1}} = 0.1233$$

$$K = \frac{c\alpha^2}{(1-\alpha)} = \frac{0.001028 \text{ mol L}^{-1} \times (0.1233)^2}{1-0.1233} = 1.78 \times 10^{-5} \text{ mol L}^{-1}$$

Intext Questions

- 3.7** Why does the conductivity of a solution decrease with dilution?
- 3.8** Suggest a way to determine the Λ_m° value of water.
- 3.9** The molar conductivity of 0.025 mol L⁻¹ methanoic acid is 46.1 S cm² mol⁻¹. Calculate its degree of dissociation and dissociation constant. Given $\lambda^0(\text{H}^+) = 349.6 \text{ S cm}^2 \text{ mol}^{-1}$ and $\lambda^0(\text{HCOO}^-) = 54.6 \text{ S cm}^2 \text{ mol}^{-1}$

3.5 Electrolytic Cells and Electrolysis

In an **electrolytic cell** external source of voltage is used to bring about a chemical reaction. The electrochemical processes are of great importance in the laboratory and the chemical industry. One of the simplest electrolytic cell consists of two copper strips dipping in an aqueous solution of copper sulphate. If a DC voltage is applied to the two electrodes, then Cu²⁺ ions discharge at the cathode (negatively charged) and the following reaction takes place:



Copper metal is deposited on the cathode. At the anode, copper is converted into Cu²⁺ ions by the reaction:



Thus copper is dissolved (oxidised) at anode and deposited (reduced) at cathode. This is the basis for an industrial process in which impure copper is converted into copper of high purity. The impure copper is made an anode that dissolves on passing current and pure copper is deposited at the cathode. Many metals like Na, Mg, Al, etc. are produced on large scale by electrochemical reduction of their respective cations where no suitable chemical reducing agents are available for this purpose.

Sodium and magnesium metals are produced by the electrolysis of their fused chlorides and aluminium is produced (Class XII, Unit 6) by electrolysis of aluminium oxide in presence of cryolite.

Quantitative Aspects of Electrolysis

Faraday's Laws of Electrolysis

1. First Law

Michael Faraday was the first scientist who described the quantitative aspects of electrolysis. Now Faraday's laws also flow from what has been discussed earlier.

After his extensive investigations on electrolysis of solutions and melts of electrolytes, Faraday published his results during 1833-34 in the form of the following well known Faraday's two laws of electrolysis:

The amount of chemical reaction which occurs at any electrode during electrolysis by a current is proportional to the quantity of electricity passed through the electrolyte (solution or melt).

2. Second Law

The amounts of different substances liberated by the same quantity of electricity passing through the electrolytic solution are proportional to their chemical equivalent weights (Atomic Mass of Metal ÷ Number of electrons required to reduce the cation).

There were no constant current sources available during Faraday's times. The general practice was to put a coulometer (a standard electrolytic cell) for determining the quantity of electricity passed from the amount of metal (generally silver or copper) deposited or consumed. However, coulometers are now obsolete and we now have constant current (I) sources available and the quantity of electricity Q , passed is given by

$$Q = It$$

Q is in coulombs when I is in ampere and t is in second.

The amount of electricity (or charge) required for oxidation or reduction depends on the stoichiometry of the electrode reaction. For example, in the reaction:



One mole of the electron is required for the reduction of one mole of silver ions. We know that charge on one electron is equal to $1.6021 \times 10^{-19} \text{C}$. Therefore, the charge on one mole of electrons is equal to:

$$N_A \times 1.6021 \times 10^{-19} \text{ C} = 6.02 \times 10^{23} \text{ mol}^{-1} \times 1.6021 \times 10^{-19} \text{ C} = 96487 \text{ C mol}^{-1}$$

This quantity of electricity is called **Faraday** and is represented by the symbol **F**.

For approximate calculations we use $1\text{F} \approx 96500 \text{ C mol}^{-1}$.

For the electrode reactions:



It is obvious that one mole of Mg^{2+} and Al^{3+} require 2 mol of electrons (2F) and 3 mol of electrons (3F) respectively. The charge passed through the electrolytic cell during electrolysis is equal to the product of current in amperes and time in seconds. In commercial production of metals, current as high as 50,000 amperes are used that amounts to about 0.518 F per second.

A solution of CuSO_4 is electrolysed for 10 minutes with a current of 1.5 amperes. What is the mass of copper deposited at the cathode?

Example 3.10

$$t = 600 \text{ s} \quad \text{charge} = \text{current} \times \text{time} = 1.5 \text{ A} \times 600 \text{ s} = 900 \text{ C}$$

Solution

According to the reaction:

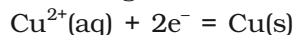

We require 2F or $2 \times 96487 \text{ C}$ to deposit 1 mol or 63 g of Cu.

$$\text{For } 900 \text{ C, the mass of Cu deposited} = (63 \text{ g mol}^{-1} \times 900 \text{ C}) / (2 \times 96487 \text{ C mol}^{-1}) = 0.2938 \text{ g.}$$

Products of electrolysis depend on the nature of material being electrolysed and the type of electrodes being used. If the electrode is inert (e.g., platinum or gold), it does not participate in the chemical reaction and acts only as source or sink for electrons. On the other hand, if the electrode is reactive, it participates in the electrode reaction. Thus, the products of electrolysis may be different for reactive and inert

3.5.1 Products of Electrolysis

electrodes. The products of electrolysis depend on the different oxidising and reducing species present in the electrolytic cell and their standard electrode potentials. Moreover, some of the electrochemical processes although feasible, are so slow kinetically that at lower voltages these don't seem to take place and extra potential (called *overpotential*) has to be applied, which makes such process more difficult to occur.

For example, if we use molten NaCl, the products of electrolysis are sodium metal and Cl₂ gas. Here we have only one cation (Na⁺) which is reduced at the cathode (Na⁺ + e⁻ → Na) and one anion (Cl⁻) which is oxidised at the anode (Cl⁻ → ½Cl₂ + e⁻). During the electrolysis of aqueous sodium chloride solution, the products are NaOH, Cl₂ and H₂. In this case besides Na⁺ and Cl⁻ ions we also have H⁺ and OH⁻ ions along with the solvent molecules, H₂O.

At the cathode there is competition between the following reduction reactions:

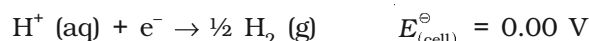
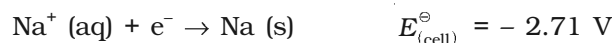

The reaction with higher value of E^{\ominus} is preferred and, therefore, the reaction at the cathode during electrolysis is:



but H⁺ (aq) is produced by the dissociation of H₂O, i.e.,



Therefore, the net reaction at the cathode may be written as the sum of (3.33) and (3.34) and we have



At the anode the following oxidation reactions are possible:

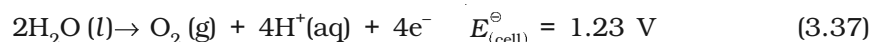

The reaction at anode with lower value of E^{\ominus} is preferred and therefore, water should get oxidised in preference to Cl⁻ (aq). However, on account of overpotential of oxygen, reaction (3.36) is preferred. Thus, the net reactions may be summarised as:

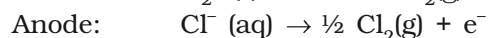
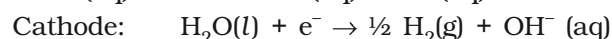
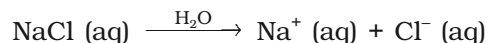

Net reaction:

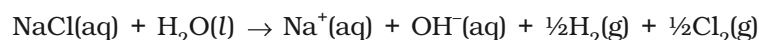

The standard electrode potentials are replaced by electrode potentials given by Nernst equation (Eq. 3.8) to take into account the concentration effects. During the electrolysis of sulphuric acid, the following processes are possible at the anode:

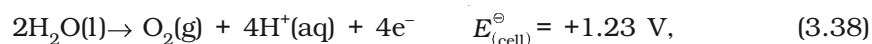



For dilute sulphuric acid, reaction (3.38) is preferred but at higher concentrations of H_2SO_4 process, reaction (3.39) is preferred.

Intext Questions

3.10 If a current of 0.5 ampere flows through a metallic wire for 2 hours, then how many electrons would flow through the wire?

3.11 Suggest a list of metals that are extracted electrolytically.

3.12 Consider the reaction:

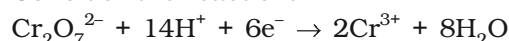

What is the quantity of electricity in coulombs needed to reduce 1 mol of $\text{Cr}_2\text{O}_7^{2-}$?

Any battery (actually it may have one or more than one cell connected in series) or cell that we use as a source of electrical energy is basically a galvanic cell where the chemical energy of the redox reaction is converted into electrical energy. However, for a battery to be of practical use it should be reasonably light, compact and its voltage should not vary appreciably during its use. There are mainly two types of batteries.

In the primary batteries, the reaction occurs only once and after use over a period of time battery becomes dead and cannot be reused again. The most familiar example of this type is the dry cell (known as Leclanche cell after its discoverer) which is used commonly in our transistors and clocks. The cell consists of a zinc container that also acts as anode and the cathode is a carbon (graphite) rod surrounded by powdered manganese dioxide and carbon (Fig.3.8). The space between the electrodes is filled by a moist paste of ammonium chloride (NH_4Cl) and zinc chloride (ZnCl_2). The electrode reactions are complex, but they can be written approximately as follows :

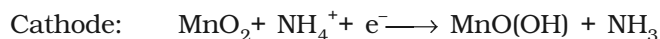
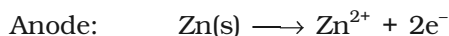

In the reaction at cathode, manganese is reduced from the + 4 oxidation state to the +3 state. Ammonia produced in the reaction forms a complex with Zn^{2+} to give $[\text{Zn}(\text{NH}_3)_4]^{2+}$. The cell has a potential of nearly 1.5 V.

Mercury cell, (Fig. 3.9) suitable for low current devices like hearing aids, watches, etc. consists of zinc – mercury amalgam as anode and a paste of HgO and carbon as the cathode. The electrolyte is a paste of KOH and ZnO . The electrode reactions for the cell are given below:

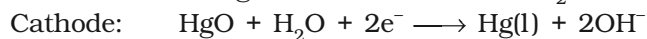

3.6 Batteries

3.6.1 Primary Batteries

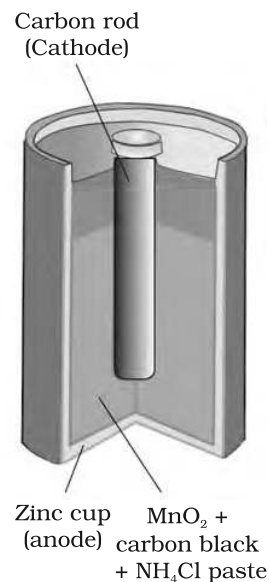

Fig. 3.8: A commercial dry cell consists of a graphite (carbon) cathode in a zinc container; the latter acts as the anode.

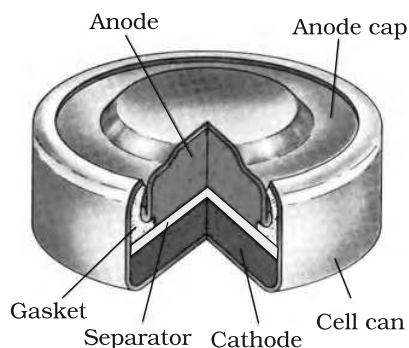

Fig. 3.9: Commonly used mercury cell. The reducing agent is zinc and the oxidising agent is mercury (II) oxide.

The overall reaction is represented by



The cell potential is approximately 1.35 V and remains constant during its life as the overall reaction does not involve any ion in solution whose concentration can change during its life time.

3.6.2 Secondary Batteries

A secondary cell after use can be recharged by passing current through it in the opposite direction so that it can be used again. A good secondary cell can undergo a large number of discharging and charging cycles. The most important secondary cell is the lead storage battery (Fig. 3.10) commonly used in

automobiles and invertors. It consists of a lead anode and a grid of lead packed with lead dioxide (PbO_2) as cathode. A 38% solution of sulphuric acid is used as an electrolyte.

The cell reactions when the battery is in use are given below:

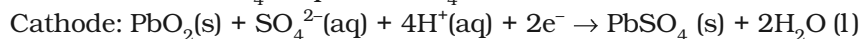
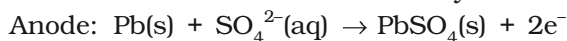

i.e., overall cell reaction consisting of cathode and anode reactions is:

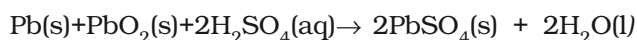

On charging the battery the reaction is reversed and $\text{PbSO}_4(\text{s})$ on anode and cathode is converted into Pb and PbO_2 , respectively.

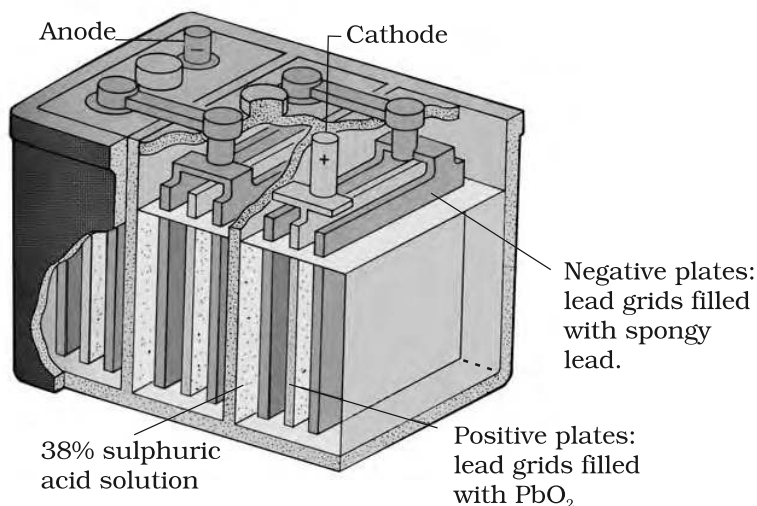

Fig. 3.10: The Lead storage battery.

Another important secondary cell is the nickel-cadmium cell (Fig. 3.11) which has longer life than the lead storage cell but more expensive to manufacture. We shall not go into details of working of the cell and the electrode reactions during charging and discharging. The overall reaction during discharge is:

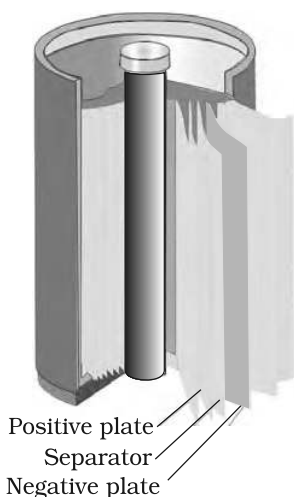

Fig. 3.11: A rechargeable nickel-cadmium cell in a jelly roll arrangement and separated by a layer soaked in moist sodium or potassium hydroxide.

Production of electricity by thermal plants is not a very efficient method and is a major source of pollution. In such plants, the chemical energy

3.7 Fuel Cells

(heat of combustion) of fossil fuels (coal, gas or oil) is first used for converting water into high pressure steam. This is then used to run a turbine to produce electricity. We know that a galvanic cell directly converts chemical energy into electricity and is highly efficient. It is now possible to make such cells in which reactants are fed continuously to the electrodes and products are removed continuously from the electrolyte compartment. Galvanic cells that are designed to convert the energy of combustion of fuels like hydrogen, methane, methanol, etc. directly into electrical energy are called **fuel cells**.

One of the most successful fuel cells uses the reaction of hydrogen with oxygen to form water (Fig. 3.12). The cell was used for providing electrical power in the Apollo space programme. The water vapours produced during the reaction were condensed and added to the drinking water supply for the astronauts. In the cell, hydrogen and oxygen are bubbled through porous carbon electrodes into concentrated aqueous sodium hydroxide solution. Catalysts like finely divided platinum or palladium metal are incorporated into the electrodes for increasing the rate of electrode reactions. The electrode reactions are given below:

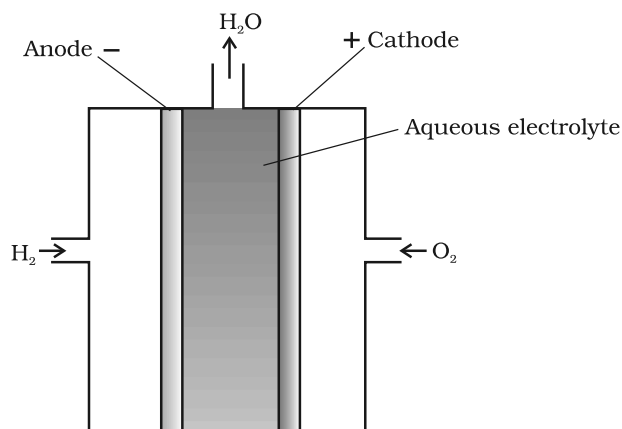
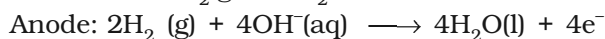
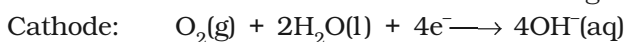
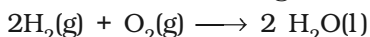

Fig. 3.12: Fuel cell using H_2 and O_2 produces electricity.

3.8 Corrosion

Overall reaction being:



The cell runs continuously as long as the reactants are supplied. Fuel cells produce electricity with an efficiency of about 70 % compared to thermal plants whose efficiency is about 40%. There has been tremendous progress in the development of new electrode materials, better catalysts and electrolytes for increasing the efficiency of fuel cells. These have been used in automobiles on an experimental basis. Fuel cells are pollution free and in view of their future importance, a variety of fuel cells have been fabricated and tried.

Corrosion slowly coats the surfaces of metallic objects with oxides or other salts of the metal. The rusting of iron, tarnishing of silver, development of green coating on copper and bronze are some of the examples of corrosion. It causes enormous damage to buildings, bridges, ships and to all objects made of metals especially that of iron. We lose crores of rupees every year on account of corrosion.

In corrosion, a metal is oxidised by loss of electrons to oxygen and formation of oxides. Corrosion of iron (commonly known as rusting) occurs in presence of water and air. The chemistry of corrosion is quite complex but it may be considered essentially as an electrochemical phenomenon. At a particular spot (Fig. 3.13) of an object made of iron, oxidation takes place and that spot behaves as anode and we can write the reaction

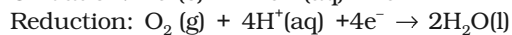
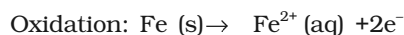
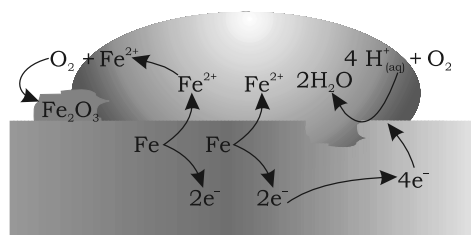
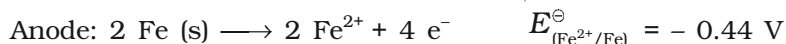

Atmospheric

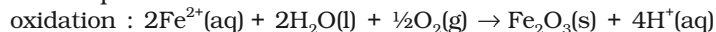
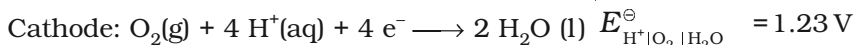
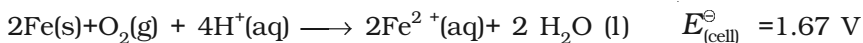

Fig. 3.13: Corrosion of iron in atmosphere.

acidic oxides from the atmosphere). This spot behaves as cathode with the reaction



The overall reaction being:



The ferrous ions are further oxidised by atmospheric oxygen to ferric ions which come out as rust in the form of hydrated ferric oxide ($\text{Fe}_2\text{O}_3 \cdot x \text{H}_2\text{O}$) and with further production of hydrogen ions.

Prevention of corrosion is of prime importance. It not only saves money but also helps in preventing accidents such as a bridge collapse or failure of a key component due to corrosion. One of the simplest methods of preventing corrosion is to prevent the surface of the metallic object to come in contact with atmosphere. This can be done by covering the surface with paint or by some chemicals (e.g. bisphenol). Another simple method is to cover the surface by other metals (Sn, Zn, etc.) that are inert or react to save the object. An electrochemical method is to provide a sacrificial electrode of another metal (like Mg, Zn, etc.) which corrodes itself but saves the object.

Intext Questions

- 3.13** Write the chemistry of recharging the lead storage battery, highlighting all the materials that are involved during recharging.
- 3.14** Suggest two materials other than hydrogen that can be used as fuels in fuel cells.
- 3.15** Explain how rusting of iron is envisaged as setting up of an electrochemical cell.

The Hydrogen Economy

At present the main source of energy that is driving our economy is fossil fuels such as coal, oil and gas. As more people on the planet aspire to improve their standard of living, their energy requirement will increase. In fact, the per capita consumption of energy used is a measure of development. Of course, it is assumed that energy is used for productive purpose and not merely wasted. We are already aware that carbon dioxide produced by the combustion of fossil fuels is resulting in the 'Greenhouse Effect'. This is leading to a rise in the temperature of the Earth's surface, causing polar ice to melt and ocean levels to rise. This will flood low-lying areas along the coast and some island nations such as Maldives face total submergence. In order to avoid such a catastrophe, we need to limit our use of carbonaceous fuels. Hydrogen provides an ideal alternative as its combustion results in water only. Hydrogen production must come from splitting water using solar energy. Therefore, hydrogen can be used as a renewable and non polluting source of energy. This is the vision of the Hydrogen Economy. Both the production of hydrogen by electrolysis of water and hydrogen combustion in a fuel cell will be important in the future. And both these technologies are based on electrochemical principles.

Summary

An **electrochemical cell** consists of two metallic electrodes dipping in electrolytic solution(s). Thus an important component of the electrochemical cell is the ionic conductor or electrolyte. Electrochemical cells are of two types. In **galvanic cell**, the **chemical**

energy of a **spontaneous redox reaction** is converted into electrical work, whereas in an electrolytic cell, electrical energy is used to carry out a **non-spontaneous redox reaction**. The **standard electrode potential** for any electrode dipping in an appropriate solution is defined with respect to standard electrode potential of **hydrogen electrode** taken as zero. The standard potential of the cell can be obtained by taking the difference of the standard potentials of cathode and anode ($E_{\text{cell}}^{\ominus} = E_{\text{cathode}}^{\ominus} - E_{\text{anode}}^{\ominus}$). The standard potential of the cells are related to standard Gibbs energy ($\Delta_r G^{\ominus} = -nFE_{\text{cell}}^{\ominus}$) and **equilibrium constant** ($\Delta_r G^{\ominus} = -RT \ln K$) of the reaction taking place in the cell. Concentration dependence of the potentials of the electrodes and the cells are given by Nernst equation.

The **conductivity**, κ , of an electrolytic solution depends on the concentration of the electrolyte, nature of solvent and temperature. **Molar conductivity**, \tilde{E}_m , is defined by $= \kappa / c$ where c is the concentration. Conductivity decreases but molar conductivity increases with decrease in concentration. It increases slowly with decrease in concentration for strong electrolytes while the increase is very steep for weak electrolytes in very dilute solutions. Kohlrausch found that molar conductivity at infinite dilution, for an electrolyte is sum of the contribution of the molar conductivity of the ions in which it dissociates. It is known as **law of independent migration of ions** and has many applications. Ions conduct electricity through the solution but oxidation and reduction of the ions take place at the electrodes in an electrochemical cell. **Batteries and fuel cells** are very useful forms of galvanic cell. **Corrosion** of metals is essentially an **electrochemical phenomenon**. Electrochemical principles are relevant to the **Hydrogen Economy**.

Exercises

- 3.1** Arrange the following metals in the order in which they displace each other from the solution of their salts.
Al, Cu, Fe, Mg and Zn.
- 3.2** Given the standard electrode potentials,
 $K^+/K = -2.93V$, $Ag^+/Ag = 0.80V$,
 $Hg^{2+}/Hg = 0.79V$
 $Mg^{2+}/Mg = -2.37 V$, $Cr^{3+}/Cr = -0.74V$
 Arrange these metals in their increasing order of reducing power.
- 3.3** Depict the galvanic cell in which the reaction $Zn(s) + 2Ag^+(aq) \rightarrow Zn^{2+}(aq) + 2Ag(s)$ takes place. Further show:
 (i) Which of the electrode is negatively charged?
 (ii) The carriers of the current in the cell.
 (iii) Individual reaction at each electrode.
- 3.4** Calculate the standard cell potentials of galvanic cell in which the following reactions take place:
 (i) $2Cr(s) + 3Cd^{2+}(aq) \rightarrow 2Cr^{3+}(aq) + 3Cd$
 (ii) $Fe^{2+}(aq) + Ag^+(aq) \rightarrow Fe^{3+}(aq) + Ag(s)$
 Calculate the $\Delta_r G^{\ominus}$ and equilibrium constant of the reactions.
- 3.5** Write the Nernst equation and emf of the following cells at 298 K:
 (i) $Mg(s) | Mg^{2+}(0.001M) || Cu^{2+}(0.0001 M) | Cu(s)$

- (ii) $\text{Fe(s)} | \text{Fe}^{2+}(0.001\text{M}) || \text{H}^+(1\text{M}) | \text{H}_2(\text{g})(1\text{bar}) | \text{Pt(s)}$
 (iii) $\text{Sn(s)} | \text{Sn}^{2+}(0.050\text{ M}) || \text{H}^+(0.020\text{ M}) | \text{H}_2(\text{g}) (1\text{ bar}) | \text{Pt(s)}$
 (iv) $\text{Pt(s)} | \text{Br}_2(\text{l}) | \text{Br}^-(0.010\text{ M}) || \text{H}^+(0.030\text{ M}) | \text{H}_2(\text{g}) (1\text{ bar}) | \text{Pt(s)}$.
- 3.6** In the button cells widely used in watches and other devices the following reaction takes place:
 $\text{Zn(s)} + \text{Ag}_2\text{O(s)} + \text{H}_2\text{O(l)} \rightarrow \text{Zn}^{2+}(\text{aq}) + 2\text{Ag(s)} + 2\text{OH}^-(\text{aq})$
 Determine $\Delta_r G^\ominus$ and E^\ominus for the reaction.
- 3.7** Define conductivity and molar conductivity for the solution of an electrolyte. Discuss their variation with concentration.
- 3.8** The conductivity of 0.20 M solution of KCl at 298 K is 0.0248 S cm^{-1} . Calculate its molar conductivity.
- 3.9** The resistance of a conductivity cell containing 0.001M KCl solution at 298 K is $1500\ \Omega$. What is the cell constant if conductivity of 0.001M KCl solution at 298 K is $0.146 \times 10^{-3}\text{ S cm}^{-1}$.
- 3.10** The conductivity of sodium chloride at 298 K has been determined at different concentrations and the results are given below:
- | Concentration/M | 0.001 | 0.010 | 0.020 | 0.050 | 0.100 |
|--------------------------------------|-------|-------|-------|-------|--------|
| $10^2 \times \kappa/\text{S m}^{-1}$ | 1.237 | 11.85 | 23.15 | 55.53 | 106.74 |
- Calculate A_m for all concentrations and draw a plot between A_m and $c^{1/2}$. Find the value of A_m^0 .
- 3.11** Conductivity of 0.00241 M acetic acid is $7.896 \times 10^{-5}\text{ S cm}^{-1}$. Calculate its molar conductivity and if A_m^0 for acetic acid is $390.5\text{ S cm}^2\text{ mol}^{-1}$, what is its dissociation constant?
- 3.12** How much charge is required for the following reductions:
 (i) 1 mol of Al^{3+} to Al.
 (ii) 1 mol of Cu^{2+} to Cu.
 (iii) 1 mol of MnO_4^- to Mn^{2+} .
- 3.13** How much electricity in terms of Faraday is required to produce
 (i) 20.0 g of Ca from molten CaCl_2 .
 (ii) 40.0 g of Al from molten Al_2O_3 .
- 3.14** How much electricity is required in coulomb for the oxidation of
 (i) 1 mol of H_2O to O_2 .
 (ii) 1 mol of FeO to Fe_2O_3 .
- 3.15** A solution of $\text{Ni}(\text{NO}_3)_2$ is electrolysed between platinum electrodes using a current of 5 amperes for 20 minutes. What mass of Ni is deposited at the cathode?
- 3.16** Three electrolytic cells A,B,C containing solutions of ZnSO_4 , AgNO_3 and CuSO_4 , respectively are connected in series. A steady current of 1.5 amperes was passed through them until 1.45 g of silver deposited at the cathode of cell B. How long did the current flow? What mass of copper and zinc were deposited?
- 3.17** Using the standard electrode potentials given in Table 3.1, predict if the reaction between the following is feasible:
 (i) $\text{Fe}^{3+}(\text{aq})$ and $\text{I}^-(\text{aq})$

- (ii) Ag^+ (aq) and Cu(s)
- (iii) Fe^{3+} (aq) and Br^- (aq)
- (iv) Ag(s) and Fe^{3+} (aq)
- (v) Br_2 (aq) and Fe^{2+} (aq).

- 3.18** Predict the products of electrolysis in each of the following:
- (i) An aqueous solution of AgNO_3 with silver electrodes.
 - (ii) An aqueous solution of AgNO_3 with platinum electrodes.
 - (iii) A dilute solution of H_2SO_4 with platinum electrodes.
 - (iv) An aqueous solution of CuCl_2 with platinum electrodes.

Answers to Some Intext Questions

3.5 $E_{(\text{cell})} = 0.91 \text{ V}$

3.6 $\Delta_r G^\ominus = -45.54 \text{ kJ mol}^{-1}$, $K_c = 9.62 \times 10^7$

3.90. 114, $3.67 \times 10^{-4} \text{ mol L}^{-1}$

Unit

4

Chemical Kinetics

Objectives

After studying this Unit, you will be able to

- define the average and instantaneous rate of a reaction;
- express the rate of a reaction in terms of change in concentration of either of the reactants or products with time;
- distinguish between elementary and complex reactions;
- differentiate between the molecularity and order of a reaction;
- define rate constant;
- discuss the dependence of rate of reactions on concentration, temperature and catalyst;
- derive integrated rate equations for the zero and first order reactions;
- determine the rate constants for zeroth and first order reactions;
- describe collision theory.

Chemical Kinetics helps us to understand how chemical reactions occur.

Chemistry, by its very nature, is concerned with change. Substances with well defined properties are converted by chemical reactions into other substances with different properties. For any chemical reaction, chemists try to find out

- (a) the feasibility of a chemical reaction which can be predicted by thermodynamics (as you know that a reaction with $\Delta G < 0$, at constant temperature and pressure is feasible);
- (b) extent to which a reaction will proceed can be determined from chemical equilibrium;
- (c) speed of a reaction i.e. time taken by a reaction to reach equilibrium.

Along with feasibility and extent, it is equally important to know the rate and the factors controlling the rate of a chemical reaction for its complete understanding. For example, which parameters determine as to how rapidly food gets spoiled? How to design a rapidly setting material for dental filling? Or what controls the rate at which fuel burns in an auto engine? All these questions can be answered by the branch of chemistry, which deals with the study of reaction rates and their mechanisms, called **chemical kinetics**. The word kinetics is derived from the Greek word 'kinesis' meaning movement. Thermodynamics tells only about the feasibility of a reaction whereas chemical kinetics tells about the rate of a reaction. For example, thermodynamic data indicate that diamond shall convert to graphite but in reality the conversion rate is so slow that the change is not perceptible at all. Therefore, most people think

that diamond is forever. Kinetic studies not only help us to determine the speed or rate of a chemical reaction but also describe the conditions by which the reaction rates can be altered. The factors such as concentration, temperature, pressure and catalyst affect the rate of a reaction. At the macroscopic level, we are interested in amounts reacted or formed and the rates of their consumption or formation. At the molecular level, the reaction mechanisms involving orientation and energy of molecules undergoing collisions, are discussed.

In this Unit, we shall be dealing with average and instantaneous rate of reaction and the factors affecting these. Some elementary ideas about the collision theory of reaction rates are also given. However, in order to understand all these, let us first learn about the reaction rate.

4.1 Rate of a Chemical Reaction

Some reactions such as ionic reactions occur very fast, for example, precipitation of silver chloride occurs instantaneously by mixing of aqueous solutions of silver nitrate and sodium chloride. On the other hand, some reactions are very slow, for example, rusting of iron in the presence of air and moisture. Also there are reactions like inversion of cane sugar and hydrolysis of starch, which proceed with a moderate speed. Can you think of more examples from each category?

You must be knowing that speed of an automobile is expressed in terms of change in the position or distance covered by it in a certain period of time. Similarly, the speed of a reaction or the rate of a reaction can be defined as the change in concentration of a reactant or product in unit time. To be more specific, it can be expressed in terms of:

- (i) the rate of decrease in concentration of any one of the reactants, or
- (ii) the rate of increase in concentration of any one of the products.

Consider a hypothetical reaction, assuming that the volume of the system remains constant.



One mole of the reactant R produces one mole of the product P. If $[R]_1$ and $[P]_1$ are the concentrations of R and P respectively at time t_1 and $[R]_2$ and $[P]_2$ are their concentrations at time t_2 then,

$$\begin{aligned}\Delta t &= t_2 - t_1 \\ \Delta[R] &= [R]_2 - [R]_1 \\ \Delta[P] &= [P]_2 - [P]_1\end{aligned}$$

The square brackets in the above expressions are used to express molar concentration.

Rate of disappearance of R

$$= \frac{\text{Decrease in concentration of R}}{\text{Time taken}} = -\frac{\Delta[R]}{\Delta t} \quad (4.1)$$

Rate of appearance of P

$$= \frac{\text{Increase in concentration of P}}{\text{Time taken}} = + \frac{\Delta[P]}{\Delta t} \quad (4.2)$$

Since, $\Delta[R]$ is a negative quantity (as concentration of reactants is decreasing), it is multiplied with -1 to make the rate of the reaction a positive quantity.

Equations (4.1) and (4.2) given above represent the average rate of a reaction, r_{av} .

Average rate depends upon the change in concentration of reactants or products and the time taken for that change to occur (Fig. 4.1).

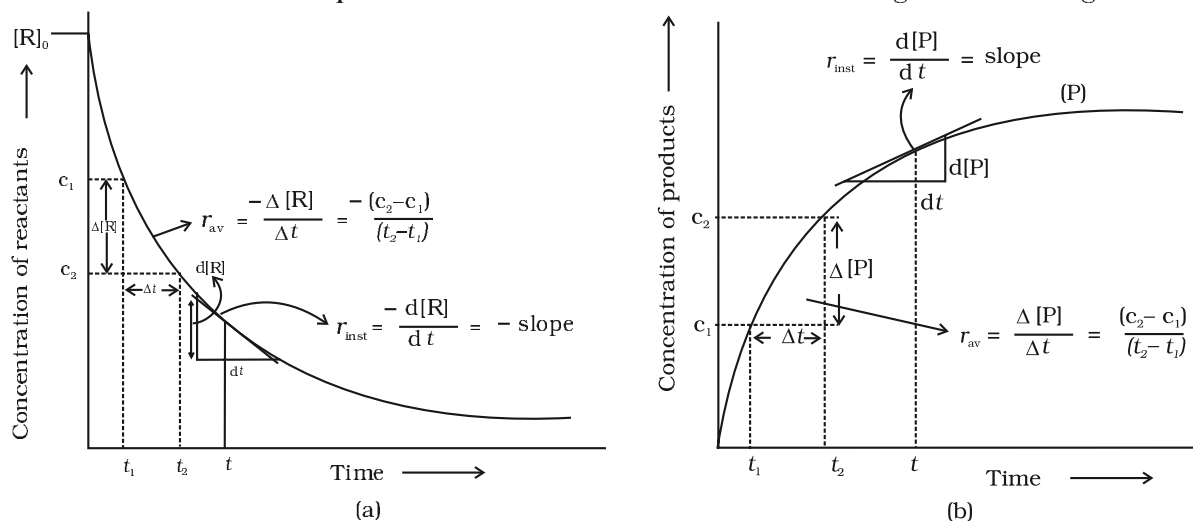
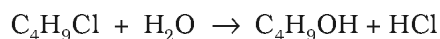

Fig. 4.1: Instantaneous and average rate of a reaction

Units of rate of a reaction

From equations (4.1) and (4.2), it is clear that units of rate are concentration time^{-1} . For example, if concentration is in mol L^{-1} and time is in seconds then the units will be $\text{mol L}^{-1}\text{s}^{-1}$. However, in gaseous reactions, when the concentration of gases is expressed in terms of their partial pressures, then the units of the rate equation will be atm s^{-1} .

From the concentrations of $\text{C}_4\text{H}_9\text{Cl}$ (butyl chloride) at different times given *Example 4.1* below, calculate the average rate of the reaction:



during different intervals of time.

t/s	0	50	100	150	200	300	400	700	800
$[\text{C}_4\text{H}_9\text{Cl}]/\text{mol L}^{-1}$	0.100	0.0905	0.0820	0.0741	0.0671	0.0549	0.0439	0.0210	0.017

We can determine the difference in concentration over different intervals of time and thus determine the average rate by dividing $\Delta[R]$ by Δt (Table 4.1). *Solution*

Table 4.1: Average rates of hydrolysis of butyl chloride

$[\text{C}_4\text{H}_9\text{Cl}]_{t_1} / \text{mol L}^{-1}$	$[\text{C}_4\text{H}_9\text{Cl}]_{t_2} / \text{mol L}^{-1}$	t_1/s	t_2/s	$r_{\text{av}} \times 10^4 / \text{mol L}^{-1}\text{s}^{-1}$ $= -\left\{[\text{C}_4\text{H}_9\text{Cl}]_{t_2} - [\text{C}_4\text{H}_9\text{Cl}]_{t_1} / (t_2 - t_1)\right\} \times 10^4$
0.100	0.0905	0	50	1.90
0.0905	0.0820	50	100	1.70
0.0820	0.0741	100	150	1.58
0.0741	0.0671	150	200	1.40
0.0671	0.0549	200	300	1.22
0.0549	0.0439	300	400	1.10
0.0439	0.0335	400	500	1.04
0.0210	0.017	700	800	0.4

It can be seen (Table 4.1) that the average rate falls from $1.90 \times 10^{-4} \text{ mol L}^{-1}\text{s}^{-1}$ to $0.4 \times 10^{-4} \text{ mol L}^{-1}\text{s}^{-1}$. However, average rate cannot be used to predict the rate of a reaction at a particular instant as it would be constant for the time interval for which it is calculated. So, to express the rate at a particular moment of time we determine the **instantaneous rate**. It is obtained when we consider the average rate at the smallest time interval say dt (i.e. when Δt approaches zero). Hence, mathematically for an infinitesimally small dt instantaneous rate is given by

$$r_{\text{av}} = \frac{-\Delta[\text{R}]}{\Delta t} = \frac{\Delta[\text{P}]}{\Delta t} \quad (4.3)$$

$$\text{As } \Delta t \rightarrow 0 \quad \text{or} \quad r_{\text{inst}} = \frac{-d[\text{R}]}{dt} = \frac{d[\text{P}]}{dt}$$

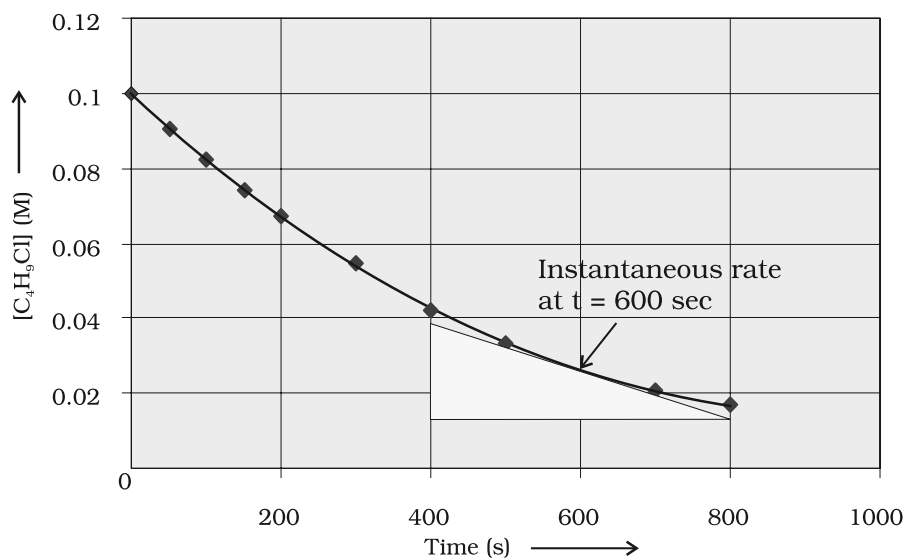

Fig 4.2
Instantaneous rate of hydrolysis of butyl chloride ($\text{C}_4\text{H}_9\text{Cl}$)

It can be determined graphically by drawing a tangent at time t on either of the curves for concentration of R and P vs time t and calculating its slope (Fig. 4.1). So in problem 4.1, r_{inst} at 600s for example, can be calculated by plotting concentration of butyl chloride as a function of time. A tangent is drawn that touches the curve at $t = 600$ s (Fig. 4.2).

The slope of this tangent gives the instantaneous rate.

$$\text{So, } r_{\text{inst}} \text{ at } 600 \text{ s} = \left(\frac{0.0165 - 0.037}{(800 - 400)\text{s}} \right) \text{ mol L}^{-1} = 5.12 \times 10^{-5} \text{ mol L}^{-1}\text{s}^{-1}$$

$$\text{At } t = 250 \text{ s} \quad r_{\text{inst}} = 1.22 \times 10^{-4} \text{ mol L}^{-1}\text{s}^{-1}$$

$$t = 350 \text{ s} \quad r_{\text{inst}} = 1.0 \times 10^{-4} \text{ mol L}^{-1}\text{s}^{-1}$$

$$t = 450 \text{ s} \quad r_{\text{inst}} = 6.4 \times 10^{-5} \text{ mol L}^{-1}\text{s}^{-1}$$

Now consider a reaction

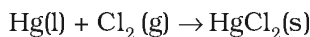

Where stoichiometric coefficients of the reactants and products are same, then rate of the reaction is given as

$$\text{Rate of reaction} = -\frac{\Delta[\text{Hg}]}{\Delta t} = -\frac{\Delta[\text{Cl}_2]}{\Delta t} = \frac{\Delta[\text{HgCl}_2]}{\Delta t}$$

i.e., rate of disappearance of any of the reactants is same as the rate of appearance of the products. But in the following reaction, two moles of HI decompose to produce one mole each of H_2 and I_2 ,

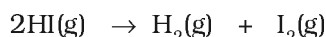

For expressing the rate of such a reaction where stoichiometric coefficients of reactants or products are not equal to one, rate of disappearance of any of the reactants or the rate of appearance of products is divided by their respective stoichiometric coefficients. Since rate of consumption of HI is twice the rate of formation of H_2 or I_2 , to make them equal, the term $\Delta[\text{HI}]$ is divided by 2. The rate of this reaction is given by

$$\text{Rate of reaction} = -\frac{1}{2} \frac{\Delta[\text{HI}]}{\Delta t} = \frac{\Delta[\text{H}_2]}{\Delta t} = \frac{\Delta[\text{I}_2]}{\Delta t}$$

Similarly, for the reaction

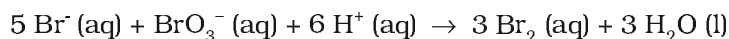

$$\text{Rate} = -\frac{1}{5} \frac{\Delta[\text{Br}^-]}{\Delta t} = -\frac{\Delta[\text{BrO}_3^-]}{\Delta t} = -\frac{1}{6} \frac{\Delta[\text{H}^+]}{\Delta t} = \frac{1}{3} \frac{\Delta[\text{Br}_2]}{\Delta t} = \frac{1}{3} \frac{\Delta[\text{H}_2\text{O}]}{\Delta t}$$

For a gaseous reaction at constant temperature, concentration is directly proportional to the partial pressure of a species and hence, rate can also be expressed as rate of change in partial pressure of the reactant or the product.

Example 4.2 The decomposition of N_2O_5 in CCl_4 at 318K has been studied by monitoring the concentration of N_2O_5 in the solution. Initially the concentration of N_2O_5 is 2.33 mol L^{-1} and after 184 minutes, it is reduced to 2.08 mol L^{-1} . The reaction takes place according to the equation

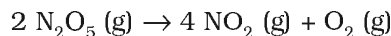

Calculate the average rate of this reaction in terms of hours, minutes and seconds. What is the rate of production of NO_2 during this period?

Solution

$$\begin{aligned} \text{Average Rate} &= \frac{1}{2} \left\{ -\frac{\Delta[\text{N}_2\text{O}_5]}{\Delta t} \right\} = -\frac{1}{2} \left[\frac{(2.08 - 2.33) \text{ mol L}^{-1}}{184 \text{ min}} \right] \\ &= 6.79 \times 10^{-4} \text{ mol L}^{-1} / \text{min} = (6.79 \times 10^{-4} \text{ mol L}^{-1} \text{ min}^{-1}) \times (60 \text{ min} / 1 \text{ h}) \\ &= 4.07 \times 10^{-2} \text{ mol L}^{-1} / \text{h} \\ &= 6.79 \times 10^{-4} \text{ mol L}^{-1} \times 1 \text{ min} / 60 \text{ s} \\ &= 1.13 \times 10^{-5} \text{ mol L}^{-1} \text{ s}^{-1} \end{aligned}$$

It may be remembered that

$$\begin{aligned} \text{Rate} &= \frac{1}{4} \left\{ \frac{\Delta[\text{NO}_2]}{\Delta t} \right\} \\ \frac{\Delta[\text{NO}_2]}{\Delta t} &= 6.79 \times 10^{-4} \times 4 \text{ mol L}^{-1} \text{ min}^{-1} = 2.72 \times 10^{-3} \text{ mol L}^{-1} \text{ min}^{-1} \end{aligned}$$

Intext Questions

- 4.1** For the reaction $\text{R} \rightarrow \text{P}$, the concentration of a reactant changes from 0.03M to 0.02M in 25 minutes. Calculate the average rate of reaction using units of time both in minutes and seconds.
- 4.2** In a reaction, $2\text{A} \rightarrow \text{Products}$, the concentration of A decreases from 0.5 mol L^{-1} to 0.4 mol L^{-1} in 10 minutes. Calculate the rate during this interval?

4.2 Factors Influencing Rate of a Reaction

Rate of reaction depends upon the experimental conditions such as concentration of reactants (pressure in case of gases), temperature and catalyst.

4.2.1 Dependence of Rate on Concentration

The rate of a chemical reaction at a given temperature may depend on the concentration of one or more reactants and products. The representation of rate of reaction in terms of concentration of the reactants is known as **rate law**. It is also called as rate equation or rate expression.

4.2.2 Rate Expression and Rate Constant

The results in Table 4.1 clearly show that rate of a reaction decreases with the passage of time as the concentration of reactants decrease. Conversely, rates generally increase when reactant concentrations increase. So, rate of a reaction depends upon the concentration of reactants.

Consider a general reaction

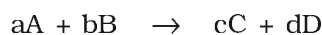

where a, b, c and d are the stoichiometric coefficients of reactants and products.

The rate expression for this reaction is

$$\text{Rate} \propto [A]^x [B]^y \quad (4.4)$$

where exponents x and y may or may not be equal to the stoichiometric coefficients (a and b) of the reactants. Above equation can also be written as

$$\text{Rate} = k [A]^x [B]^y \quad (4.4a)$$

$$-\frac{d[R]}{dt} = k[A]^x [B]^y \quad (4.4b)$$

This form of equation (4.4 b) is known as differential rate equation, where *k* is a proportionality constant called **rate constant**. The equation like (4.4), which relates the rate of a reaction to concentration of reactants is called rate law or rate expression. Thus, **rate law is the expression in which reaction rate is given in terms of molar concentration of reactants with each term raised to some power, which may or may not be same as the stoichiometric coefficient of the reacting species in a balanced chemical equation**. For example:

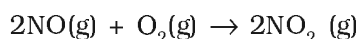

We can measure the rate of this reaction as a function of initial concentrations either by keeping the concentration of one of the reactants constant and changing the concentration of the other reactant or by changing the concentration of both the reactants. The following results are obtained (Table 4.2).

Table 4.2: Initial rate of formation of NO₂

Experiment	Initial [NO]/ mol L ⁻¹	Initial [O ₂]/ mol L ⁻¹	Initial rate of formation of NO ₂ / mol L ⁻¹ s ⁻¹
1.	0.30	0.30	0.096
2.	0.60	0.30	0.384
3.	0.30	0.60	0.192
4.	0.60	0.60	0.768

It is obvious, after looking at the results, that when the concentration of NO is doubled and that of O₂ is kept constant then the initial rate increases by a factor of four from 0.096 to 0.384 mol L⁻¹s⁻¹. This indicates that the rate depends upon the square of the concentration of NO. When concentration of NO is kept constant and concentration of O₂ is doubled the rate also gets doubled indicating that rate depends on concentration of O₂ to the first power. Hence, the rate equation for this reaction will be

$$\text{Rate} = k[\text{NO}]^2[\text{O}_2]$$

The differential form of this rate expression is given as

$$-\frac{d[R]}{dt} = k[\text{NO}]^2 [\text{O}_2]$$

Now, we observe that for this reaction in the rate equation derived from the experimental data, the exponents of the concentration terms are the same as their stoichiometric coefficients in the balanced chemical equation.

Some other examples are given below:

Reaction	Experimental rate expression
1. $\text{CHCl}_3 + \text{Cl}_2 \rightarrow \text{CCl}_4 + \text{HCl}$	$\text{Rate} = k [\text{CHCl}_3] [\text{Cl}_2]^{1/2}$
2. $\text{CH}_3\text{COOC}_2\text{H}_5 + \text{H}_2\text{O} \rightarrow \text{CH}_3\text{COOH} + \text{C}_2\text{H}_5\text{OH}$	$\text{Rate} = k [\text{CH}_3\text{COOC}_2\text{H}_5]^1 [\text{H}_2\text{O}]^0$

In these reactions, the exponents of the concentration terms are not the same as their stoichiometric coefficients. Thus, we can say that:

Rate law for any reaction cannot be predicted by merely looking at the balanced chemical equation, i.e., theoretically but must be determined experimentally.

4.2.3 Order of a Reaction

In the rate equation (4.4)

$$\text{Rate} = k [\text{A}]^x [\text{B}]^y$$

x and y indicate how sensitive the rate is to the change in concentration of A and B. Sum of these exponents, i.e., x + y in (4.4) gives the overall order of a reaction whereas x and y represent the order with respect to the reactants A and B respectively.

Hence, **the sum of powers of the concentration of the reactants in the rate law expression is called the order of that chemical reaction.**

Order of a reaction can be 0, 1, 2, 3 and even a fraction. A zero order reaction means that the rate of reaction is independent of the concentration of reactants.

Example 4.3 Calculate the overall order of a reaction which has the rate expression

(a) $\text{Rate} = k [\text{A}]^{1/2} [\text{B}]^{3/2}$

(b) $\text{Rate} = k [\text{A}]^{3/2} [\text{B}]^{-1}$

Solution

(a) $\text{Rate} = k [\text{A}]^x [\text{B}]^y$

$$\text{order} = x + y$$

$$\text{So order} = 1/2 + 3/2 = 2, \text{ i.e., second order}$$

(b) $\text{order} = 3/2 + (-1) = 1/2, \text{ i.e., half order.}$

A balanced chemical equation never gives us a true picture of how a reaction takes place since rarely a reaction gets completed in one step. The reactions taking place in one step are called **elementary reactions**. When a sequence of elementary reactions (called mechanism) gives us the products, the reactions are called **complex reactions**.

These may be consecutive reactions (e.g., oxidation of ethane to CO₂ and H₂O passes through a series of intermediate steps in which alcohol, aldehyde and acid are formed), reverse reactions and side reactions (e.g., nitration of phenol yields *o*-nitrophenol and *p*-nitrophenol).

Units of rate constant

For a general reaction

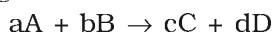

$$\text{Rate} = k [A]^x [B]^y$$

Where $x + y = n = \text{order of the reaction}$

$$k = \frac{\text{Rate}}{[A]^x [B]^y}$$

$$= \frac{\text{concentration}}{\text{time}} \times \frac{1}{(\text{concentration})^n}$$

Taking SI units of concentration, mol L⁻¹ and time, s, the units of k for different reaction order are listed in Table 4.3

Table 4.3: Units of rate constant

Reaction	Order	Units of rate constant
Zero order reaction	0	$\frac{\text{mol L}^{-1}}{\text{s}} \times \frac{1}{(\text{mol L}^{-1})^0} = \text{mol L}^{-1} \text{s}^{-1}$
First order reaction	1	$\frac{\text{mol L}^{-1}}{\text{s}} \times \frac{1}{(\text{mol L}^{-1})^1} = \text{s}^{-1}$
Second order reaction	2	$\frac{\text{mol L}^{-1}}{\text{s}} \times \frac{1}{(\text{mol L}^{-1})^2} = \text{mol}^{-1} \text{L s}^{-1}$

Identify the reaction order from each of the following rate constants. *Example 4.4*

(i) $k = 2.3 \times 10^{-5} \text{ L mol}^{-1} \text{ s}^{-1}$

(ii) $k = 3 \times 10^{-4} \text{ s}^{-1}$

(i) The unit of second order rate constant is L mol⁻¹ s⁻¹, therefore *Solution*
 $k = 2.3 \times 10^{-5} \text{ L mol}^{-1} \text{ s}^{-1}$ represents a second order reaction.

(ii) The unit of a first order rate constant is s⁻¹ therefore
 $k = 3 \times 10^{-4} \text{ s}^{-1}$ represents a first order reaction.

4.2.4 Molecularity of a Reaction

Another property of a reaction called molecularity helps in understanding its mechanism. **The number of reacting species (atoms, ions or molecules) taking part in an elementary reaction, which must collide simultaneously in order to bring about a chemical reaction is called molecularity of a reaction.** The reaction can be unimolecular when one reacting species is involved, for example, decomposition of ammonium nitrite.

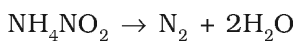

Bimolecular reactions involve simultaneous collision between two species, for example, dissociation of hydrogen iodide.

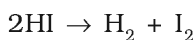

Trimolecular or termolecular reactions involve simultaneous collision between three reacting species, for example,

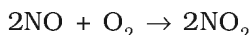

The probability that more than three molecules can collide and react simultaneously is very small. Hence, the molecularity greater than three is not observed.

It is, therefore, evident that complex reactions involving more than three molecules in the stoichiometric equation must take place in more than one step.

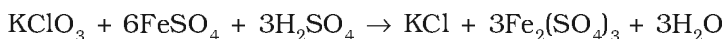

This reaction which apparently seems to be of tenth order is actually a second order reaction. This shows that this reaction takes place in several steps. Which step controls the rate of the overall reaction? The question can be answered if we go through the mechanism of reaction, for example, chances to win the relay race competition by a team depend upon the slowest person in the team. Similarly, the overall rate of the reaction is controlled by the slowest step in a reaction called the **rate determining step**. Consider the decomposition of hydrogen peroxide which is catalysed by iodide ion in an alkaline medium.

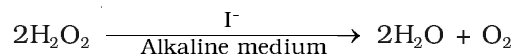

The rate equation for this reaction is found to be

$$\text{Rate} = \frac{-d[\text{H}_2\text{O}_2]}{dt} = k[\text{H}_2\text{O}_2][\text{I}^-]$$

This reaction is first order with respect to both H_2O_2 and I^- . Evidences suggest that this reaction takes place in two steps

- (1) $\text{H}_2\text{O}_2 + \text{I}^- \rightarrow \text{H}_2\text{O} + \text{IO}^-$
- (2) $\text{H}_2\text{O}_2 + \text{IO}^- \rightarrow \text{H}_2\text{O} + \text{I}^- + \text{O}_2$

Both the steps are bimolecular elementary reactions. Species IO^- is called as an intermediate since it is formed during the course of the reaction but not in the overall balanced equation. The first step, being slow, is the rate determining step. Thus, the rate of formation of intermediate will determine the rate of this reaction.

Thus, from the discussion, till now, we conclude the following:

- (i) Order of a reaction is an experimental quantity. It can be zero and even a fraction but molecularity cannot be zero or a non integer.
- (ii) Order is applicable to elementary as well as complex reactions whereas molecularity is applicable only for elementary reactions. For complex reaction molecularity has no meaning.

- (iii) For complex reaction, order is given by the slowest step and generally, molecularity of the slowest step is same as the order of the overall reaction.

Intext Questions

- 4.3** For a reaction, $A + B \rightarrow \text{Product}$; the rate law is given by, $r = k[A]^{1/2}[B]^2$. What is the order of the reaction?
- 4.4** The conversion of molecules X to Y follows second order kinetics. If concentration of X is increased to three times how will it affect the rate of formation of Y?

4.3 Integrated Rate Equations

We have already noted that the concentration dependence of rate is called differential rate equation. It is not always convenient to determine the instantaneous rate, as it is measured by determination of slope of the tangent at point 't' in concentration vs time plot (Fig. 4.1). This makes it difficult to determine the rate law and hence the order of the reaction. In order to avoid this difficulty, we can integrate the differential rate equation to give a relation between directly measured experimental data, i.e., concentrations at different times and rate constant.

The integrated rate equations are different for the reactions of different reaction orders. We shall determine these equations only for zero and first order chemical reactions.

4.3.1 Zero Order Reactions

Zero order reaction means that the rate of the reaction is proportional to zero power of the concentration of reactants. Consider the reaction,

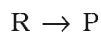

$$\text{Rate} = -\frac{d[R]}{dt} = k[R]^0$$

As any quantity raised to power zero is unity

$$\text{Rate} = -\frac{d[R]}{dt} = k \times 1$$

$$d[R] = -k dt$$

Integrating both sides

$$[R] = -k t + I \quad (4.5)$$

where, I is the constant of integration.

At $t = 0$, the concentration of the reactant $R = [R]_0$, where $[R]_0$ is initial concentration of the reactant.

Substituting in equation (4.5)

$$[R]_0 = -k \times 0 + I$$

$$[R]_0 = I$$

Substituting the value of I in the equation (4.5)

$$[R] = -kt + [R]_0 \quad (4.6)$$

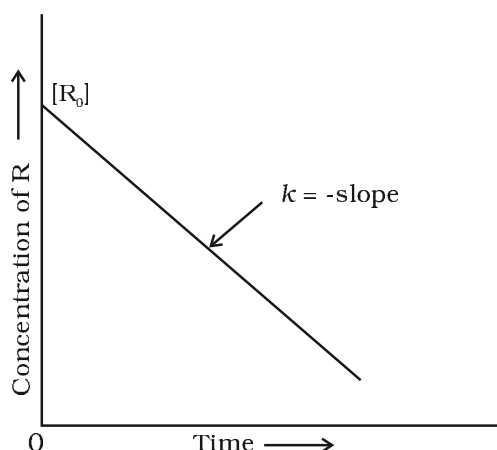

Fig. 4.3: Variation in the concentration vs time plot for a zero order reaction

Comparing (4.6) with equation of a straight line, $y = mx + c$, if we plot $[R]$ against t , we get a straight line (Fig. 4.3) with slope = $-k$ and intercept equal to $[R]_0$.

Further simplifying equation (4.6), we get the rate constant, k as

$$k = \frac{[R]_0 - [R]}{t} \quad (4.7)$$

Zero order reactions are relatively uncommon but they occur under special conditions. Some enzyme catalysed reactions and reactions which occur on metal surfaces are a few examples of zero order reactions. The decomposition of gaseous ammonia on a hot platinum surface is a zero order reaction at high pressure.

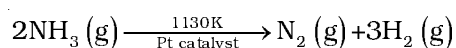

$$\text{Rate} = k [\text{NH}_3]^0 = k$$

In this reaction, platinum metal acts as a catalyst. At high pressure, the metal surface gets saturated with gas molecules. So, a further change in reaction conditions is unable to alter the amount of ammonia on the surface of the catalyst making rate of the reaction independent of its concentration. The thermal decomposition of HI on gold surface is another example of zero order reaction.

4.3.2 First Order Reactions

In this class of reactions, the rate of the reaction is proportional to the first power of the concentration of the reactant R . For example,



$$\text{Rate} = -\frac{d[R]}{dt} = k[R]$$

$$\text{or } \frac{d[R]}{[R]} = -kdt$$

Integrating this equation, we get

$$\ln [R] = -kt + I \quad (4.8)$$

Again, I is the constant of integration and its value can be determined easily.

When $t = 0$, $R = [R]_0$, where $[R]_0$ is the initial concentration of the reactant.

Therefore, equation (4.8) can be written as

$$\ln [R]_0 = -k \times 0 + I$$

$$\ln [R]_0 = I$$

Substituting the value of I in equation (4.8)

$$\ln [R] = -kt + \ln [R]_0 \quad (4.9)$$

Rearranging this equation

$$\ln \frac{[R]}{[R]_0} = -kt$$

or $k = \frac{1}{t} \ln \frac{[R]_0}{[R]}$ (4.10)

At time t_1 from equation (4.8)

$$*\ln[R]_1 = -kt_1 + *\ln[R]_0$$
 (4.11)

At time t_2

$$\ln[R]_2 = -kt_2 + \ln[R]_0$$
 (4.12)

where, $[R]_1$ and $[R]_2$ are the concentrations of the reactants at time t_1 and t_2 respectively.

Subtracting (4.12) from (4.11)

$$\ln[R]_1 - \ln[R]_2 = -kt_1 - (-kt_2)$$
$$\ln \frac{[R]_1}{[R]_2} = k(t_2 - t_1)$$
$$k = \frac{1}{(t_2 - t_1)} \ln \frac{[R]_1}{[R]_2}$$
 (4.13)

Equation (4.9) can also be written as

$$\ln \frac{[R]}{[R]_0} = -kt$$

Taking antilog of both sides

$$[R] = [R]_0 e^{-kt}$$
 (4.14)

Comparing equation (4.9) with $y = mx + c$, if we plot $\ln [R]$ against t (Fig. 4.4) we get a straight line with slope = $-k$ and intercept equal to $\ln [R]_0$

The first order rate equation (4.10) can also be written in the form

$$k = \frac{2.303}{t} \log \frac{[R]_0}{[R]}$$
 (4.15)
$$*\log \frac{[R]_0}{[R]} = \frac{kt}{2.303}$$

If we plot a graph between $\log [R]_0/[R]$ vs t , (Fig. 4.5), the slope = $k/2.303$

Hydrogenation of ethene is an example of first order reaction.

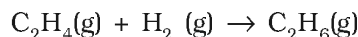

$$\text{Rate} = k [C_2H_4]$$

All natural and artificial radioactive decay of unstable nuclei take place by first order kinetics.

* Refer to Appendix-IV for \ln and \log (logarithms).

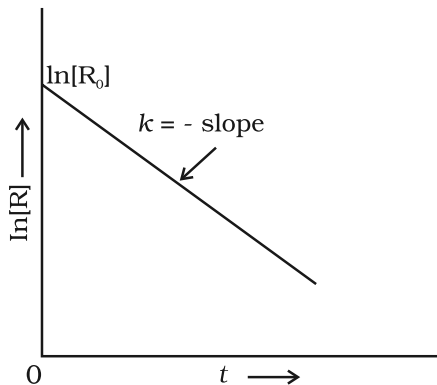

Fig. 4.4: A plot between $\ln[R]$ and t for a first order reaction

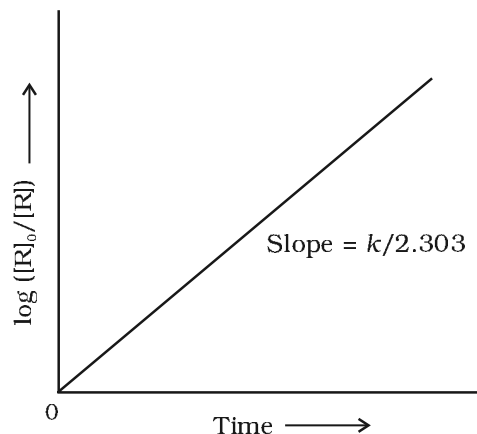
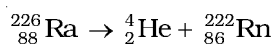

Fig. 4.5: Plot of $\log [R]_0/[R]$ vs time for a first order reaction



$$\text{Rate} = k [\text{Ra}]$$

Decomposition of N_2O_5 and N_2O are some more examples of first order reactions.

Example 4.5 The initial concentration of N_2O_5 in the following first order reaction $\text{N}_2\text{O}_5(\text{g}) \rightarrow 2 \text{NO}_2(\text{g}) + 1/2 \text{O}_2(\text{g})$ was $1.24 \times 10^{-2} \text{ mol L}^{-1}$ at 318 K. The concentration of N_2O_5 after 60 minutes was $0.20 \times 10^{-2} \text{ mol L}^{-1}$. Calculate the rate constant of the reaction at 318 K.

Solution For a first order reaction

$$\begin{aligned} \log \frac{[R]_1}{[R]_2} &= \frac{k(t_2 - t_1)}{2.303} \\ k &= \frac{2.303}{(t_2 - t_1)} \log \frac{[R]_1}{[R]_2} \\ &= \frac{2.303}{(60 \text{ min} - 0 \text{ min})} \log \frac{1.24 \times 10^{-2} \text{ mol L}^{-1}}{0.20 \times 10^{-2} \text{ mol L}^{-1}} \\ &= \frac{2.303}{60} \log 6.2 \text{ min}^{-1} \\ k &= 0.0304 \text{ min}^{-1} \end{aligned}$$

Let us consider a typical first order gas phase reaction

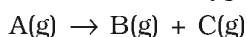

Let p_i be the initial pressure of A and p_t the total pressure at time ' t '. Integrated rate equation for such a reaction can be derived as

$$\text{Total pressure } p_t = p_A + p_B + p_C \text{ (pressure units)}$$

p_A , p_B and p_C are the partial pressures of A, B and C, respectively.
 If x atm be the decrease in pressure of A at time t and one mole each of B and C is being formed, the increase in pressure of B and C will also be x atm each.

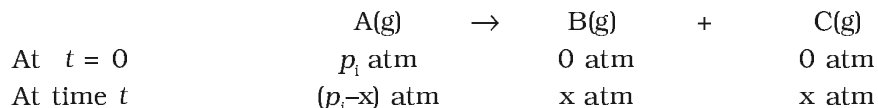

where, p_i is the initial pressure at time $t = 0$.

$$p_t = (p_i - x) + x + x = p_i + x$$

$$x = (p_t - p_i)$$

where, $p_A = p_i - x = p_i - (p_t - p_i)$

$$= 2p_i - p_t$$

$$k = \left(\frac{2.303}{t} \right) \left(\log \frac{p_i}{p_A} \right) \quad (4.16)$$

$$= \frac{2.303}{t} \log \frac{p_i}{(2p_i - p_t)}$$

The following data were obtained during the first order thermal decomposition of N_2O_5 (g) at constant volume:

Example 4.6

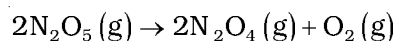

S.No.	Time/s	Total Pressure/(atm)
1.	0	0.5
2.	100	0.512

Calculate the rate constant.

Let the pressure of N_2O_5 (g) decrease by $2x$ atm. As two moles of N_2O_5 decompose to give two moles of N_2O_4 (g) and one mole of O_2 (g), the pressure of N_2O_4 (g) increases by $2x$ atm and that of O_2 (g) increases by x atm.

Solution

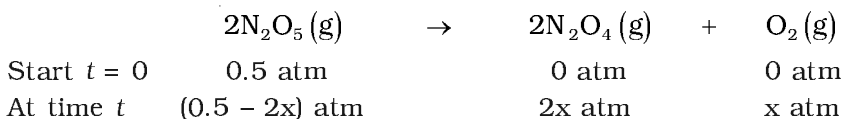

$$p_t = p_{N_2O_5} + p_{N_2O_4} + p_{O_2}$$

$$= (0.5 - 2x) + 2x + x = 0.5 + x$$

$$x = p_t - 0.5$$

$$p_{N_2O_5} = 0.5 - 2x$$

$$= 0.5 - 2(p_t - 0.5) = 1.5 - 2p_t$$

At $t = 100$ s; $p_t = 0.512$ atm

$$p_{\text{N}_2\text{O}_5} = 1.5 - 2 \times 0.512 = 0.476 \text{ atm}$$

Using equation (4.16)

$$k = \frac{2.303}{t} \log \frac{p_i}{p_A} = \frac{2.303}{100 \text{ s}} \log \frac{0.5 \text{ atm}}{0.476 \text{ atm}}$$

$$= \frac{2.303}{100 \text{ s}} \times 0.0216 = 4.98 \times 10^{-4} \text{ s}^{-1}$$

4.3.3 Half-Life of a Reaction

The half-life of a reaction is the time in which the concentration of a reactant is reduced to one half of its initial concentration. It is represented as $t_{1/2}$.

For a zero order reaction, rate constant is given by equation 4.7.

$$k = \frac{[\text{R}]_0 - [\text{R}]}{t}$$

$$\text{At } t = t_{1/2}, [\text{R}] = \frac{1}{2}[\text{R}]_0$$

The rate constant at $t_{1/2}$ becomes

$$k = \frac{[\text{R}]_0 - 1/2[\text{R}]_0}{t_{1/2}}$$

$$t_{1/2} = \frac{[\text{R}]_0}{2k}$$

It is clear that $t_{1/2}$ for a zero order reaction is directly proportional to the initial concentration of the reactants and inversely proportional to the rate constant.

For the first order reaction,

$$k = \frac{2.303}{t} \log \frac{[\text{R}]_0}{[\text{R}]} \quad (4.15)$$

$$\text{at } t_{1/2} \quad [\text{R}] = \frac{[\text{R}]_0}{2} \quad (4.16)$$

So, the above equation becomes

$$k = \frac{2.303}{t_{1/2}} \log \frac{[\text{R}]_0}{[\text{R}]/2}$$

$$\text{or } t_{1/2} = \frac{2.303}{k} \log 2$$

$$t_{1/2} = \frac{2.303}{k} \times 0.301$$

$$t_{1/2} = \frac{0.693}{k} \quad (4.17)$$

It can be seen that for a first order reaction, half-life period is constant, i.e., it is independent of initial concentration of the reacting species. The half-life of a first order equation is readily calculated from the rate constant and vice versa.

For zero order reaction $t_{1/2} \propto [R]_0$. For first order reaction $t_{1/2}$ is independent of $[R]_0$.

A first order reaction is found to have a rate constant, $k = 5.5 \times 10^{-14} \text{ s}^{-1}$. *Example 4.7*
Find the half-life of the reaction.

Half-life for a first order reaction is

$$t_{1/2} = \frac{0.693}{k}$$

$$t_{1/2} = \frac{0.693}{5.5 \times 10^{-14} \text{ s}^{-1}} = 1.26 \times 10^{14} \text{ s}$$

Solution

Show that in a first order reaction, time required for completion of 99.9% is 10 times of half-life ($t_{1/2}$) of the reaction.

When reaction is completed 99.9%, $[R]_n = [R]_0 - 0.999[R]_0$

Example 4.8

$$k = \frac{2.303}{t} \log \frac{[R]_0}{[R]}$$

$$= \frac{2.303}{t} \log \frac{[R]_0}{[R]_0 - 0.999[R]_0} = \frac{2.303}{t} \log 10^3$$

$$t = 6.909/k$$

Solution

For half-life of the reaction

$$t_{1/2} = 0.693/k$$

$$\frac{t}{t_{1/2}} = \frac{6.909}{k} \times \frac{k}{0.693} = 10$$

Table 4.4 summarises the mathematical features of integrated laws of zero and first order reactions.

Table 4.4: Integrated Rate Laws for the Reactions of Zero and First Order

Order	Reaction type	Differential rate law	Integrated rate law	Straight line plot	Half-life	Units of k
0	R → P	$d[R]/dt = -k$	$kt = [R]_0 - [R]$	[R] vs t	$[R]_0/2k$	conc time^{-1} or $\text{mol L}^{-1}\text{s}^{-1}$
1	R → P	$d[R]/dt = -k[R]$	$[R] = [R]_0 e^{-kt}$ or $kt = \ln\{[R]_0/[R]\}$	$\ln[R]$ vs t	$\ln 2/k$	time^{-1} or s^{-1}

From the above data we note

t/min	$C/\text{mol L}^{-1}$	$k/\text{mol L}^{-1}$
0	0.8500	—
30	0.8004	2.004×10^{-3}
60	0.7538	2.002×10^{-3}
90	0.7096	2.005×10^{-3}

It can be seen that $k[\text{H}_2\text{O}]$ is constant and equal to $2.004 \times 10^{-3} \text{ min}^{-1}$ and hence, it is pseudo first order reaction. We can now determine k from

$$k[\text{H}_2\text{O}] = 2.004 \times 10^{-3} \text{ min}^{-1}$$

$$k[55 \text{ mol L}^{-1}] = 2.004 \times 10^{-3} \text{ min}^{-1}$$

$$k = 3.64 \times 10^{-5} \text{ mol}^{-1} \text{ L min}^{-1}$$

Intext Questions

- 4.5** A first order reaction has a rate constant $1.15 \times 10^{-3} \text{ s}^{-1}$. How long will 5 g of this reactant take to reduce to 3 g?
- 4.6** Time required to decompose SO_2Cl_2 to half of its initial amount is 60 minutes. If the decomposition is a first order reaction, calculate the rate constant of the reaction.

4.5 *Temperature Dependence of the Rate of a Reaction*

Most of the chemical reactions are accelerated by increase in temperature. For example, in decomposition of N_2O_5 , the time taken for half of the original amount of material to decompose is 12 min at 50°C , 5 h at 25°C and 10 days at 0°C . You also know that in a mixture of potassium permanganate (KMnO_4) and oxalic acid ($\text{H}_2\text{C}_2\text{O}_4$), potassium permanganate gets decolourised faster at a higher temperature than that at a lower temperature.

It has been found that **for a chemical reaction with rise in temperature by 10° , the rate constant is nearly doubled.**

The temperature dependence of the rate of a chemical reaction can be accurately explained by Arrhenius equation (4.18). It was first proposed by Dutch chemist, J.H. van't Hoff but Swedish chemist, Arrhenius provided its physical justification and interpretation.

$$k = A e^{-E_a/RT} \quad (4.18)$$

where A is the Arrhenius factor or the frequency factor. It is also called pre-exponential factor. It is a constant specific to a particular reaction. R is gas constant and E_a is activation energy measured in joules/mole (J mol^{-1}).

It can be understood clearly using the following simple reaction

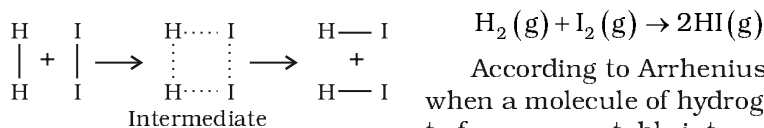

Fig. 4.6: Formation of HI through the intermediate

According to Arrhenius, this reaction can take place only when a molecule of hydrogen and a molecule of iodine collide to form an unstable intermediate (Fig. 4.6). It exists for a very short time and then breaks up to form two molecules of hydrogen iodide.

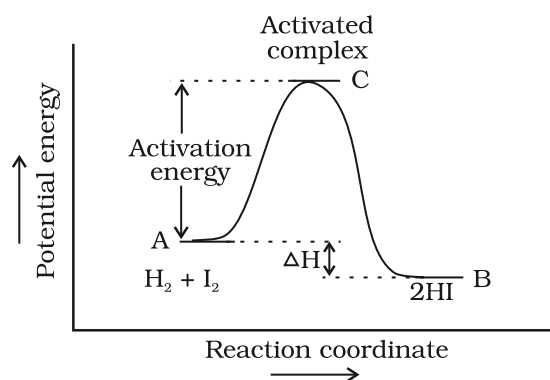

Fig. 4.7: Diagram showing plot of potential energy vs reaction coordinate.

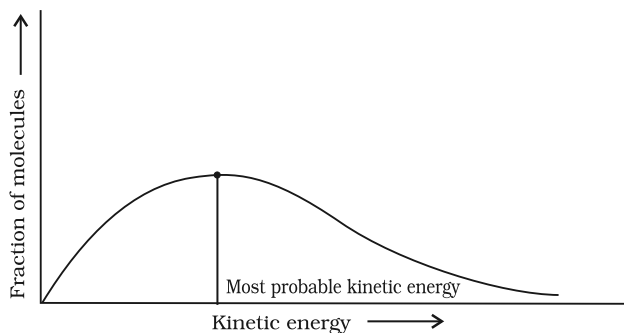

Fig. 4.8: Distribution curve showing energies among gaseous molecules

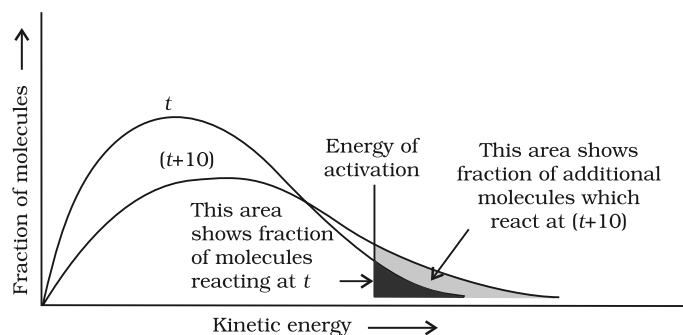

Fig. 4.9: Distribution curve showing temperature dependence of rate of a reaction

The energy required to form this intermediate, called **activated complex (C)**, is known as **activation energy (E_a)**. Fig. 4.7 is obtained by plotting potential energy vs reaction coordinate. Reaction coordinate represents the profile of energy change when reactants change into products.

Some energy is released when the complex decomposes to form products. So, the final heat of the reaction depends upon the nature of reactants and products.

All the molecules in the reacting species do not have the same kinetic energy. Since it is difficult to predict the behaviour of any one molecule with precision, Ludwig Boltzmann and James Clark Maxwell used statistics to predict the behaviour of large number of molecules. According to them, the distribution of kinetic energy may be described by plotting the fraction of molecules (N_E/N_T) with a given kinetic energy (E) vs kinetic energy (Fig. 4.8). Here, N_E is the number of molecules with energy E and N_T is total number of molecules.

The peak of the curve corresponds to the **most probable kinetic energy**, i.e., kinetic energy of maximum fraction of molecules. There are decreasing number of molecules with energies higher or lower than this value. When the temperature is raised, the maximum of the curve moves to the higher energy value (Fig. 4.9) and the curve broadens out, i.e., spreads to the right such that there is a greater

proportion of molecules with much higher energies. The area under the curve must be constant since total probability must be one at all times. We can mark the position of E_a on Maxwell Boltzmann distribution curve (Fig. 4.9).

Increasing the temperature of the substance increases the fraction of molecules, which collide with energies greater than E_a . It is clear from the diagram that in the curve at $(t + 10)$, the area showing the fraction of molecules having energy equal to or greater than activation energy gets doubled leading to doubling the rate of a reaction.

In the Arrhenius equation (4.18) the factor $e^{-E_a/RT}$ corresponds to the fraction of molecules that have kinetic energy greater than E_a . Taking natural logarithm of both sides of equation (4.18)

$$\ln k = -\frac{E_a}{RT} + \ln A \quad (4.19)$$

The plot of $\ln k$ vs $1/T$ gives a straight line according to the equation (4.19) as shown in Fig. 4.10.

Thus, it has been found from Arrhenius equation (4.18) that increasing the temperature or decreasing the activation energy will result in an increase in the rate of the reaction and an exponential increase in the rate constant.

In Fig. 4.10, slope = $-\frac{E_a}{R}$ and intercept = $\ln A$. So we can calculate E_a and A using these values.

At temperature T_1 , equation (4.19) is

$$\ln k_1 = -\frac{E_a}{RT_1} + \ln A \quad (4.20)$$

At temperature T_2 , equation (4.19) is

$$\ln k_2 = -\frac{E_a}{RT_2} + \ln A \quad (4.21)$$

(since A is constant for a given reaction)

k_1 and k_2 are the values of rate constants at temperatures T_1 and T_2 respectively.

Subtracting equation (4.20) from (4.21), we obtain

$$\begin{aligned} \ln k_2 - \ln k_1 &= \frac{E_a}{RT_1} - \frac{E_a}{RT_2} \\ \ln \frac{k_2}{k_1} &= \frac{E_a}{R} \left[\frac{1}{T_1} - \frac{1}{T_2} \right] \\ \log \frac{k_2}{k_1} &= \frac{E_a}{2.303R} \left[\frac{1}{T_1} - \frac{1}{T_2} \right] \end{aligned} \quad (4.22)$$

$$\log \frac{k_2}{k_1} = \frac{E_a}{2.303R} \left[\frac{T_2 - T_1}{T_1 T_2} \right]$$

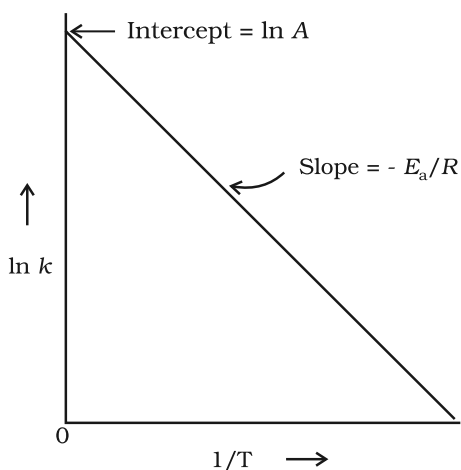

Fig. 4.10: A plot between $\ln k$ and $1/T$

Example 4.10 The rate constants of a reaction at 500K and 700K are 0.02s^{-1} and 0.07s^{-1} respectively. Calculate the values of E_a and A .

Solution

$$\log \frac{k_2}{k_1} = \frac{E_a}{2.303R} \left[\frac{T_2 - T_1}{T_1 T_2} \right]$$

$$\log \frac{0.07}{0.02} = \left(\frac{E_a}{2.303 \times 8.314 \text{ JK}^{-1} \text{ mol}^{-1}} \right) \left[\frac{700 - 500}{700 \times 500} \right]$$

$$0.544 = E_a \times 5.714 \times 10^{-4} / 19.15$$

$$E_a = 0.544 \times 19.15 / 5.714 \times 10^{-4} = 18230.8 \text{ J}$$

Since $k = Ae^{-E_a/RT}$

$$0.02 = Ae^{-18230.8/8.314 \times 500}$$

$$A = 0.02/0.012 = 1.61$$

Example 4.11 The first order rate constant for the decomposition of ethyl iodide by the reaction

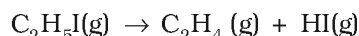

at 600K is $1.60 \times 10^{-5} \text{ s}^{-1}$. Its energy of activation is 209 kJ/mol. Calculate the rate constant of the reaction at 700K.

Solution We know that

$$\log k_2 - \log k_1 = \frac{E_a}{2.303R} \left[\frac{1}{T_1} - \frac{1}{T_2} \right]$$

$$\log k_2 = \log k_1 + \frac{E_a}{2.303R} \left[\frac{1}{T_1} - \frac{1}{T_2} \right]$$

$$= \log(1.60 \times 10^{-5}) + \frac{209000 \text{ J mol}^{-1}}{2.303 \times 8.314 \text{ J mol}^{-1} \text{ K}^{-1}} \left[\frac{1}{600\text{K}} - \frac{1}{700\text{K}} \right]$$

$$\log k_2 = -4.796 + 2.599 = -2.197$$

$$k_2 = 6.36 \times 10^{-3} \text{ s}^{-1}$$

4.5.1 Effect of Catalyst

A catalyst is a substance which alters the rate of a reaction without itself undergoing any permanent chemical change. For example, MnO_2 catalyses the following reaction so as to increase its rate considerably.

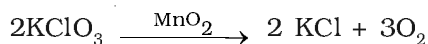

The action of the catalyst can be explained by intermediate complex theory. According to this theory, a catalyst participates in a chemical reaction by forming temporary bonds with the reactants resulting in an intermediate complex. This has a transitory existence and decomposes to yield products and the catalyst.

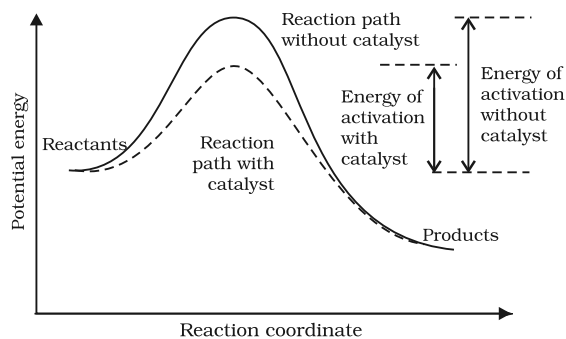

Fig. 4.11: Effect of catalyst on activation energy

It is believed that the catalyst provides an alternate pathway or reaction mechanism by reducing the activation energy between reactants and products and hence lowering the potential energy barrier as shown in Fig. 4.11.

It is clear from Arrhenius equation (4.18) that lower the value of activation energy faster will be the rate of a reaction.

A small amount of the catalyst can catalyse a large amount of reactants. A catalyst does not alter Gibbs energy, ΔG of a reaction. It catalyses the spontaneous reactions but does

not catalyse non-spontaneous reactions. It is also found that a catalyst does not change the equilibrium constant of a reaction rather, it helps in attaining the equilibrium faster, that is, it catalyses the forward as well as the backward reactions to the same extent so that the equilibrium state remains same but is reached earlier.

4.6 Collision Theory of Chemical Reactions

Though Arrhenius equation is applicable under a wide range of circumstances, collision theory, which was developed by Max Trautz and William Lewis in 1916-18, provides a greater insight into the energetic and mechanistic aspects of reactions. It is based on kinetic theory of gases. According to this theory, the reactant molecules are assumed to be hard spheres and reaction is postulated to occur when molecules collide with each other. **The number of collisions per second per unit volume of the reaction mixture is known as collision frequency (Z).** Another factor which affects the rate of chemical reactions is activation energy (as we have already studied). For a bimolecular elementary reaction

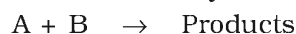

rate of reaction can be expressed as

$$\text{Rate} = Z_{AB} e^{-E_a/RT} \quad (4.23)$$

where Z_{AB} represents the collision frequency of reactants, A and B and $e^{-E_a/RT}$ represents the fraction of molecules with energies equal to or greater than E_a . Comparing (4.23) with Arrhenius equation, we can say that A is related to collision frequency.

Equation (4.23) predicts the value of rate constants fairly accurately for the reactions that involve atomic species or simple molecules but for complex molecules significant deviations are observed. The reason could be that all collisions do not lead to the formation of products. The collisions in which molecules collide with sufficient kinetic energy (called threshold energy*) and proper orientation, so as to facilitate breaking of bonds between reacting species and formation of new bonds to form products are called as **effective collisions**.

* Threshold energy = Activation Energy + energy possessed by reacting species.

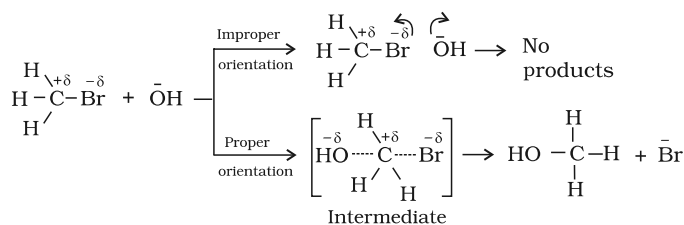
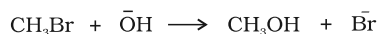

Fig. 4.12: Diagram showing molecules having proper and improper orientation

For example, formation of methanol from bromoethane depends upon the orientation of reactant molecules as shown in Fig. 4.12. *The proper orientation of reactant molecules lead to bond formation whereas improper orientation makes them simply bounce back and no products are formed.*

To account for effective collisions, another factor P , called the probability or steric factor is introduced. It takes into account the fact that in a collision, molecules must be properly oriented i.e.,

$$\text{Rate} = PZ_{\text{AB}}e^{-E_a/RT}$$

Thus, in collision theory activation energy and proper orientation of the molecules together determine the criteria for an effective collision and hence the rate of a chemical reaction.

Collision theory also has certain drawbacks as it considers atoms/molecules to be hard spheres and ignores their structural aspect. You will study details about this theory and more on other theories in your higher classes.

Intext Questions

- 4.7** What will be the effect of temperature on rate constant ?
- 4.8** The rate of the chemical reaction doubles for an increase of 10K in absolute temperature from 298K. Calculate E_a .
- 4.9** The activation energy for the reaction

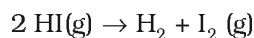

is $209.5 \text{ kJ mol}^{-1}$ at 581K. Calculate the fraction of molecules of reactants having energy equal to or greater than activation energy?

Summary

Chemical kinetics is the study of chemical reactions with respect to reaction rates, effect of various variables, rearrangement of atoms and formation of intermediates. The rate of a reaction is concerned with decrease in concentration of reactants or increase in the concentration of products per unit time. It can be expressed as instantaneous rate at a particular instant of time and average rate over a large interval of time. A number of factors such as temperature, concentration of reactants, catalyst, affect the rate of a reaction. Mathematical representation of rate of a reaction is given by **rate law**. It has to be determined experimentally and cannot be predicted. **Order of a reaction** with respect to a

reactant is the power of its concentration which appears in the rate law equation. The order of a reaction is the sum of all such powers of concentration of terms for different reactants. **Rate constant** is the proportionality factor in the rate law. Rate constant and order of a reaction can be determined from rate law or its integrated rate equation. **Molecularity** is defined only for an elementary reaction. Its values are limited from 1 to 3 whereas order can be 0, 1, 2, 3 or even a fraction. Molecularity and order of an elementary reaction are same.

Temperature dependence of rate constants is described by Arrhenius equation ($k = Ae^{-E_a/RT}$). E_a corresponds to the **activation energy** and is given by the energy difference between activated complex and the reactant molecules, and A (Arrhenius factor or pre-exponential factor) corresponds to the collision frequency. The equation clearly shows that increase of temperature or lowering of E_a will lead to an increase in the rate of reaction and presence of a catalyst lowers the activation energy by providing an alternate path for the reaction. According to collision theory, another factor P called steric factor which refers to the orientation of molecules which collide, is important and contributes to effective collisions, thus, modifying the Arrhenius equation to $k = PZ_{AB}e^{-E_a/RT}$.

Exercises

- 4.1 From the rate expression for the following reactions, determine their order of reaction and the dimensions of the rate constants.

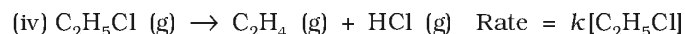
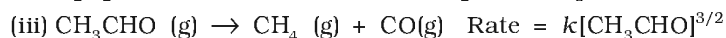
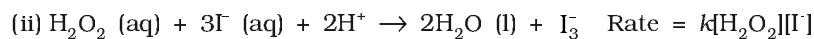
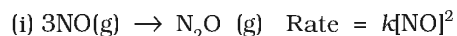

- 4.2 For the reaction:

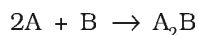

the rate = $k[\text{A}][\text{B}]^2$ with $k = 2.0 \times 10^{-6} \text{ mol}^{-2} \text{ L}^2 \text{ s}^{-1}$. Calculate the initial rate of the reaction when $[\text{A}] = 0.1 \text{ mol L}^{-1}$, $[\text{B}] = 0.2 \text{ mol L}^{-1}$. Calculate the rate of reaction after $[\text{A}]$ is reduced to 0.06 mol L^{-1} .

- 4.3 The decomposition of NH_3 on platinum surface is zero order reaction. What are the rates of production of N_2 and H_2 if $k = 2.5 \times 10^{-4} \text{ mol}^{-1} \text{ L s}^{-1}$?

- 4.4 The decomposition of dimethyl ether leads to the formation of CH_4 , H_2 and CO and the reaction rate is given by

$$\text{Rate} = k [\text{CH}_3\text{OCH}_3]^{3/2}$$

The rate of reaction is followed by increase in pressure in a closed vessel, so the rate can also be expressed in terms of the partial pressure of dimethyl ether, i.e.,

$$\text{Rate} = k(p_{\text{CH}_3\text{OCH}_3})^{3/2}$$

If the pressure is measured in bar and time in minutes, then what are the units of rate and rate constants?

- 4.5 Mention the factors that affect the rate of a chemical reaction.

4.6 A reaction is second order with respect to a reactant. How is the rate of reaction affected if the concentration of the reactant is
(i) doubled (ii) reduced to half ?

4.7 What is the effect of temperature on the rate constant of a reaction? How can this temperature effect on rate constant be represented quantitatively?

4.8 In a pseudo first order hydrolysis of ester in water, the following results were obtained:

t/s	0	30	60	90
[Ester]/mol L ⁻¹	0.55	0.31	0.17	0.085

(i) Calculate the average rate of reaction between the time interval 30 to 60 seconds.

(ii) Calculate the pseudo first order rate constant for the hydrolysis of ester.

4.9 A reaction is first order in A and second order in B.

(i) Write the differential rate equation.

(ii) How is the rate affected on increasing the concentration of B three times?

(iii) How is the rate affected when the concentrations of both A and B are doubled?

4.10 In a reaction between A and B, the initial rate of reaction (r_0) was measured for different initial concentrations of A and B as given below:

A/ mol L ⁻¹	0.20	0.20	0.40
B/ mol L ⁻¹	0.30	0.10	0.05
r_0 /mol L ⁻¹ s ⁻¹	5.07×10^{-5}	5.07×10^{-5}	1.43×10^{-4}

What is the order of the reaction with respect to A and B?

4.11 The following results have been obtained during the kinetic studies of the reaction:

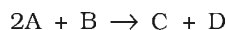

Experiment	[A]/mol L ⁻¹	[B]/mol L ⁻¹	Initial rate of formation of D/mol L ⁻¹ min ⁻¹
I	0.1	0.1	6.0×10^{-3}
II	0.3	0.2	7.2×10^{-2}
III	0.3	0.4	2.88×10^{-1}
IV	0.4	0.1	2.40×10^{-2}

Determine the rate law and the rate constant for the reaction.

4.12 The reaction between A and B is first order with respect to A and zero order with respect to B. Fill in the blanks in the following table:

Experiment	[A]/ mol L ⁻¹	[B]/ mol L ⁻¹	Initial rate/ mol L ⁻¹ min ⁻¹
I	0.1	0.1	2.0×10^{-2}
II	-	0.2	4.0×10^{-2}
III	0.4	0.4	-
IV	-	0.2	2.0×10^{-2}

4.13 Calculate the half-life of a first order reaction from their rate constants given below:

(i) 200 s^{-1} (ii) 2 min^{-1} (iii) 4 years^{-1}

4.14 The half-life for radioactive decay of ^{14}C is 5730 years. An archaeological artifact containing wood had only 80% of the ^{14}C found in a living tree. Estimate the age of the sample.

4.15 The experimental data for decomposition of N_2O_5

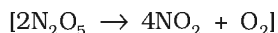

in gas phase at 318K are given below:

t/s	0	400	800	1200	1600	2000	2400	2800	3200
$10^2 \times [\text{N}_2\text{O}_5]/\text{mol L}^{-1}$	1.63	1.36	1.14	0.93	0.78	0.64	0.53	0.43	0.35

(i) Plot $[\text{N}_2\text{O}_5]$ against t .

(ii) Find the half-life period for the reaction.

(iii) Draw a graph between $\log[\text{N}_2\text{O}_5]$ and t .

(iv) What is the rate law ?

(v) Calculate the rate constant.

(vi) Calculate the half-life period from k and compare it with (ii).

4.16 The rate constant for a first order reaction is 60 s^{-1} . How much time will it take to reduce the initial concentration of the reactant to its $1/16^{\text{th}}$ value?

4.17 During nuclear explosion, one of the products is ^{90}Sr with half-life of 28.1 years. If $1\mu\text{g}$ of ^{90}Sr was absorbed in the bones of a newly born baby instead of calcium, how much of it will remain after 10 years and 60 years if it is not lost metabolically.

4.18 For a first order reaction, show that time required for 99% completion is twice the time required for the completion of 90% of reaction.

4.19 A first order reaction takes 40 min for 30% decomposition. Calculate $t_{1/2}$.

4.20 For the decomposition of azoisopropane to hexane and nitrogen at 543 K, the following data are obtained.

t (sec)	P(mm of Hg)
0	35.0
360	54.0
720	63.0

Calculate the rate constant.

4.21 The following data were obtained during the first order thermal decomposition of SO_2Cl_2 at a constant volume.

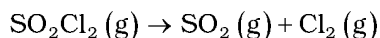

Experiment	Time/ s^{-1}	Total pressure/atm
1	0	0.5
2	100	0.6

Calculate the rate of the reaction when total pressure is 0.65 atm.

- 4.22** The rate constant for the decomposition of N_2O_5 at various temperatures is given below:

$T/^\circ\text{C}$	0	20	40	60	80
$10^5 \times k/\text{s}^{-1}$	0.0787	1.70	25.7	178	2140

Draw a graph between $\ln k$ and $1/T$ and calculate the values of A and E_a . Predict the rate constant at 30° and 50°C .

- 4.23** The rate constant for the decomposition of hydrocarbons is $2.418 \times 10^{-5}\text{s}^{-1}$ at 546K . If the energy of activation is 179.9kJ/mol , what will be the value of pre-exponential factor.
- 4.24** Consider a certain reaction $\text{A} \rightarrow \text{Products}$ with $k = 2.0 \times 10^{-2}\text{s}^{-1}$. Calculate the concentration of A remaining after 100s if the initial concentration of A is 1.0mol L^{-1} .
- 4.25** Sucrose decomposes in acid solution into glucose and fructose according to the first order rate law, with $t_{1/2} = 3.00\text{hours}$. What fraction of sample of sucrose remains after 8hours ?
- 4.26** The decomposition of hydrocarbon follows the equation
 $k = (4.5 \times 10^{11}\text{s}^{-1}) e^{-28000\text{K}/T}$
 Calculate E_a .
- 4.27** The rate constant for the first order decomposition of H_2O_2 is given by the following equation:
 $\log k = 14.34 - 1.25 \times 10^4\text{K}/T$
 Calculate E_a for this reaction and at what temperature will its half-period be 256minutes ?
- 4.28** The decomposition of A into product has value of k as $4.5 \times 10^3\text{s}^{-1}$ at 10°C and energy of activation 60kJ mol^{-1} . At what temperature would k be $1.5 \times 10^4\text{s}^{-1}$?
- 4.29** The time required for 10% completion of a first order reaction at 298K is equal to that required for its 25% completion at 308K . If the value of A is $4 \times 10^{10}\text{s}^{-1}$. Calculate k at 318K and E_a .
- 4.30** The rate of a reaction quadruples when the temperature changes from 293K to 313K . Calculate the energy of activation of the reaction assuming that it does not change with temperature.

Answers to Some Intext Questions

- 4.1** $r_{\text{av}} = 6.66 \times 10^{-6}\text{Ms}^{-1}$
- 4.2** Rate of reaction = rate of disappearance of A
 $= 0.005\text{mol litre}^{-1}\text{min}^{-1}$
- 4.3** Order of the reaction is 2.5
- 4.4** $\text{X} \rightarrow \text{Y}$
 Rate = $k[\text{X}]^2$
 The rate will increase 9 times
- 4.5** $t = 444\text{s}$
- 4.6** $1.925 \times 10^{-4}\text{s}^{-1}$
- 4.8** $E_a = 26.43\text{kJ mol}^{-1}$
- 4.9** 1.462×10^{-19}

Objectives

After studying this Unit, you will be able to

- describe interfacial phenomenon and its significance;
- define adsorption and classify it into physical and chemical adsorption;
- explain mechanism of adsorption;
- explain the factors controlling adsorption from gases and solutions on solids;
- explain adsorption results on the basis of Freundlich adsorption isotherms;
- appreciate the role of catalysts in industry;
- enumerate the nature of colloidal state;
- describe preparation, properties and purification of colloids;
- classify emulsions and describe their preparation and properties;
- describe the phenomenon of gel formation;
- list the uses of colloids.

Unit

5

Surface Chemistry

Some of the most important chemicals are produced industrially by means of reactions that occur on the surfaces of solid catalysts.

Surface chemistry deals with phenomena that occur at the surfaces or interfaces. The interface or surface is represented by separating the bulk phases by a hyphen or a slash. For example, the interface between a solid and a gas may be represented by solid-gas or solid/gas. Due to complete miscibility, there is no interface between the gases. The bulk phases that we come across in surface chemistry may be pure compounds or solutions. The interface is normally a few molecules thick but its area depends on the size of the particles of bulk phases. Many important phenomena, noticeable amongst these being corrosion, electrode processes, heterogeneous catalysis, dissolution and crystallisation occur at interfaces. The subject of surface chemistry finds many applications in industry, analytical work and daily life situations.

To accomplish surface studies meticulously, it becomes imperative to have a really clean surface. Under very high vacuum of the order of 10^{-8} to 10^{-9} pascal, it is now possible to obtain ultra clean surface of the metals. Solid materials with such clean surfaces need to be stored in vacuum otherwise these will be covered by molecules of the major components of air namely dioxygen and dinitrogen.

In this Unit, you will be studying some important features of surface chemistry such as adsorption, catalysis and colloids including emulsions and gels.

5.1 Adsorption

There are several examples, which reveal that the surface of a solid has the tendency to attract and retain the molecules of the phase with which it comes into contact. These molecules remain only at the surface and do not go deeper into the bulk. **The accumulation of molecular species at the surface rather than in the bulk of a solid or liquid is termed adsorption.** The molecular species or substance, which concentrates or accumulates at the surface is termed **adsorbate** and the material on the surface of which the adsorption takes place is called **adsorbent**.

Adsorption is essentially a surface phenomenon. Solids, particularly in finely divided state, have large surface area and therefore, charcoal, silica gel, alumina gel, clay, colloids, metals in finely divided state, etc. act as good adsorbents.

Adsorption in action

- (i) If a gas like O_2 , H_2 , CO , Cl_2 , NH_3 or SO_2 is taken in a closed vessel containing powdered charcoal, it is observed that the pressure of the gas in the enclosed vessel decreases. The gas molecules concentrate at the surface of the charcoal, i.e., gases are adsorbed at the surface.
- (ii) In a solution of an organic dye, say methylene blue, when animal charcoal is added and the solution is well shaken, it is observed that the filtrate turns colourless. The molecules of the dye, thus, accumulate on the surface of charcoal, i.e., are adsorbed.
- (iii) Aqueous solution of raw sugar, when passed over beds of animal charcoal, becomes colourless as the colouring substances are adsorbed by the charcoal.
- (iv) The air becomes dry in the presence of silica gel because the water molecules get adsorbed on the surface of the gel.

It is clear from the above examples that solid surfaces can hold the gas or liquid molecules by virtue of adsorption. The process of removing an adsorbed substance from a surface on which it is adsorbed is called **desorption**.

5.1.1 Distinction between Adsorption and Absorption

In adsorption, the substance is concentrated only at the surface and does not penetrate through the surface to the bulk of the adsorbent, while in absorption, the substance is uniformly distributed throughout the bulk of the solid. For example, when a chalk stick is dipped in ink, the surface retains the colour of the ink due to adsorption of coloured molecules while the solvent of the ink goes deeper into the stick due to absorption. On breaking the chalk stick, it is found to be white from inside. A distinction can be made between absorption and adsorption by taking an example of water vapour. Water vapours are absorbed by anhydrous calcium chloride but adsorbed by silica gel. In other words, in adsorption the concentration of the adsorbate increases only at the surface of the adsorbent, while in absorption the concentration is uniform throughout the bulk of the solid.

Both adsorption and absorption can take place simultaneously also. The term sorption is used to describe both the processes.

5.1.2 Mechanism of Adsorption

Adsorption arises due to the fact that the surface particles of the adsorbent are not in the same environment as the particles inside the bulk. Inside the adsorbent all the forces acting between the particles are mutually

balanced but on the surface the particles are not surrounded by atoms or molecules of their kind on all sides, and hence they possess unbalanced or residual attractive forces. These forces of the adsorbent are responsible for attracting the adsorbate particles on its surface. The extent of adsorption increases with the increase of surface area per unit mass of the adsorbent at a given temperature and pressure.

Another important factor featuring adsorption is the heat of adsorption. During adsorption, there is always a decrease in residual forces of the surface, i.e., there is decrease in surface energy which appears as heat. Adsorption, therefore, is invariably an exothermic process. In other words, ΔH of adsorption is always negative. When a gas is adsorbed, the freedom of movement of its molecules become restricted. This amounts to decrease in the entropy of the gas after adsorption, i.e., ΔS is negative. Adsorption is thus accompanied by decrease in enthalpy as well as decrease in entropy of the system. For a process to be spontaneous, the thermodynamic requirement is that, at constant temperature and pressure, ΔG must be negative, i.e., there is a decrease in Gibbs energy. On the basis of equation, $\Delta G = \Delta H - T\Delta S$, ΔG can be negative if ΔH has sufficiently high negative value as $-T\Delta S$ is positive. Thus, in an adsorption process, which is spontaneous, a combination of these two factors makes ΔG negative. As the adsorption proceeds, ΔH becomes less and less negative ultimately ΔH becomes equal to $T\Delta S$ and ΔG becomes zero. At this state equilibrium is attained.

5.1.3 Types of Adsorption

There are mainly two types of adsorption of gases on solids. If accumulation of gas on the surface of a solid occurs on account of weak van der Waals' forces, the adsorption is termed as **physical adsorption or physisorption**. When the gas molecules or atoms are held to the solid surface by chemical bonds, the adsorption is termed **chemical adsorption or chemisorption**. The chemical bonds may be covalent or ionic in nature. Chemisorption involves a high energy of activation and is, therefore, often referred to as activated adsorption. Sometimes these two processes occur simultaneously and it is not easy to ascertain the type of adsorption. A physical adsorption at low temperature may pass into chemisorption as the temperature is increased. For example, dihydrogen is first adsorbed on nickel by van der Waals' forces. Molecules of hydrogen then dissociate to form hydrogen atoms which are held on the surface by chemisorption.

Some of the important characteristics of both types of adsorption are described below:

Characteristics of physisorption

- (i) *Lack of specificity*: A given surface of an adsorbent does not show any preference for a particular gas as the van der Waals' forces are universal.
- (ii) *Nature of adsorbate*: The amount of gas adsorbed by a solid depends on the nature of gas. In general, easily liquefiable gases (i.e., with higher critical temperatures) are readily adsorbed as van der Waals' forces are stronger near the critical temperatures. Thus, 1g of activated charcoal adsorbs more sulphur dioxide (critical temperature 630K), than methane (critical temperature 190K) which is still more than 4.5 mL of dihydrogen (critical temperature 33K).

- (iii) *Reversible nature:* Physical adsorption of a gas by a solid is generally reversible. Thus,



More of gas is adsorbed when pressure is increased as the volume of the gas decreases (Le-Chatelier's principle) and the gas can be removed by decreasing pressure. Since the adsorption process is exothermic, the physical adsorption occurs readily at low temperature and decreases with increasing temperature (Le-Chatelier's principle).

- (iv) *Surface area of adsorbent:* The extent of adsorption increases with the increase of surface area of the adsorbent. Thus, finely divided metals and porous substances having large surface areas are good adsorbents.
- (v) *Enthalpy of adsorption:* No doubt, physical adsorption is an exothermic process but its enthalpy of adsorption is quite low (20–40 kJ mol⁻¹). This is because the attraction between gas molecules and solid surface is only due to weak van der Waals' forces.

Characteristics of chemisorption

- (i) *High specificity:* Chemisorption is highly specific and it will only occur if there is some possibility of chemical bonding between adsorbent and adsorbate. For example, oxygen is adsorbed on metals by virtue of oxide formation and hydrogen is adsorbed by transition metals due to hydride formation.
- (ii) *Irreversibility:* As chemisorption involves compound formation, it is usually irreversible in nature. Chemisorption is also an exothermic process but the process is very slow at low temperatures on account of high energy of activation. Like most chemical changes, adsorption often increases with rise of temperature. Physisorption of a gas adsorbed at low temperature may change into chemisorption at a high temperature. Usually high pressure is also favourable for chemisorption.
- (iii) *Surface area:* Like physical adsorption, chemisorption also increases with increase of surface area of the adsorbent.
- (iv) *Enthalpy of adsorption:* Enthalpy of chemisorption is high (80–240 kJ mol⁻¹) as it involves chemical bond formation.

Table 5.1: Comparison of Physisorption and Chemisorption

Physisorption	Chemisorption
1. It arises because of van der Waals' forces.	1. It is caused by chemical bond formation.
2. It is not specific in nature.	2. It is highly specific in nature.
3. It is reversible in nature.	3. It is irreversible.
4. It depends on the nature of gas. More easily liquefiable gases are adsorbed readily.	4. It also depends on the nature of gas. Gases which can react with the adsorbent show chemisorption.
5. Enthalpy of adsorption is low (20–40 kJ mol ⁻¹) in this case.	5. Enthalpy of adsorption is high (80–240 kJ mol ⁻¹) in this case.

- | | |
|---|--|
| 6. Low temperature is favourable for adsorption. It decreases with increase of temperature. | 6. High temperature is favourable for adsorption. It increases with the increase of temperature. |
| 7. No appreciable activation energy is needed. | 7. High activation energy is sometimes needed. |
| 8. It depends on the surface area. It increases with an increase of surface area. | 8. It also depends on the surface area. It too increases with an increase of surface area. |
| 9. It results into multimolecular layers on adsorbent surface under high pressure. | 9. It results into unimolecular layer. |

5.1.4 Adsorption Isotherms

The variation in the amount of gas adsorbed by the adsorbent with pressure at constant temperature can be expressed by means of a curve termed as **adsorption isotherm**.

Freundlich adsorption isotherm: Freundlich, in 1909, gave an empirical relationship between the quantity of gas adsorbed by unit mass of solid adsorbent and pressure at a particular temperature. The relationship can be expressed by the following equation:

$$\frac{x}{m} = k.P^{1/n} \quad (n > 1) \quad \dots (5.1)$$

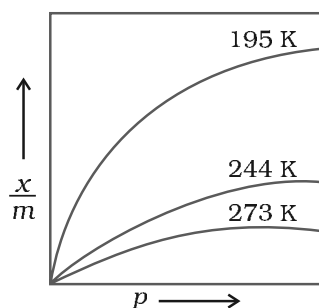

Fig. 5.1: Adsorption isotherm

where x is the mass of the gas adsorbed on mass m of the adsorbent at pressure P , k and n are constants which depend on the nature of the adsorbent and the gas at a particular temperature. The relationship is generally represented in the form of a curve where mass of the gas adsorbed per gram of the adsorbent is plotted against pressure (Fig. 5.1). These curves indicate that at a fixed pressure, there is a decrease in physical adsorption with increase in temperature. These curves always seem to approach saturation at high pressure.

Taking logarithm of eq. (5.1)

$$\log \frac{x}{m} = \log k + \frac{1}{n} \log P \quad \dots (5.2)$$

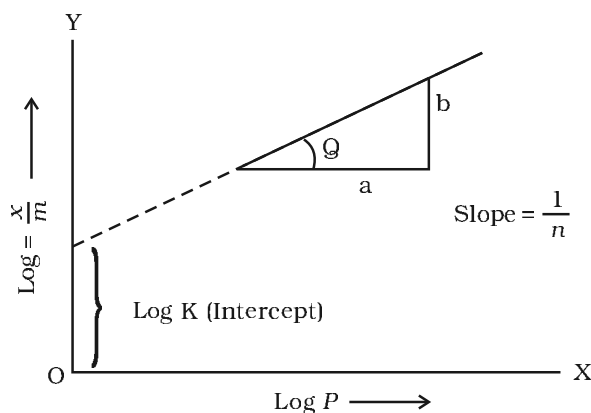

Fig. 5.2: Freundlich isotherm

The validity of Freundlich isotherm can be verified by plotting $\log \frac{x}{m}$ on y -axis (ordinate) and $\log P$ on x -axis (abscissa). If it comes to be a straight line, the Freundlich isotherm is valid, otherwise not (Fig. 5.2). The slope of the straight line gives the value of $\frac{1}{n}$. The intercept on the y -axis gives the value of $\log k$.

Freundlich isotherm explains the behaviour of adsorption in an approximate manner. The factor $\frac{1}{n}$ can have values between 0 and 1 (probable range 0.1 to 0.5). Thus, equation (5.2) holds good over a limited range of pressure.

When $\frac{1}{n} = 0$, $\frac{x}{m} = \text{constant}$, the adsorption is independent of pressure.

When $\frac{1}{n} = 1$, $\frac{x}{m} = kP$, i.e. $\frac{x}{m} \propto P$, the adsorption varies directly with pressure.

Both the conditions are supported by experimental results. The experimental isotherms always seem to approach saturation at high pressure. This cannot be explained by Freundlich isotherm. Thus, it fails at high pressure.

5.1.5 Adsorption from Solution Phase

Solids can adsorb solutes from solutions also. When a solution of acetic acid in water is shaken with charcoal, a part of the acid is adsorbed by the charcoal and the concentration of the acid decreases in the solution. Similarly, the litmus solution when shaken with charcoal becomes colourless. The precipitate of $\text{Mg}(\text{OH})_2$ attains blue colour when precipitated in presence of magnesium reagent. The colour is due to adsorption of magnesium. The following observations have been made in the case of adsorption from solution phase:

- (i) The extent of adsorption decreases with an increase in temperature.
- (ii) The extent of adsorption increases with an increase of surface area of the adsorbent.
- (iii) The extent of adsorption depends on the concentration of the solute in solution.
- (iv) The extent of adsorption depends on the nature of the adsorbent and the adsorbate.

The precise mechanism of adsorption from solution is not known. Freundlich's equation approximately describes the behaviour of adsorption from solution with a difference that instead of pressure, concentration of the solution is taken into account, i.e.,

$$\frac{x}{m} = kC^{1/n} \quad \dots(5.3)$$

(C is the equilibrium concentration, i.e., when adsorption is complete). On taking logarithm of the above equation, we have

$$\log \frac{x}{m} = \log k + \frac{1}{n} \log C \quad \dots(5.4)$$

Plotting $\log \frac{x}{m}$ against $\log C$ a straight line is obtained which shows the validity of Freundlich isotherm. This can be tested experimentally by taking solutions of different concentrations of acetic acid. Equal volumes of solutions are added to equal amounts of charcoal in different flasks. The final concentration is determined in each flask after adsorption. The difference in the initial and final concentrations give the value of x. Using the above equation, validity of Freundlich isotherm can be established.

5.1.6 Applications of Adsorption

The phenomenon of adsorption finds a number of applications. Important ones are listed here:

- (i) *Production of high vacuum*: The remaining traces of air can be adsorbed by charcoal from a vessel evacuated by a vacuum pump to give a very high vacuum.

- (ii) *Gas masks*: Gas mask (a device which consists of activated charcoal or mixture of adsorbents) is usually used for breathing in coal mines to adsorb poisonous gases.
- (iii) *Control of humidity*: Silica and aluminium gels are used as adsorbents for removing moisture and controlling humidity.
- (iv) *Removal of colouring matter from solutions*: Animal charcoal removes colours of solutions by adsorbing coloured impurities.
- (v) *Heterogeneous catalysis*: Adsorption of reactants on the solid surface of the catalysts increases the rate of reaction. There are many gaseous reactions of industrial importance involving solid catalysts. Manufacture of ammonia using iron as a catalyst, manufacture of H_2SO_4 by contact process and use of finely divided nickel in the hydrogenation of oils are excellent examples of heterogeneous catalysis.
- (vi) *Separation of inert gases*: Due to the difference in degree of adsorption of gases by charcoal, a mixture of noble gases can be separated by adsorption on coconut charcoal at different temperatures.
- (vii) *In curing diseases*: A number of drugs are used to kill germs by getting adsorbed on them.
- (viii) *Froth floatation process*: A low grade sulphide ore is concentrated by separating it from silica and other earthy matter by this method using pine oil and frothing agent (see Unit 6).
- (ix) *Adsorption indicators*: Surfaces of certain precipitates such as silver halides have the property of adsorbing some dyes like eosin, fluorescein, etc. and thereby producing a characteristic colour at the end point.
- (x) *Chromatographic analysis*: Chromatographic analysis based on the phenomenon of adsorption finds a number of applications in analytical and industrial fields.

Intext Questions

- 5.1** Why are substances like platinum and palladium often used for carrying out electrolysis of aqueous solutions?
- 5.2** Why does physisorption decrease with the increase of temperature?
- 5.3** Why are powdered substances more effective adsorbents than their crystalline forms?

5.2 Catalysis

Potassium chlorate, when heated strongly decomposes slowly giving dioxygen. The decomposition occurs in the temperature range of 653-873K.

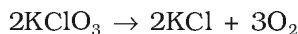

However, when a little of manganese dioxide is added, the decomposition takes place at a considerably lower temperature range, i.e., 473-633K and also at a much accelerated rate. The added manganese dioxide remains unchanged with respect to its mass and composition. In a similar manner, the rates of a number of chemical reactions can be altered by the mere presence of a foreign substance.

The systematic study of the effect of various foreign substances on the rates of chemical reactions was first made by Berzelius, in 1835. He suggested the term **catalyst** for such substances.

Substances, which alter the rate of a chemical reaction and themselves remain chemically and quantitatively unchanged after the reaction, are known as catalysts, and the phenomenon is known as catalysis. You have already studied about catalysts and its functioning in Section 4.5.

Promoters and poisons

Promoters are substances that enhance the activity of a catalyst while poisons decrease the activity of a catalyst. For example, in Haber's process for manufacture of ammonia, molybdenum acts as a promoter for iron which is used as a catalyst.

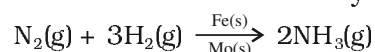

5.2.1 Homogeneous and Heterogeneous Catalysis

Catalysis can be broadly divided into two groups:

(a) Homogeneous catalysis

When the reactants and the catalyst are in the same phase (i.e., liquid or gas), the process is said to be homogeneous catalysis. The following are some of the examples of homogeneous catalysis:

- (i) Oxidation of sulphur dioxide into sulphur trioxide with dioxygen in the presence of oxides of nitrogen as the catalyst in the lead chamber process.

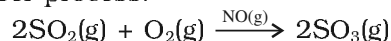

The reactants, sulphur dioxide and oxygen, and the catalyst, nitric oxide, are all in the same phase.

- (ii) Hydrolysis of methyl acetate is catalysed by H^+ ions furnished by hydrochloric acid.

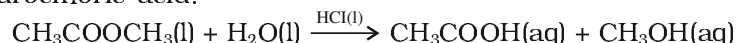

Both the reactants and the catalyst are in the same phase.

- (iii) Hydrolysis of sugar is catalysed by H^+ ions furnished by sulphuric acid.

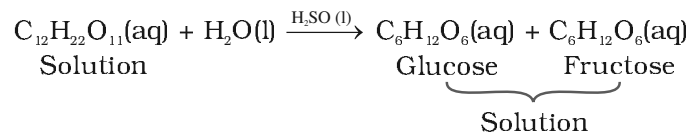

Both the reactants and the catalyst are in the same phase.

(b) Heterogeneous catalysis

The catalytic process in which the reactants and the catalyst are in different phases is known as heterogeneous catalysis. Some of the examples of heterogeneous catalysis are given below:

- (i) Oxidation of sulphur dioxide into sulphur trioxide in the presence of Pt.

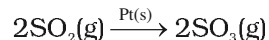

The reactant is in gaseous state while the catalyst is in the solid state.

- (ii) Combination between dinitrogen and dihydrogen to form ammonia in the presence of finely divided iron in Haber's process.

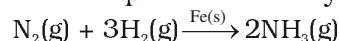

The reactants are in gaseous state while the catalyst is in the solid state.

- (iii) Oxidation of ammonia into nitric oxide in the presence of platinum gauze in Ostwald's process.

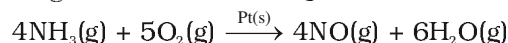

The reactants are in gaseous state while the catalyst is in the solid state.

- (iv) Hydrogenation of vegetable oils in the presence of finely divided nickel as catalyst.

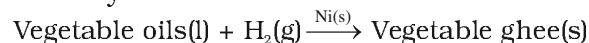

One of the reactants is in liquid state and the other in gaseous state while the catalyst is in the solid state.

5.2.2 Adsorption Theory of Heterogeneous Catalysis

This theory explains the mechanism of heterogeneous catalysis. The old theory, known as adsorption theory of catalysis, was that the reactants in gaseous state or in solutions, are adsorbed on the surface of the solid catalyst. The increase in concentration of the reactants on the surface increases the rate of reaction. Adsorption being an exothermic process, the heat of adsorption is utilised in enhancing the rate of the reaction.

The catalytic action can be explained in terms of the intermediate compound formation, the theory of which you have already studied in Section 4.5.1

The modern adsorption theory is the combination of intermediate compound formation theory and the old adsorption theory. The catalytic activity is localised on the surface of the catalyst. The mechanism involves five steps:

- (i) Diffusion of reactants to the surface of the catalyst.
 - (ii) Adsorption of reactant molecules on the surface of the catalyst.
 - (iii) Occurrence of chemical reaction on the catalyst's surface through formation of an intermediate (Fig. 5.3).
 - (iv) Desorption of reaction products from the catalyst surface, and thereby, making the surface available again for more reaction to occur.
 - (v) Diffusion of reaction products away from the catalyst's surface.
- The surface of the catalyst unlike the inner part of the bulk, has free valencies which provide the seat for chemical forces of attraction. When a gas comes in contact with such a surface, its molecules are held up there due to loose chemical combination. If different molecules are adsorbed side by side, they may react with each other resulting in the formation of new molecules. Thus, formed molecules may evaporate leaving the surface for the fresh reactant molecules.

This theory explains why the catalyst remains unchanged in mass and chemical composition at the end of the reaction and is effective

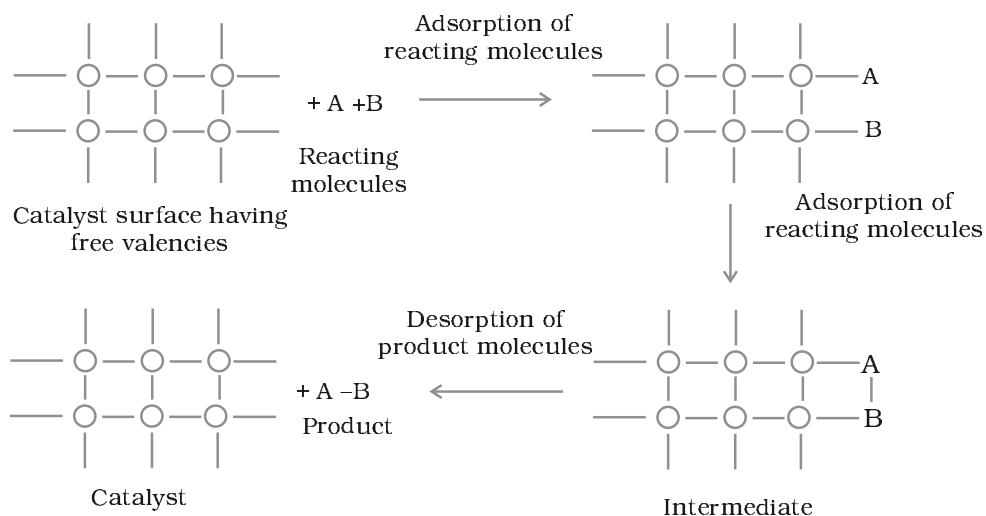

Fig. 5.3
Adsorption of reacting molecules, formation of intermediate and desorption of products

even in small quantities. It however, does not explain the action of catalytic promoters and catalytic poisons.

Important features of solid catalysts

(a) Activity

The activity of a catalyst depends upon the strength of chemisorption to a large extent. The reactants must get adsorbed reasonably strongly on to the catalyst to become active. However, they must not get adsorbed so strongly that they are immobilised and other reactants are left with no space on the catalyst's surface for adsorption. It has been found that for hydrogenation reaction, the catalytic activity increases from Group 5 to Group 11 metals with maximum activity being shown by groups 7-9 elements of the periodic table (Class XI, Unit 3).

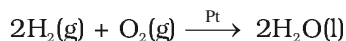

(b) Selectivity

The selectivity of a catalyst is its ability to direct a reaction to yield a particular product. For example, starting with H_2 and CO , and using different catalysts, we get different products.

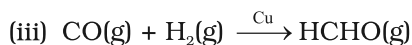
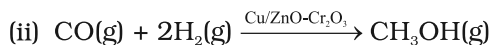
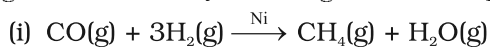

Thus, it can be inferred that the action of a catalyst is highly selective in nature, i.e., a given substance can act as a catalyst only in a particular reaction and not for all the reactions. It means that a substance which acts as a catalyst in one reaction may fail to catalyse another reaction.

5.2.3 Shape-Selective Catalysis by Zeolites

The catalytic reaction that depends upon the pore structure of the catalyst and the size of the reactant and product molecules is called **shape-selective catalysis**. Zeolites are good shape-selective catalysts because of their honeycomb-like structures. They are microporous

aluminosilicates with three dimensional network of silicates in which some silicon atoms are replaced by aluminium atoms giving Al–O–Si framework. The reactions taking place in zeolites depend upon the size and shape of reactant and product molecules as well as upon the pores and cavities of the zeolites. They are found in nature as well as synthesised for catalytic selectivity.

Zeolites are being very widely used as catalysts in petrochemical industries for cracking of hydrocarbons and isomerisation. An important zeolite catalyst used in the petroleum industry is ZSM-5. It converts alcohols directly into gasoline (petrol) by dehydrating them to give a mixture of hydrocarbons.

5.2.4 Enzyme Catalysis

Enzymes are complex nitrogenous organic compounds which are produced by living plants and animals. They are actually protein molecules of high molecular mass and form colloidal solutions in water. They are very effective catalysts; catalyse numerous reactions, especially those connected with natural processes. Numerous reactions that occur in the bodies of animals and plants to maintain the life process are catalysed by enzymes. The enzymes are, thus, termed as **biochemical catalysts** and the phenomenon is known as **biochemical catalysis**.

Many enzymes have been obtained in pure crystalline state from living cells. However, the first enzyme was synthesised in the laboratory in 1969. The following are some of the examples of enzyme-catalysed reactions:

- (i) *Inversion of cane sugar*: The invertase enzyme converts cane sugar into glucose and fructose.

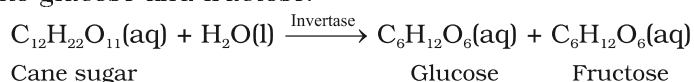

- (ii) *Conversion of glucose into ethyl alcohol*: The zymase enzyme converts glucose into ethyl alcohol and carbon dioxide.

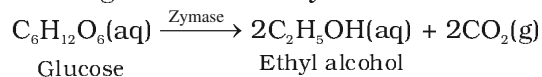

- (iii) *Conversion of starch into maltose*: The diastase enzyme converts starch into maltose.

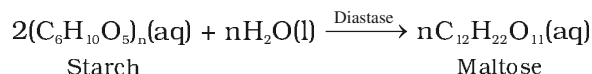

- (iv) *Conversion of maltose into glucose*: The maltase enzyme converts maltose into glucose.

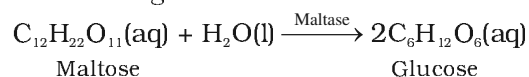

- (v) *Decomposition of urea into ammonia and carbon dioxide*: The enzyme urease catalyses this decomposition.

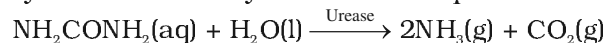

- (vi) In stomach, the pepsin enzyme converts proteins into peptides while in intestine, the pancreatic trypsin converts proteins into amino acids by hydrolysis.

- (vii) *Conversion of milk into curd*: It is an enzymatic reaction brought about by lacto bacilli enzyme present in curd.

Table 5.2 gives the summary of some important enzymatic reactions.

Table 5.2: Some Enzymatic Reactions

Enzyme	Source	Enzymatic reaction
Invertase	Yeast	Sucrose → Glucose and fructose
Zymase	Yeast	Glucose → Ethyl alcohol and carbon dioxide
Diastase	Malt	Starch → Maltose
Maltase	Yeast	Maltose → Glucose
Urease	Soyabean	Urea → Ammonia and carbon dioxide
Pepsin	Stomach	Proteins → Amino acids

Characteristics of enzyme catalysis

Enzyme catalysis is unique in its efficiency and high degree of specificity. The following characteristics are exhibited by enzyme catalysts:

- (i) *Most highly efficient:* One molecule of an enzyme may transform one million molecules of the reactant per minute.
- (ii) *Highly specific nature:* Each enzyme is specific for a given reaction, i.e., one catalyst cannot catalyse more than one reaction. For example, the enzyme urease catalyses the hydrolysis of urea only. It does not catalyse hydrolysis of any other amide.
- (iii) *Highly active under optimum temperature:* The rate of an enzyme reaction becomes maximum at a definite temperature, called the optimum temperature. On either side of the optimum temperature, the enzyme activity decreases. The optimum temperature range for enzymatic activity is 298-310K. Human body temperature being 310 K is suited for enzyme-catalysed reactions.
- (iv) *Highly active under optimum pH:* The rate of an enzyme-catalysed reaction is maximum at a particular pH called optimum pH, which is between pH values 5-7.
- (v) *Increasing activity in presence of activators and co-enzymes:* The enzymatic activity is increased in the presence of certain substances, known as co-enzymes. It has been observed that when a small non-protein (vitamin) is present along with an enzyme, the catalytic activity is enhanced considerably.
Activators are generally metal ions such as Na^+ , Mn^{2+} , Co^{2+} , Cu^{2+} , etc. These metal ions, when weakly bonded to enzyme molecules, increase their catalytic activity. Amylase in presence of sodium chloride i.e., Na^+ ions are catalytically very active.
- (vi) *Influence of inhibitors and poisons:* Like ordinary catalysts, enzymes are also inhibited or poisoned by the presence of certain substances. The inhibitors or poisons interact with the active functional groups on the enzyme surface and often reduce or completely destroy the catalytic activity of the enzymes. The use of many drugs is related to their action as enzyme inhibitors in the body.

Mechanism of enzyme catalysis

There are a number of cavities present on the surface of colloidal particles of enzymes. These cavities are of characteristic shape and possess active groups such as $-\text{NH}_2$, $-\text{COOH}$, $-\text{SH}$, $-\text{OH}$, etc. These are actually the active

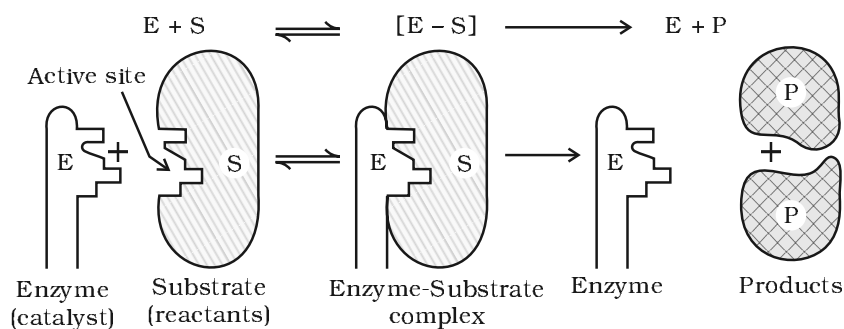

Fig. 5.4: Mechanism of enzyme catalysed reaction

centres on the surface of enzyme particles. The molecules of the reactant (substrate), which have complementary shape, fit into these cavities just like a key fits into a lock. On account of the presence of active groups, an activated complex is formed which then decomposes to yield the products.

Thus, the enzyme-catalysed reactions may be considered to proceed in two steps.

Step 1: Binding of enzyme to substrate to form an activated complex.
 $E + S \rightarrow ES^{\ddagger}$

Step 2: Decomposition of the activated complex to form product.
 $ES^{\ddagger} \rightarrow E + P$

5.2.5 Catalysts in Industry

Some of the important technical catalytic processes are listed in Table 5.3 to give an idea about the utility of catalysts in industries.

Table 5.3: Some Industrial Catalytic Processes

Process	Catalyst
1. Haber's process for the manufacture of ammonia $N_2(g) + 3H_2(g) \rightarrow 2NH_3(g)$	Finely divided iron, molybdenum as promoter; conditions: 200 bar pressure and 723-773K temperature.
2. Ostwald's process for the manufacture of nitric acid. $4NH_3(g) + 5O_2(g) \rightarrow 4NO(g) + 6H_2O(g)$ $2NO(g) + O_2(g) \rightarrow 2NO_2(g)$ $4NO_2(g) + 2H_2O(l) + O_2(g) \rightarrow 4HNO_3(aq)$	Platinised asbestos; temperature 573K.
3. Contact process for the manufacture of sulphuric acid. $2SO_2(g) + O_2(g) \rightarrow 2SO_3(g)$ $SO_3(g) + H_2SO_4(aq) \rightarrow H_2S_2O_7(l)$ oleum $H_2S_2O_7(l) + H_2O(l) \rightarrow 2H_2SO_4(aq)$	Platinised asbestos or vanadium pentoxide (V_2O_5); temperature 673-723K.

Intext Questions

- 5.4** Why is it necessary to remove CO when ammonia is obtained by Haber's process?
- 5.5** Why is the ester hydrolysis slow in the beginning and becomes faster after sometime?
- 5.6** What is the role of desorption in the process of catalysis.

5.3 Colloids

We have learnt in Unit 2 that solutions are homogeneous systems. We also know that sand in water when stirred gives a suspension, which slowly settles down with time. Between the two extremes of suspensions and solutions we come across a large group of systems called colloidal dispersions or simply colloids.

A colloid is a heterogeneous system in which one substance is dispersed (dispersed phase) as very fine particles in another substance called dispersion medium.

The essential difference between a solution and a colloid is that of particle size. While in a solution, the constituent particles are ions or small molecules, in a colloid, the dispersed phase may consist of particles of a single macromolecule (such as protein or synthetic polymer) or an aggregate of many atoms, ions or molecules. Colloidal particles are larger than simple molecules but small enough to remain suspended. Their range of diameters is between 1 and 1000 nm (10^{-9} to 10^{-6} m).

Colloidal particles have an enormous surface area per unit mass as a result of their small size. Consider a cube with 1 cm side. It has a total surface area of 6 cm². If it were divided equally into 10^{12} cubes, the cubes would be the size of large colloidal particles and have a total surface area of 60,000 cm² or 6 m². This enormous surface area leads to some special properties of colloids to be discussed later in this Unit.

5.4 Classification of Colloids

Colloids are classified on the basis of the following criteria:

- (i) Physical state of dispersed phase and dispersion medium
- (ii) Nature of interaction between dispersed phase and dispersion medium
- (iii) Type of particles of the dispersed phase.

5.4.1 Classification Based on Physical State of Dispersed Phase and Dispersion Medium

Depending upon whether the dispersed phase and the dispersion medium are solids, liquids or gases, eight types of colloidal systems are possible. A gas mixed with another gas forms a homogeneous mixture and hence is not a colloidal system. The examples of the various types of colloids along with their typical names are listed in Table 5.4.

Table 5.4: Types of Colloidal Systems

Dispersed phase	Dispersion medium	Type of colloid	Examples
Solid	Solid	Solid sol	Some coloured glasses and gem stones
Solid	Liquid	Sol	Paints, cell fluids
Solid	Gas	Aerosol	Smoke, dust
Liquid	Solid	Gel	Cheese, butter, jellies
Liquid	Liquid	Emulsion	Milk, hair cream
Liquid	Gas	Aerosol	Fog, mist, cloud, insecticide sprays
Gas	Solid	Solid sol	Pumice stone, foam rubber
Gas	Liquid	Foam	Froth, whipped cream, soap lather

Many familiar commercial products and natural objects are colloids. For example, whipped cream is a foam, which is a gas dispersed in a liquid. Firefighting foams, used at emergency airplane landings are also colloidal systems. Most biological fluids are aqueous sols (solids dispersed in water). Within a typical cell, proteins and nucleic acids are colloidal-sized particles dispersed in an aqueous solution of ions and small molecules.

Out of the various types of colloids given in Table 5.4, the most common are **sols** (solids in liquids), **gels** (liquids in solids) and **emulsions** (liquids in liquids). However, in the present Unit, we shall take up discussion of the 'sols' and 'emulsions' only. Further, it may be mentioned that if the dispersion medium is water, the sol is called aquasol or hydrosol and if the dispersion medium is alcohol, it is called alcosol and so on.

5.4.2 Classification Based on Nature of Interaction between Dispersed Phase and Dispersion Medium

Depending upon the nature of interaction between the dispersed phase and the dispersion medium, colloidal sols are divided into two categories, namely, **lyophilic** (solvent attracting) and **lyophobic** (solvent repelling). If water is the dispersion medium, the terms used are hydrophilic and hydrophobic.

- (i) *Lyophilic colloids*: The word 'lyophilic' means liquid-loving. Colloidal sols directly formed by mixing substances like gum, gelatine, starch, rubber, etc., with a suitable liquid (the dispersion medium) are called lyophilic sols. An important characteristic of these sols is that if the dispersion medium is separated from the dispersed phase (say by evaporation), the sol can be reconstituted by simply remixing with the dispersion medium. That is why these sols are also called **reversible sols**. Furthermore, these sols are quite stable and cannot be easily coagulated as discussed later.
- (ii) *Lyophobic colloids*: The word 'lyophobic' means liquid-hating. Substances like metals, their sulphides, etc., when simply mixed with the dispersion medium do not form the colloidal sol. Their colloidal sols can be prepared only by special methods (as discussed later). Such sols are called lyophobic sols. These sols are readily precipitated (or coagulated) on the addition of small amounts of electrolytes, by heating or by shaking and hence, are not stable. Further, once precipitated, they do not give back the colloidal sol by simple addition of the dispersion medium. Hence, these sols are also called **irreversible sols**. Lyophobic sols need stabilising agents for their preservation.

5.4.3 Classification Based on Type of Particles of the Dispersed Phase, Multimolecular, Macromolecular and Associated Colloids

Depending upon the type of the particles of the dispersed phase, colloids are classified as: multimolecular, macromolecular and associated colloids.

- (i) *Multimolecular colloids*: On dissolution, a large number of atoms or smaller molecules of a substance aggregate together to form species having size in the colloidal range (diameter < 1 nm). The species thus formed are called multimolecular colloids. For example, a gold sol may contain particles of various sizes having many atoms. Sulphur sol consists of particles containing a thousand or more of S₈ sulphur molecules.

- (ii) *Macromolecular colloids*: Macromolecules (Unit 15) in suitable solvents form solutions in which the size of the macromolecules may be in the colloidal range. Such systems are called macromolecular colloids. These colloids are quite stable and resemble true solutions in many respects. Examples of naturally occurring macromolecules are starch, cellulose, proteins and enzymes; and those of man-made macromolecules are polythene, nylon, polystyrene, synthetic rubber, etc.
- (iii) *Associated colloids (Micelles)*: There are some substances which at low concentrations behave as normal strong electrolytes, but at higher concentrations exhibit colloidal behaviour due to the formation of aggregates. The aggregated particles thus formed are called **micelles**. These are also known as **associated colloids**. The formation of micelles takes place only above a particular temperature called **Kraft temperature (T_k)** and above a particular concentration called **critical micelle concentration (CMC)**. On dilution, these colloids revert back to individual ions. Surface active agents such as soaps and synthetic detergents belong to this class. For soaps, the CMC is 10^{-4} to 10^{-3} mol L⁻¹. These colloids have both lyophobic and lyophilic parts. Micelles may contain as many as 100 molecules or more.

Mechanism of micelle formation

Let us take the example of soap solutions. Soap is sodium or potassium salt of a higher fatty acid and may be represented as RCOO⁻Na⁺ (e.g., sodium stearate CH₃(CH₂)₁₆COO⁻Na⁺, which is a major component of many bar soaps). When dissolved in water, it dissociates into RCOO⁻ and Na⁺ ions. The RCOO⁻ ions, however, consist of two parts — a long hydrocarbon chain R (also called non-polar 'tail') which is hydrophobic (water repelling), and a polar group COO⁻ (also called polar-ionic 'head'), which is hydrophilic (water loving).

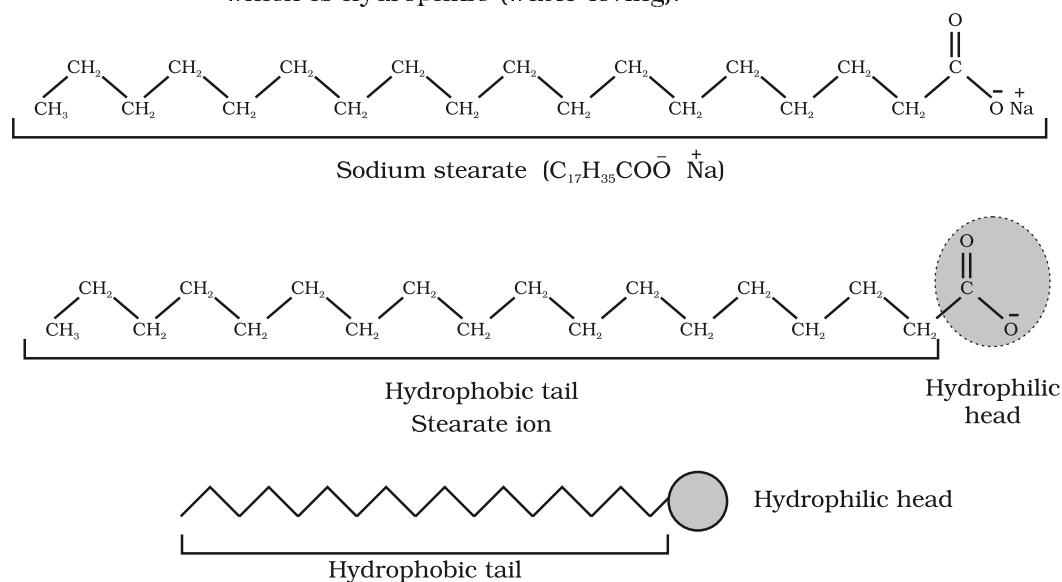

Fig. 5.5: Hydrophobic and hydrophilic parts of stearate ion

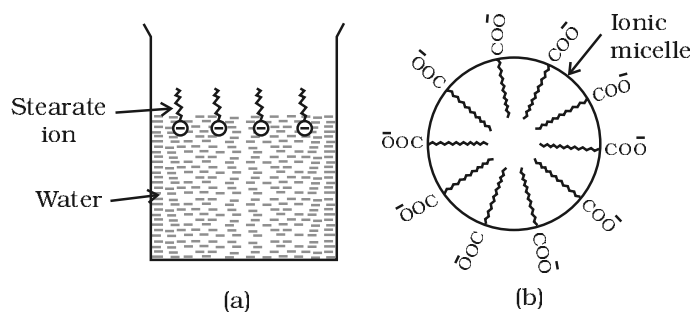

Fig. 5.6: (a) Arrangement of stearate ions on the surface of water at low concentrations of soap
(b) Arrangement of stearate ions inside the bulk of water (ionic micelle) at critical micelle concentrations of soap

The RCOO^- ions are, therefore, present on the surface with their COO^- groups in water and the hydrocarbon chains R staying away from it and remain at the surface. But at critical micelle concentration, the anions are pulled into the bulk of the solution and aggregate to form a spherical shape with their hydrocarbon chains pointing towards the centre of the sphere with COO^- part remaining outward on the surface of the sphere. An aggregate thus formed is known as '**ionic micelle**'. These micelles may contain as many as 100 such ions.

Similarly, in case of detergents, e.g., sodium laurylsulphate, $\text{CH}_3(\text{CH}_2)_{11}\text{SO}_4^-\text{Na}^+$, the polar group is $-\text{SO}_4^-$ along with the long hydrocarbon chain. Hence, the mechanism of micelle formation here also is same as that of soaps.

Cleansing action of soaps

It has been mentioned earlier that a micelle consists of a hydrophobic hydrocarbon – like central core. The cleansing action of soap is due to the

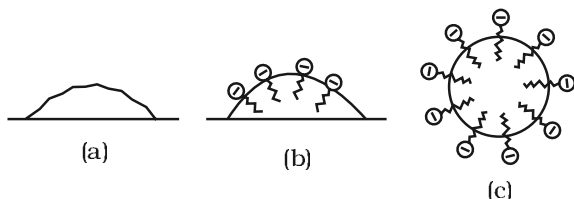

Fig. 5.7: (a) Grease on cloth (b) Stearate ions arranging around the grease droplet and (c) Grease droplet surrounded by stearate ions (micelle formed)

fact that soap molecules form micelle around the oil droplet in such a way that hydrophobic part of the stearate ions is in the oil droplet and hydrophilic part projects out of the grease droplet like the bristles (Fig. 5.7). Since the polar groups can interact with water, the oil droplet surrounded by stearate ions is now pulled in water and removed from the dirty surface. Thus soap helps in emulsification and washing away of oils and fats. The negatively charged sheath around the globules prevents them from coming together and forming aggregates.

5.4.4 Preparation of Colloids

A few important methods for the preparation of colloids are as follows:

(a) Chemical methods

Colloidal solutions can be prepared by chemical reactions leading to formation of molecules by double decomposition, oxidation, reduction or hydrolysis. These molecules then aggregate leading to formation of sols.

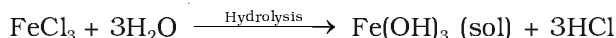
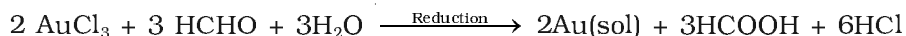
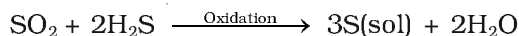
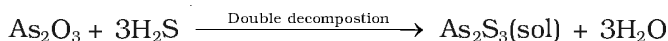

(b) Electrical disintegration or Bredig's Arc method

This process involves dispersion as well as condensation. Colloidal sols of metals such as gold, silver, platinum, etc., can be prepared

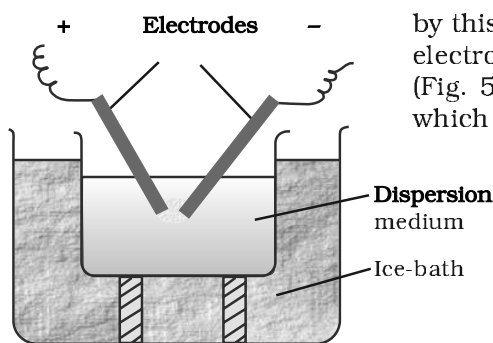

Fig. 5.8: Bredig's Arc method

by this method. In this method, electric arc is struck between electrodes of the metal immersed in the dispersion medium (Fig. 5.8). The intense heat produced vapourises the metal, which then condenses to form particles of colloidal size.

(c) Peptization

Peptization may be defined as the **process of converting a precipitate into colloidal sol** by shaking it with dispersion medium in the presence of a small amount of electrolyte. The electrolyte used for this purpose is called **peptizing agent**. This method is applied, generally, to convert a freshly prepared precipitate into a colloidal sol.

During peptization, the precipitate adsorbs one of the ions of the electrolyte on its surface. This causes the development of positive or negative charge on precipitates, which ultimately break up into smaller particles of the size of a colloid.

5.4.5 Purification of Colloidal Solutions

Colloidal solutions when prepared, generally contain excessive amount of electrolytes and some other soluble impurities. While the presence of traces of electrolyte is essential for the stability of the colloidal solution, larger quantities coagulate it. It is, therefore, necessary to reduce the concentration of these soluble impurities to a requisite minimum. **The process used for reducing the amount of impurities to a requisite minimum is known as purification of colloidal solution.** The purification of colloidal solution is carried out by the following methods:

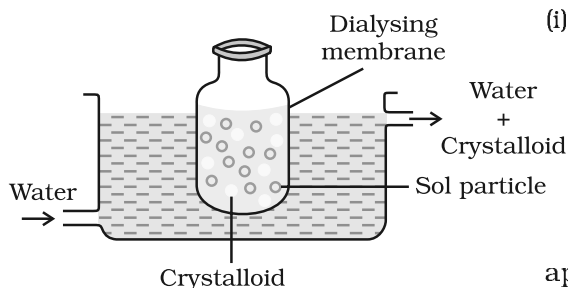

Fig. 5.9: Dialysis

(i) **Dialysis: It is a process of removing a dissolved substance from a colloidal solution by means of diffusion through a suitable membrane.** Since particles (ions or smaller molecules) in a true solution can pass through animal membrane (bladder) or parchment paper or cellophane sheet but not the colloidal particles, the membrane can be used for dialysis. The apparatus used for this purpose is called **dialyser**.

A bag of suitable membrane containing the colloidal solution is suspended in a vessel through which fresh water is continuously flowing (Fig. 5.9). The molecules and ions diffuse through membrane into the outer water and pure colloidal solution is left behind.

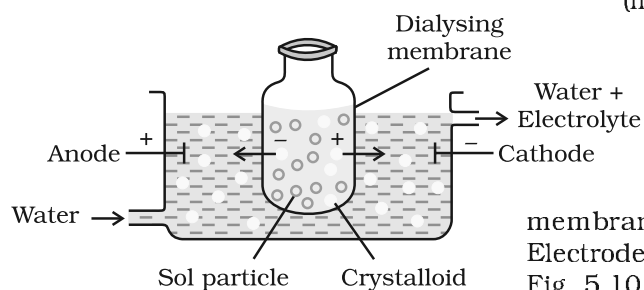

Fig. 5.10: Electro-dialysis

(ii) **Electro-dialysis:** Ordinarily, the process of dialysis is quite slow. It can be made faster by applying an electric field if the dissolved substance in the impure colloidal solution is only an electrolyte. The process is then named electro-dialysis. The colloidal solution is placed in a bag of suitable membrane while pure water is taken outside. Electrodes are fitted in the compartment as shown in Fig. 5.10. The ions present in the colloidal solution migrate out to the oppositely charged electrodes.

- (iii) **Ultrafiltration:** Ultrafiltration is the process of separating the colloidal particles from the solvent and soluble solutes present in the colloidal solution by specially prepared filters, which are permeable to all substances except the colloidal particles. Colloidal particles can pass through ordinary filter paper because the pores are too large. However, the pores of filter paper can be reduced in size by impregnating with **colloidion** solution to stop the flow of colloidal particles. The usual colloidion is a 4% solution of nitrocellulose in a mixture of alcohol and ether. An ultra-filter paper may be prepared by soaking the filter paper in a colloidion solution, hardening by formaldehyde and then finally drying it. Thus, by using ultra-filter paper, the colloidal particles are separated from rest of the materials. Ultrafiltration is a slow process. To speed up the process, pressure or suction is applied. The colloidal particles left on the ultra-filter paper are then stirred with fresh dispersion medium (solvent) to get a pure colloidal solution.

5.4.6 Properties of Colloidal Solutions

Various properties exhibited by the colloidal solutions are described below:

- (i) **Colligative properties:** Colloidal particles being bigger aggregates, the number of particles in a colloidal solution is comparatively small as compared to a true solution. Hence, the values of colligative properties (osmotic pressure, lowering in vapour pressure, depression in freezing point and elevation in boiling point) are of small order as compared to values shown by true solutions at same concentrations.

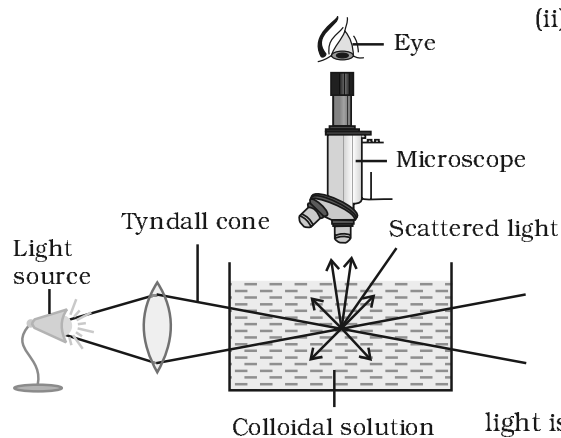

Fig. 5.11: Tyndall effect

- (ii) **Tyndall effect:** If a homogeneous solution placed in dark is observed in the direction of light, it appears clear and, if it is observed from a direction at right angles to the direction of light beam, it appears perfectly dark. Colloidal solutions viewed in the same way may also appear reasonably clear or translucent by the transmitted light but they show a mild to strong opalescence, when viewed at right angles to the passage of light, i.e., the path of the beam is illuminated by a bluish light. This effect was first observed by Faraday and later studied in detail by Tyndall and is termed as **Tyndall effect**. The bright cone of the

light is called **Tyndall cone** (Fig. 5.11). The Tyndall effect is due to the fact that colloidal particles scatter light in all directions in space. This scattering of light illuminates the path of beam in the colloidal dispersion.

Tyndall effect can be observed during the projection of picture in the cinema hall due to scattering of light by dust and smoke particles present there. Tyndall effect is observed only when the following two conditions are satisfied.

- (i) The diameter of the dispersed particles is not much smaller than the wavelength of the light used; and
- (ii) The refractive indices of the dispersed phase and the dispersion medium differ greatly in magnitude.

Tyndall effect is used to distinguish between a colloidal and true solution. Zsigmondy, in 1903, used Tyndall effect to set up an apparatus known as ultramicroscope. An intense beam of light is focussed on the colloidal solution contained in a glass vessel. The focus of the light is then observed with a microscope at right angles to the beam. Individual colloidal particles appear as bright stars against a dark background. Ultramicroscope does not render the actual colloidal particles visible but only observe the light scattered by them. Thus, ultramicroscope does not provide any information about the size and shape of colloidal particles.

(iii) *Colour*: The colour of colloidal solution depends on the wavelength of light scattered by the dispersed particles. The wavelength of light further depends on the size and nature of the particles. The colour of colloidal solution also changes with the manner in which the observer receives the light. For example, a mixture of milk and water appears blue when viewed by the reflected light and red when viewed by the transmitted light. Finest gold sol is red in colour; as the size of particles increases, it appears purple, then blue and finally golden.

(iv) *Brownian movement*: When colloidal solutions are viewed under a powerful ultramicroscope, the colloidal particles appear to be in a state of continuous zig-zag motion all over the field of view. This motion was first observed by the British botanist, Robert Brown, and is known as Brownian movement (Fig. 5.12). This motion is independent of the nature of the colloid but depends on the size of the particles and viscosity of the solution. Smaller the size and lesser the viscosity, faster is the motion.

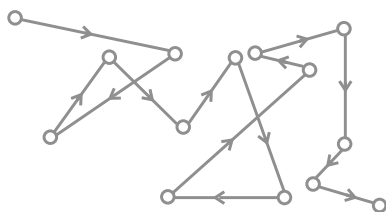

Fig. 5.12: Brownian movement

The Brownian movement has been explained to be due to the unbalanced bombardment of the particles by the molecules of the dispersion medium. The Brownian movement has a stirring effect which does not permit the particles to settle and thus, is responsible for the stability of sols.

(v) *Charge on colloidal particles*: Colloidal particles always carry an electric charge. The nature of this charge is the same on all the particles in a given colloidal solution and may be either positive or negative. A list of some common sols with the nature of charge on their particles is given below:

Positively charged sols	Negatively charged sols
Hydrated metallic oxides, e.g., $\text{Al}_2\text{O}_3 \cdot x\text{H}_2\text{O}$, $\text{CrO}_3 \cdot x\text{H}_2\text{O}$ and $\text{Fe}_2\text{O}_3 \cdot x\text{H}_2\text{O}$, etc.	Metals, e.g., copper, silver, gold sols.
Basic dye stuffs, e.g., methylene blue sol.	Metallic sulphides, e.g., As_2S_3 , Sb_2S_3 , CdS sols.
Haemoglobin (blood)	Acid dye stuffs, e.g., eosin, congo red sols.
Oxides, e.g., TiO_2 sol.	Sols of starch, gum, gelatin, clay, charcoal, etc.

The charge on the sol particles is due to one or more reasons, viz., due to electron capture by sol particles during electrodispersion of metals, due to preferential adsorption of ions from solution and/or due to formulation of electrical double layer.

Preferential adsorption of ions is the most accepted reason. The sol particles acquire positive or negative charge by preferential adsorption of +ve or -ve ions. When two or more ions are present in the dispersion medium, preferential adsorption of the ion common to the colloidal particle usually takes place. This can be explained by taking the following examples:

- (a) When silver nitrate solution is added to potassium iodide solution, the precipitated silver iodide adsorbs iodide ions from the dispersion medium and negatively charged colloidal solution results. However, when KI solution is added to AgNO_3 solution, positively charged sol results due to adsorption of Ag^+ ions from dispersion medium.

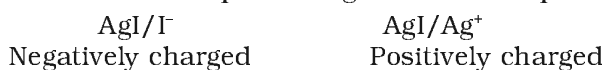

- (b) If FeCl_3 is added to excess of hot water, a positively charged sol of hydrated ferric oxide is formed due to adsorption of Fe^{3+} ions. However, when ferric chloride is added to NaOH a negatively charged sol is obtained with adsorption of OH^- ions.

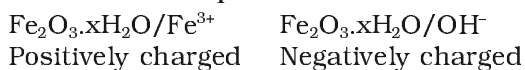

Having acquired a positive or a negative charge by selective adsorption on the surface of a colloidal particle as stated above, this layer attracts counter ions from the medium forming a second layer, as shown below.



The combination of the two layers of opposite charges around the colloidal particle is called Helmholtz electrical double layer. According to modern views, the first layer of ions is firmly held and is termed fixed layer while the second layer is mobile which is termed diffused layer. Since separation of charge is a seat of potential, the charges of opposite signs on the fixed and diffused parts of the double layer results in a difference in potential between these layers. This potential difference between the fixed layer and the diffused layer of opposite charges is called the **electrokinetic potential or zeta potential**.

The presence of equal and similar charges on colloidal particles is largely responsible in providing stability to the colloidal solution, because the repulsive forces between charged particles having same charge prevent them from coalescing or aggregating when they come closer to one another.

- (vi) *Electrophoresis*: The existence of charge on colloidal particles is confirmed by electrophoresis experiment. When electric potential is applied across two platinum electrodes dipping in a colloidal solution, the colloidal particles move towards one or the other electrode. The movement of colloidal particles under an applied electric potential is called electrophoresis. Positively charged particles move towards the cathode while negatively charged

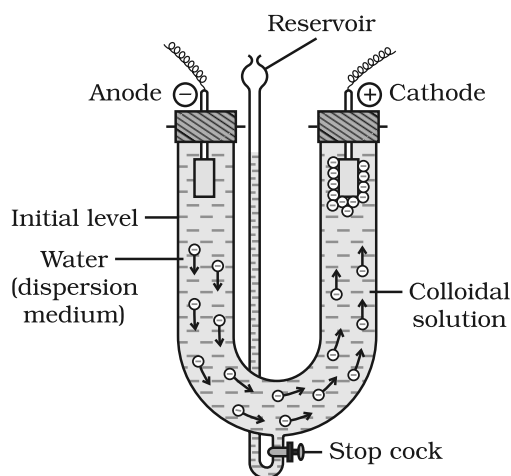

Fig. 5.13: Electrophoresis

particles move towards the anode. This can be demonstrated by the following experimental set-up (Fig. 5.13).

When electrophoresis, i.e., movement of particles is prevented by some suitable means, it is observed that the dispersion medium begins to move in an electric field. This phenomenon is termed **electroosmosis**.

(vii) *Coagulation or precipitation*: The stability of the lyophobic sols is due to the presence of charge on colloidal particles. If, somehow, the charge is removed, the particles will come nearer to each other to form aggregates (or coagulate) and settle down under the force of gravity.

The process of settling of colloidal particles is called coagulation or precipitation of the sol.

The coagulation of the lyophobic sols can be carried out in the following ways:

- (i) *By electrophoresis*: The colloidal particles move towards oppositely charged electrodes, get discharged and precipitated.
- (ii) *By mixing two oppositely charged sols*: Oppositely charged sols when mixed in almost equal proportions, neutralise their charges and get partially or completely precipitated. Mixing of hydrated ferric oxide (+ve sol) and arsenious sulphide (-ve sol) bring them in the precipitated forms. This type of coagulation is called mutual coagulation.
- (iii) *By boiling*: When a sol is boiled, the adsorbed layer is disturbed due to increased collisions with the molecules of dispersion medium. This reduces the charge on the particles and ultimately lead to settling down in the form of a precipitate.
- (iv) *By persistent dialysis*: On prolonged dialysis, traces of the electrolyte present in the sol are removed almost completely and the colloids become unstable and ultimately coagulate.
- (v) *By addition of electrolytes*: When excess of an electrolyte is added, the colloidal particles are precipitated. The reason is that colloids interact with ions carrying charge opposite to that present on themselves. This causes neutralisation leading to their coagulation. The ion responsible for neutralisation of charge on the particles is called the coagulating ion. A negative ion causes the precipitation of positively charged sol and vice versa.

It has been observed that, generally, the greater the valence of the flocculating ion added, the greater is its power to cause precipitation. This is known as Hardy-Schulze rule. In the coagulation of a negative sol, the flocculating power is in the order: $\text{Al}^{3+} > \text{Ba}^{2+} > \text{Na}^+$

Similarly, in the coagulation of a positive sol, the flocculating power is in the order: $[\text{Fe}(\text{CN})_6]^{4-} > \text{PO}_4^{3-} > \text{SO}_4^{2-} > \text{Cl}^-$

The minimum concentration of an electrolyte in millimoles per litre required to cause precipitation of a sol in two hours is called coagulating value. The smaller the quantity needed, the higher will be the coagulating power of an ion.

Coagulation of lyophilic sols

There are two factors which are responsible for the stability of lyophilic sols. These factors are the charge and solvation of the colloidal particles. When these two factors are removed, a lyophilic sol can be coagulated. This is done (i) by adding an electrolyte and (ii) by adding a suitable solvent. When solvents such as alcohol and acetone are added to hydrophilic sols, the dehydration of dispersed phase occurs. Under this condition, a small quantity of electrolyte can bring about coagulation.

Protection of colloids

Lyophilic sols are more stable than lyophobic sols. This is due to the fact that lyophilic colloids are extensively solvated, i.e., colloidal particles are covered by a sheath of the liquid in which they are dispersed.

Lyophilic colloids have a unique property of protecting lyophobic colloids. When a lyophilic sol is added to the lyophobic sol, the lyophilic particles form a layer around lyophobic particles and thus protect the latter from electrolytes. Lyophilic colloids used for this purpose are called protective colloids.

5.5 Emulsions

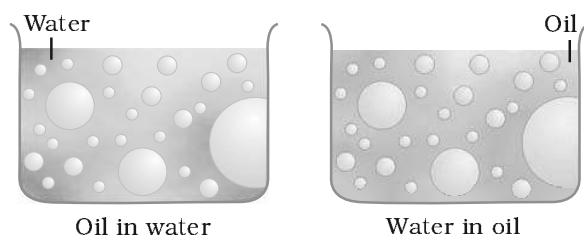

Fig. 5.14: Types of emulsions

These are liquid-liquid colloidal systems, i.e., the dispersion of finely divided droplets in another liquid. If a mixture of two immiscible or partially miscible liquids is shaken, a coarse dispersion of one liquid

in the other is obtained which is called emulsion. Generally, one of the two liquids is water. There are two types of emulsions.

- (i) Oil dispersed in water (O/W type) and
- (ii) Water dispersed in oil (W/O type).

In the first system, water acts as dispersion medium. Examples of this type of emulsion are milk and vanishing cream. In milk, liquid fat is dispersed in water. In the second system, oil acts as dispersion medium. Common examples of this type are butter and cream.

Emulsions of oil in water are unstable and sometimes they separate into two layers on standing. For stabilisation of an emulsion, a third component called emulsifying agent is usually added. The emulsifying agent forms an interfacial film between suspended particles and the medium. The principal emulsifying agents for O/W emulsions are proteins, gums, natural and synthetic soaps, etc., and for W/O, heavy metal salts of fatty acids, long chain alcohols, lampblack, etc.

Emulsions can be diluted with any amount of the dispersion medium. On the other hand, the dispersed liquid when mixed, forms a separate layer. The droplets in emulsions are often negatively charged and can be precipitated by electrolytes. They also show Brownian movement and Tyndall effect. Emulsions can be broken into constituent liquids by heating, freezing, centrifuging, etc.

5.6 Colloids Around Us

Most of the substances, we come across in our daily life, are colloids. The meals we eat, the clothes we wear, the wooden furniture we use, the houses we live in, the newspapers we read, are largely composed of colloids.

Following are the interesting and noteworthy examples of colloids:

- (i) *Blue colour of the sky*: Dust particles along with water suspended in air scatter blue light which reaches our eyes and the sky looks blue to us.
- (ii) *Fog, mist and rain*: When a large mass of air containing dust particles, is cooled below its dewpoint, the moisture from the air condenses on the surfaces of these particles forming fine droplets. These droplets being colloidal in nature continue to float in air in the form of mist or fog. Clouds are aerosols having small droplets of water suspended in air. On account of condensation in the upper atmosphere, the colloidal droplets of water grow bigger and bigger in size, till they come down in the form of rain. Sometimes, the rainfall occurs when two oppositely charged clouds meet.

It is possible to cause artificial rain by throwing electrified sand or spraying a sol carrying charge opposite to the one on clouds from an aeroplane.

- (iii) *Food articles*: Milk, butter, halwa, ice creams, fruit juices, etc., are all colloids in one form or the other.
- (iv) *Blood*: It is a colloidal solution of an albuminoid substance. The styptic action of alum and ferric chloride solution is due to coagulation of blood forming a clot which stops further bleeding.
- (v) *Soils*: Fertile soils are colloidal in nature in which humus acts as a protective colloid. On account of colloidal nature, soils adsorb moisture and nourishing materials.
- (vi) *Formation of delta*: River water is a colloidal solution of clay. Sea water contains a number of electrolytes. When river water meets the sea water, the electrolytes present in sea water coagulate the colloidal solution of clay resulting in its deposition with the formation of delta.

Applications of colloids

Colloids are widely used in the industry. Following are some examples:

- (i) *Electrical precipitation of smoke*: Smoke is a colloidal solution of solid particles such as carbon, arsenic compounds, dust, etc., in air. The smoke, before it comes out from the chimney, is led through a chamber containing plates having a charge opposite to that carried by smoke particles. The particles on coming in contact with these plates lose their charge and get precipitated. The particles thus settle down on the floor of the chamber. The precipitator is called Cottrell precipitator (Fig.5.15).

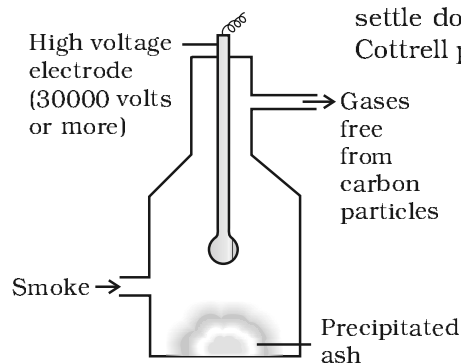

Fig. 5.15: Cottrell smoke precipitator

- (ii) *Purification of drinking water*: The water obtained from natural sources often contains suspended impurities. Alum is added to such water to coagulate the suspended impurities and make water fit for drinking purposes.
- (iii) *Medicines*: Most of the medicines are colloidal in nature. For example, argyrol is a silver sol used as an eye lotion. Colloidal antimony is used in curing kalaazar. Colloidal gold is used for intramuscular injection. Milk of magnesia, an emulsion, is used for stomach disorders. Colloidal medicines are more effective because they have large surface area and are therefore easily assimilated.

- (iv) *Tanning*: Animal hides are colloidal in nature. When a hide, which has positively charged particles, is soaked in tannin, which contains negatively charged colloidal particles, mutual coagulation takes place. This results in the hardening of leather. This process is termed as tanning. Chromium salts are also used in place of tannin.
- (v) *Cleansing action of soaps and detergents*: This has already been described in Section 5.4.3.
- (vi) *Photographic plates and films*: Photographic plates or films are prepared by coating an emulsion of the light sensitive silver bromide in gelatin over glass plates or celluloid films.
- (vii) *Rubber industry*: Latex is a colloidal solution of rubber particles which are negatively charged. Rubber is obtained by coagulation of latex.
- (viii) *Industrial products*: Paints, inks, synthetic plastics, rubber, graphite lubricants, cement, etc., are all colloidal solutions.

Intext Questions

5.7 What modification can you suggest in the Hardy Schulze law?

5.8 Why is it essential to wash the precipitate with water before estimating it quantitatively?

Summary

Adsorption is the phenomenon of attracting and retaining the molecules of a substance on the surface of a solid resulting into a higher concentration on the surface than in the bulk. The substance adsorbed is known as **adsorbate** and the substance on which adsorption takes place is called **adsorbent**. In physisorption, adsorbate is held to the adsorbent by weak van der Waals forces, and in chemisorption, adsorbate is held to the adsorbent by strong chemical bond. Almost all solids adsorb gases. The extent of adsorption of a gas on a solid depends upon nature of gas, nature of solid, surface area of the solid, pressure of gas and temperature of gas. The relationship between the extent of adsorption (x/m) and pressure of the gas at constant temperature is known as **adsorption isotherm**.

A **catalyst** is a substance which enhances the rate of a chemical reaction without itself getting used up in the reaction. The phenomenon using catalyst is known as **catalysis**. In homogeneous catalysis, the catalyst is in the same phase as are the reactants, and in heterogeneous catalysis the catalyst is in a different phase from that of the reactants.

Colloidal solutions are intermediate between true solutions and suspensions. The size of the colloidal particles range from 1 to 1000 nm. A colloidal system consists of two phases - the dispersed phase and the dispersion medium. Colloidal systems are classified in three ways depending upon (i) physical states of the dispersed phase and dispersion medium (ii) nature of interaction between the dispersed phase and dispersion medium and (iii) nature of particles of dispersed phase. The colloidal systems show interesting optical, mechanical and electrical properties. The process of changing the colloidal particles in a sol into the insoluble precipitate by addition of some suitable electrolytes is known as **coagulation**. **Emulsions** are colloidal systems in which both dispersed phase and dispersion medium are liquids. These can be of: (i) **oil in water type** and (ii) **water in oil type**. The process of making emulsion is known as **emulsification**. To stabilise an emulsion, an emulsifying agent or emulsifier is added. Soaps and detergents are most frequently used as emulsifiers. Colloids find several applications in industry as well as in daily life.

Exercises

- 5.1** Distinguish between the meaning of the terms adsorption and absorption. Give one example of each.
- 5.2** What is the difference between physisorption and chemisorption?
- 5.3** Give reason why a finely divided substance is more effective as an adsorbent.
- 5.4** What are the factors which influence the adsorption of a gas on a solid?
- 5.5** What is an adsorption isotherm? Describe Freundlich adsorption isotherm.
- 5.6** What do you understand by activation of adsorbent? How is it achieved?
- 5.7** What role does adsorption play in heterogeneous catalysis?
- 5.8** Why is adsorption always exothermic ?
- 5.9** How are the colloidal solutions classified on the basis of physical states of the dispersed phase and dispersion medium?
- 5.10** Discuss the effect of pressure and temperature on the adsorption of gases on solids.
- 5.11** What are lyophilic and lyophobic sols? Give one example of each type. Why are hydrophobic sols easily coagulated ?
- 5.12** What is the difference between multimolecular and macromolecular colloids? Give one example of each. How are associated colloids different from these two types of colloids?
- 5.13** What are enzymes ? Write in brief the mechanism of enzyme catalysis.
- 5.14** How are colloids classified on the basis of
- (i) physical states of components
 - (ii) nature of dispersion medium and
 - (iii) interaction between dispersed phase and dispersion medium?
- 5.15** Explain what is observed
- (i) when a beam of light is passed through a colloidal sol.
 - (ii) an electrolyte, NaCl is added to hydrated ferric oxide sol.
 - (iii) electric current is passed through a colloidal sol?
- 5.16** What are emulsions? What are their different types? Give example of each type.
- 5.17** What is demulsification? Name two demulsifiers.
- 5.18** Action of soap is due to emulsification and micelle formation. Comment.
- 5.19** Give four examples of heterogeneous catalysis.
- 5.20** What do you mean by activity and selectivity of catalysts?
- 5.21** Describe some features of catalysis by zeolites.
- 5.22** What is shape selective catalysis?
- 5.23** Explain the following terms:
- (i) Electrophoresis
 - (ii) Coagulation
 - (iii) Dialysis
 - (iv) Tyndall effect.
- 5.24** Give four uses of emulsions.
- 5.25** What are micelles? Give an example of a micellers system.
- 5.26** Explain the terms with suitable examples:
- (i) Alcosol
 - (ii) Aerosol
 - (iii) Hydrosol.
- 5.27** Comment on the statement that "colloid is not a substance but a state of substance".

Unit

6

General Principles and Processes of Isolation of Elements

Objectives

After studying this Unit, you will be able to

- explain the terms minerals, ores, concentration, benefaction, calcination, roasting, refining, etc.;
- understand the principles of oxidation and reduction as applied to the extraction procedures;
- apply the thermodynamic concepts like that of Gibbs energy and entropy to the principles of extraction of Al, Cu, Zn and Fe;
- explain why reduction of certain oxides like Cu_2O is much easier than that of Fe_2O_3 ;
- explain why CO is a favourable reducing agent at certain temperatures while coke is better in some other cases;
- explain why specific reducing agents are used for the reduction purposes.

Thermodynamics illustrates why only a certain reducing element and a minimum specific temperature are suitable for reduction of a metal oxide to the metal in an extraction.

A few elements like carbon, sulphur, gold and noble gases, occur in free state while others in combined forms in the earth's crust. The extraction and isolation of an element from its combined form involves various principles of chemistry. A particular element may occur in a variety of compounds. The process of metallurgy and isolation should be such that it is chemically feasible and commercially viable. Still, some general principles are common to all the extraction processes of metals. For obtaining a particular metal, first we look for **minerals** which are naturally occurring chemical substances in the earth's crust obtainable by mining. Out of many minerals in which a metal may be found, only a few are viable to be used as sources of that metal. Such minerals are known as **ores**.

Rarely, an ore contains only a desired substance. It is usually contaminated with earthly or undesired materials known as **gangue**. The extraction and isolation of metals from ores involve the following major steps:

- Concentration of the ore,
- Isolation of the metal from its concentrated ore, and
- Purification of the metal.

The entire scientific and technological process used for isolation of the metal from its ores is known as **metallurgy**.

6.1 Occurrence of Metals

In the present Unit, first we shall describe various steps for effective concentration of ores. After that we shall discuss the principles of some of the common metallurgical processes. Those principles shall include the thermodynamic and electrochemical aspects involved in the effective reduction of the concentrated ore to the metal.

Elements vary in abundance. Among metals, aluminium is the most abundant. It is the third most abundant element in earth's crust (8.3% approx. by weight). It is a major component of many igneous minerals including mica and clays. Many gemstones are impure forms of Al_2O_3 and the impurities range from Cr (in 'ruby') to Co (in 'sapphire'). Iron is the second most abundant metal in the earth's crust. It forms a variety of compounds and their various uses make it a very important element. It is one of the essential elements in biological systems as well.

The principal ores of aluminium, iron, copper and zinc have been given in Table 6.1.

Table 6.1: Principal Ores of Some Important Metals

Metal	Ores	Composition
Aluminium	Bauxite	$\text{AlO}_x(\text{OH})_{3-2x}$ [where $0 < x < 1$]
	Kaolinite (a form of clay)	$[\text{Al}_2(\text{OH})_4\text{Si}_2\text{O}_5]$
Iron	Haematite	Fe_2O_3
	Magnetite	Fe_3O_4
	Siderite	FeCO_3
	Iron pyrites	FeS_2
Copper	Copper pyrites	CuFeS_2
	Malachite	$\text{CuCO}_3 \cdot \text{Cu}(\text{OH})_2$
	Cuprite	Cu_2O
	Copper glance	Cu_2S
Zinc	Zinc blende or Sphalerite	ZnS
	Calamine	ZnCO_3
	Zincite	ZnO

For the purpose of extraction, bauxite is chosen for aluminium. For iron, usually the oxide ores which are abundant and do not produce polluting gases (like SO_2 that is produced in case iron pyrites) are taken. For copper and zinc, any of the listed ores (Table 6.1) may be used depending upon availability and other relevant factors. Before proceeding for concentration, ores are graded and crushed to reasonable size.

6.2 Concentration of Ores

Removal of the unwanted materials (e.g., sand, clays, etc.) from the ore is known as *concentration*, *dressing* or *benefaction*. It involves several steps and selection of these steps depends upon the differences in physical properties of the compound of the metal present and that of the *gangue*. The type of the metal, the available facilities and the environmental factors are also taken into consideration. Some of the important procedures are described below.

6.2.1 Hydraulic Washing

This is based on the differences in gravities of the ore and the *gangue* particles. It is therefore a type of *gravity separation*. In one such process,

an upward stream of running water is used to wash the powdered ore. The lighter gangue particles are washed away and the heavier ores are left behind.

6.2.2 Magnetic Separation

This is based on differences in magnetic properties of the ore components. If either the ore or the gangue (one of these two) is capable of being attracted by a magnetic field, then such separations are carried out (e.g., in case of iron ores). The ground ore is carried on a conveyor belt which passes over a magnetic roller (Fig.6.1).

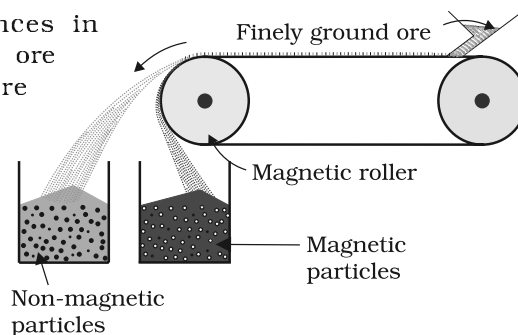
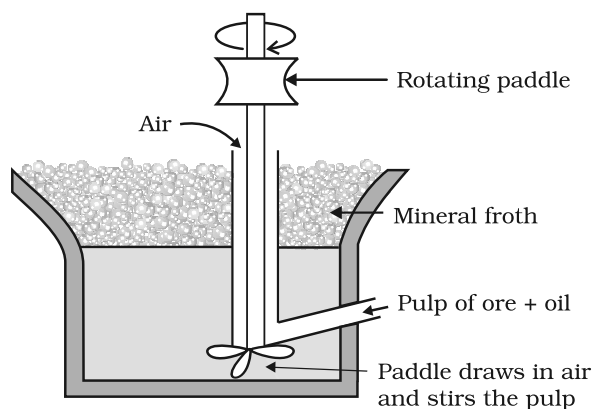

Fig. 6.1: Magnetic separation (schematic)

6.2.3 Froth Floatation Method

This method has been in use for removing gangue from sulphide ores. In this process, a suspension of the powdered ore is made with water. To it, collectors and froth stabilisers are added. Collectors (e. g., pine oils, fatty acids, xanthates, etc.) enhance non-wettability of the mineral particles and froth stabilisers (e. g., cresols, aniline) stabilise the froth.



Enlarged view of an air bubble showing mineral particles attached to it

Fig. 6.2: Froth floatation process (schematic)

The mineral particles become wet by oils while the gangue particles by water. A rotating paddle agitates the mixture and draws air in it. As a result, froth is formed which carries the mineral particles. The froth is light and is skimmed off. It is then dried for recovery of the ore particles.

Sometimes, it is possible to separate two sulphide ores by adjusting proportion of oil to water or by using 'depressants'. For example, in case of an ore containing ZnS and PbS, the depressant used is NaCN. It selectively prevents ZnS from coming to the froth but allows PbS to come with the froth.

The Innovative Washerwoman

One can do wonders if he or she has a scientific temperament and is attentive to observations. A washerwoman had an innovative mind too. While washing a miner's overalls, she noticed that sand and similar dirt fell to the bottom of the washtub. What was peculiar, the copper bearing compounds that had come to the clothes from the mines, were caught in the soapsuds and so they came to the top. One of her clients was a chemist, Mrs. Carrie Everson. The washerwoman told her experience to Mrs. Everson. The latter thought that the idea could be used for separating copper compounds from rocky and earth materials on large scale. This way an invention was born. At that time only those ores were used for extraction of copper, which contained large amounts of the metal. Invention of the *Froth Floatation Method* made copper mining profitable even from the low-grade ores. World production of copper soared and the metal became cheaper.

6.2.4 Leaching

Leaching is often used if the ore is soluble in some suitable solvent. The following examples illustrate the procedure:

(a) Leaching of alumina from bauxite

The principal ore of aluminium, bauxite, usually contains SiO_2 , iron oxides and titanium oxide (TiO_2) as impurities. Concentration is carried out by digesting the powdered ore with a concentrated solution of NaOH at 473 – 523 K and 35 – 36 bar pressure. This way, Al_2O_3 is leached out as sodium aluminate (and SiO_2 too as sodium silicate) leaving the impurities behind:

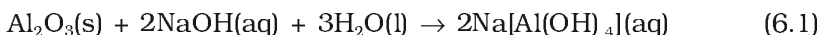

The aluminate in solution is neutralised by passing CO_2 gas and hydrated Al_2O_3 is precipitated. At this stage, the solution is seeded with freshly prepared samples of hydrated Al_2O_3 which induces the precipitation:

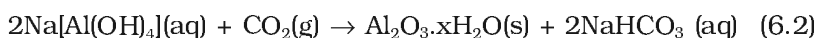

The sodium silicate remains in the solution and hydrated alumina is filtered, dried and heated to give back pure Al_2O_3 :

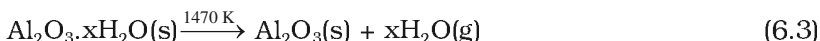

(b) Other examples

In the metallurgy of silver and that of gold, the respective metal is leached with a dilute solution of NaCN or KCN in the presence of air (for O_2) from which the metal is obtained later by replacement:

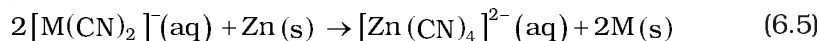
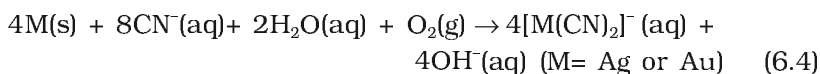

Intext Questions

- 6.1** Which of the ores mentioned in Table 6.1 can be concentrated by magnetic separation method?
- 6.2** What is the significance of leaching in the extraction of aluminium?

6.3 Extraction of Crude Metal from Concentrated Ore

The concentrated ore must be converted into a form which is suitable for reduction. Usually the sulphide ore is converted to oxide before reduction. Oxides are easier to reduce (for the reason see box). Thus isolation of metals from concentrated ore involves two major steps *viz.*,

- (a) conversion to oxide, and
(b) reduction of the oxide to metal.

(a) Conversion to oxide

- (i) **Calcination:** Calcination involves heating when the volatile matter escapes leaving behind the metal oxide:

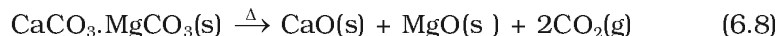
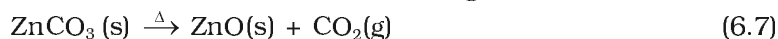
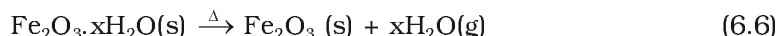

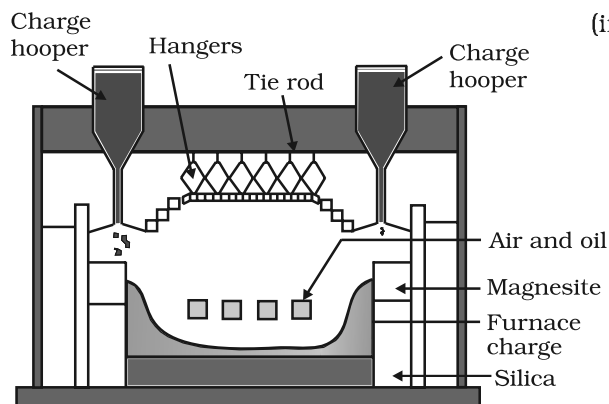
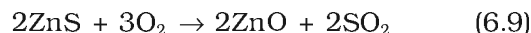
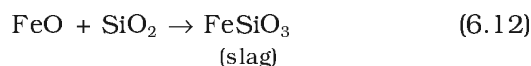

Fig. 6.3: A section of a modern reverberatory furnace

(ii) **Roasting:** In roasting, the ore is heated in a regular supply of air in a furnace at a temperature below the melting point of the metal. Some of the reactions involving sulphide ores are:



The sulphide ores of copper are heated in reverberatory furnace. If the ore contains iron, it is mixed with silica before heating. Iron oxide 'slags of*' as iron silicate and copper is produced in the form of *copper matte* which contains Cu_2S and FeS .



The SO_2 produced is utilised for manufacturing H_2SO_4 .

(b) Reduction of oxide to the metal

Reduction of the metal oxide usually involves heating it with some other substance acting as a reducing agent (C or CO or even another metal). The reducing agent (e.g., carbon) combines with the oxygen of the metal oxide.



Some metal oxides get reduced easily while others are very difficult to be reduced (reduction means electron gain or electronation). In any case, heating is required. To understand the variation in the temperature requirement for thermal reductions (*pyrometallurgy*) and to predict which element will suit as the reducing agent for a given metal oxide (M_xO_y), Gibbs energy interpretations are made.

6.4
Thermodynamic
Principles of
Metallurgy

Some basic concepts of thermodynamics help us in understanding the theory of metallurgical transformations. Gibbs energy is the most significant term here. The change in Gibbs energy, ΔG for any process at any specified temperature, is described by the equation:

$$\Delta G = \Delta H - T\Delta S \quad (6.14)$$

where, ΔH is the enthalpy change and ΔS is the entropy change for the process. For any reaction, this change could also be explained through the equation:

$$\Delta G^\ominus = -RT\ln K \quad (6.15)$$

where, K is the equilibrium constant of the 'reactant - product' system at the temperature, T . A negative ΔG implies a +ve K in equation 6.15. And this can happen only when reaction proceeds towards products. From these facts we can make the following conclusions:

* During metallurgy, 'flux' is added which combines with 'gangue' to form 'slag'. Slag separates more easily from the ore than the gangue. This way, removal of gangue becomes easier.

1. When the value of ΔG is negative in equation 6.14, only then the reaction will proceed. If ΔS is positive, on increasing the temperature (T), the value of $T\Delta S$ would increase ($\Delta H < T\Delta S$) and then ΔG will become $-ve$.
2. If reactants and products of two reactions are put together in a system and the net ΔG of the two possible reactions is $-ve$, the overall reaction will occur. So the process of interpretation involves coupling of the two reactions, getting the sum of their ΔG and looking for its magnitude and *sign*. Such coupling is easily understood through Gibbs energy (ΔG^\ominus) vs T plots for formation of the oxides (Fig. 6.4).

Ellingham Diagram

The graphical representation of Gibbs energy was first used by H.J.T.Ellingham. This provides a sound basis for considering the choice of reducing agent in the reduction of oxides. This is known as Ellingham Diagram. Such diagrams help us in predicting the feasibility of thermal reduction of an ore. The criterion of feasibility is that at a given temperature, Gibbs energy of the reaction must be negative.

- (a) Ellingham diagram normally consists of plots of $\Delta_f G^\ominus$ vs T for formation of oxides of elements i.e., for the reaction,

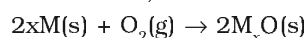

In this reaction, the gaseous amount (hence molecular randomness) is decreasing from left to right due to the consumption of gases leading to a $-ve$ value of ΔS which changes the sign of the second term in equation (6.14). Subsequently ΔG shifts towards higher side despite rising T (normally, ΔG decreases i.e., goes to lower side with increasing temperature). The result is $+ve$ slope in the curve for most of the reactions shown above for formation of $M_xO(s)$.

- (b) Each plot is a straight line except when some change in phase ($s \rightarrow liq$ or $liq \rightarrow g$) takes place. The temperature at which such change occurs, is indicated by an increase in the slope on $+ve$ side (e.g., in the Zn, ZnO plot, the melting is indicated by an abrupt change in the curve).
- (c) There is a point in a curve below which ΔG is negative (So M_xO is stable). Above this point, M_xO will decompose on its own.
- (d) In an Ellingham diagram, the plots of ΔG^\ominus for oxidation (and therefore reduction of the corresponding species) of common metals and some reducing agents are given. The values of $\Delta_f G^\ominus$, etc. (for formation of oxides) at different temperatures are depicted which make the interpretation easy.
- (e) Similar diagrams are also constructed for sulfides and halides and it becomes clear why reductions of M_xS is difficult. There, the $\Delta_f G^\ominus$ of M_xS is not compensated.

Limitations of Ellingham Diagram

1. The graph simply indicates whether a reaction is possible or not i.e., the tendency of reduction with a reducing agent is indicated. This is so because it is based only on the thermodynamic concepts. It does not say about the kinetics of the reduction process (Cannot answer questions like how fast it could be ?).
2. The interpretation of ΔG^\ominus is based on K ($\Delta G^\ominus = -RT \ln K$). Thus it is presumed that the reactants and products are in equilibrium:

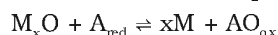

This is not always true because the reactant/product may be solid. [However it explains how the reactions are sluggish when every species is in solid state and smooth when

the ore melts down. It is interesting to note here that ΔH (enthalpy change) and the ΔS (entropy change) values for any chemical reaction remain nearly constant even on varying temperature. So the only dominant variable in equation (6.14) becomes T . However, ΔS depends much on the physical state of the compound. Since entropy depends on disorder or randomness in the system, it will increase if a compound melts ($s \rightarrow l$) or vapourises ($l \rightarrow g$) since molecular randomness increases on changing the phase from solid to liquid or from liquid to gas].

The reducing agent forms its oxide when the metal oxide is reduced. The role of reducing agent is to provide ΔG^\ominus negative and large enough to make the sum of ΔG^\ominus of the two reactions (oxidation of the reducing agent and reduction of the metal oxide) negative.

As we know, during reduction, the oxide of a metal decomposes:

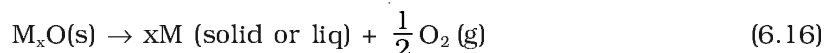

The reducing agent takes away the oxygen. Equation 6.16 can be visualised as reverse of the oxidation of the metal. And then, the $\Delta_r G^\ominus$ value is written in the usual way:

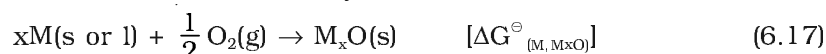

If reduction is being carried out through equation 6.16, the oxidation of the reducing agent (e.g., C or CO) will be there:



If carbon is taken, there may also be complete oxidation of the element to CO_2 :



On subtracting equation 6.17 [it means adding its negative or the reverse form as in equation 6.16] from one of the three equations, we get:

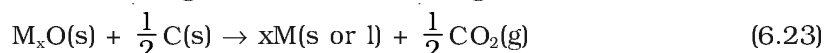
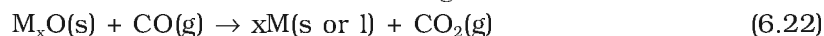

These reactions describe the actual reduction of the metal oxide, M_xO that we want to accomplish. The $\Delta_r G^\ominus$ values for these reactions in general, can be obtained by similar subtraction of the corresponding $\Delta_f G^\ominus$ values.

As we have seen, heating (i.e., increasing T) favours a negative value of $\Delta_r G^\ominus$. Therefore, the temperature is chosen such that the sum of $\Delta_r G^\ominus$ in the two combined redox process is negative. In $\Delta_r G^\ominus$ vs T plots, this is indicated by the point of intersection of the two curves (curve for M_xO and that for the oxidation of the reducing substance). After that point, the $\Delta_r G^\ominus$ value becomes more negative for the combined process including the reduction of M_xO . The difference in the two $\Delta_r G^\ominus$ values after that point determines whether reductions of the oxide of the upper line is feasible by the element represented by the lower line. If the difference is large, the reduction is easier.

Example 6.1 Suggest a condition under which magnesium could reduce alumina.

Solution The two equations are:

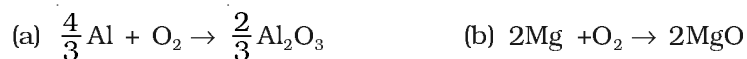

At the point of intersection of the Al_2O_3 and MgO curves (marked "A" in diagram 6.4), the ΔG^\ominus becomes ZERO for the reaction:

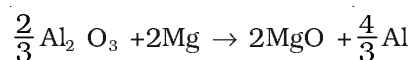

Above that point magnesium can reduce alumina.

Example 6.2 Although thermodynamically feasible, in practice, magnesium metal is not used for the reduction of alumina in the metallurgy of aluminium. Why?

Solution Temperatures above the point of intersection of Al_2O_3 and MgO curves, magnesium can reduce alumina. But the temperature required would be so high that the process will be uneconomic and technologically difficult.

Example 6.3 Why is the reduction of a metal oxide easier if the metal formed is in liquid state at the temperature of reduction?

Solution The entropy is higher if the metal is in liquid state than when it is in solid state. The value of entropy change (ΔS) of the reduction process is more on +ve side when the metal formed is in liquid state and the metal oxide being reduced is in solid state. Thus the value of ΔG^\ominus becomes more on negative side and the reduction becomes easier.

6.4.1 Applications (a) Extraction of iron from its oxides

Oxide ores of iron, after concentration through calcination/roasting (to remove water, to decompose carbonates and to oxidise sulphides) are mixed with limestone and coke and fed into a *Blast furnace* from its top. Here, the oxide is reduced to the metal. Thermodynamics helps us to understand how coke reduces the oxide and why this furnace is chosen. One of the main reduction steps in this process is:

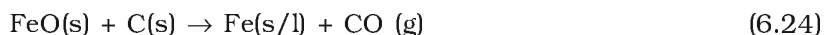

It can be seen as a couple of two simpler reactions. In one, the reduction of FeO is taking place and in the other, C is being oxidised to CO :

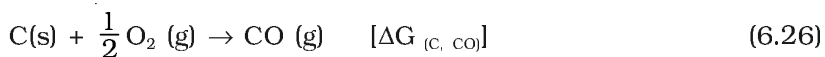
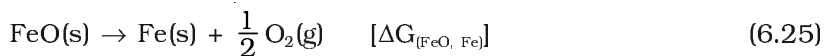

When both the reactions take place to yield the equation (6.23), the net Gibbs energy change becomes:



Naturally, the resultant reaction will take place when the right hand side in equation 6.27 is negative. In ΔG^\ominus vs T plot representing reaction 6.25, the plot goes upward and that representing the change $\text{C} \rightarrow \text{CO}$

(C,CO) goes downward. At temperatures above 1073K (approx.), the C,CO line comes below the Fe,FeO line [$\Delta G_{(C, CO)} < \Delta G_{(Fe, FeO)}$]. So in this range, coke will be reducing the FeO and will itself be oxidised to CO. In a similar way the reduction of Fe_3O_4 and Fe_2O_3 at relatively lower temperatures by CO can be explained on the basis of lower lying points of intersection of their curves with the CO, CO_2 curve in Fig. 6.4.

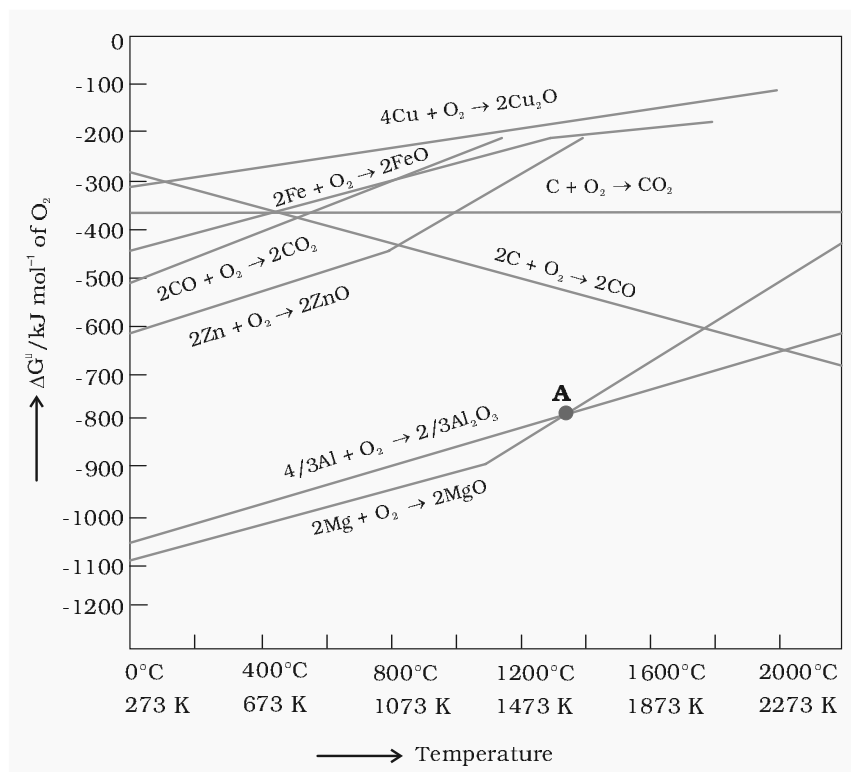
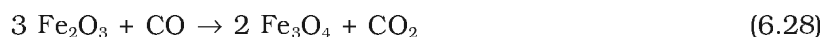

Fig. 6.4: Gibbs energy (ΔG^\ominus) vs T plots (schematic) for formation of some oxides (Ellingham diagram)

In the Blast furnace, reduction of iron oxides takes place in different temperature ranges. Hot air is blown from the bottom of the furnace and coke is burnt to give temperature upto about 2200K in the lower portion itself. The burning of coke therefore supplies most of the heat required in the process. The CO and heat moves to upper part of the furnace. In upper part, the temperature is lower and the iron oxides (Fe_2O_3 and Fe_3O_4) coming from the top are reduced in steps to FeO. Thus, the reduction reactions taking place in the lower temperature range and in the higher temperature range, depend on the points of corresponding intersections in the $\Delta_r G^\ominus$ vs T plots. These reactions can be summarised as follows:

At 500 – 800 K (lower temperature range in the blast furnace)–



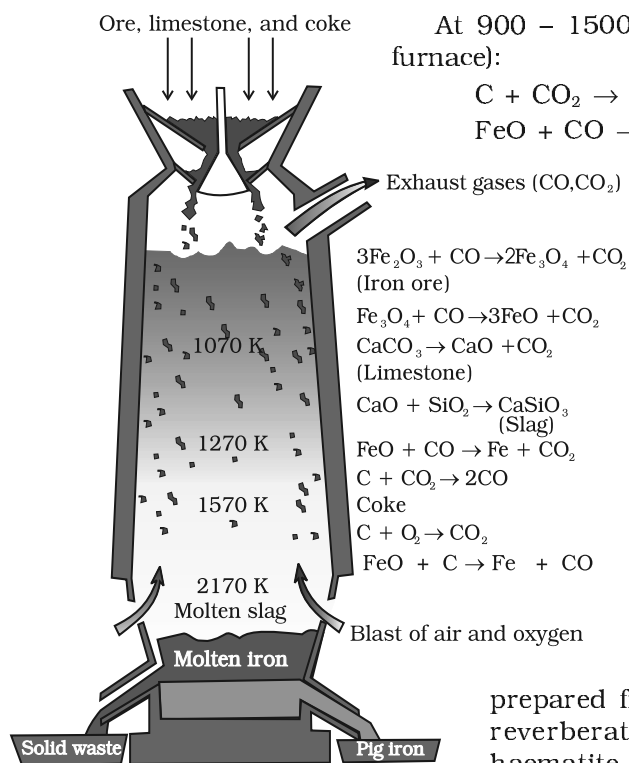

Fig. 6.5: Blast furnace

At 900 – 1500 K (higher temperature range in the blast furnace):



Limestone is also decomposed to CaO which removes silicate impurity of the ore as slag. The slag is in molten state and separates out from iron.

The iron obtained from Blast furnace contains about 4% carbon and many impurities in smaller amount (e.g., S, P, Si, Mn). This is known as *pig iron* and cast into variety of shapes. *Cast iron* is different from *pig iron* and is made by melting pig iron with scrap iron and coke using hot air blast. It has slightly lower carbon content (about 3%) and is extremely hard and brittle.

Further Reductions

Wrought iron or malleable iron is the purest form of commercial iron and is prepared from cast iron by oxidising impurities in a reverberatory furnace lined with haematite. This haematite oxidises carbon to carbon monoxide:



Limestone is added as a flux and sulphur, silicon and phosphorus are oxidised and passed into the slag. The metal is removed and freed from the slag by passing through rollers.

(b) Extraction of copper from cuprous oxide [copper(I) oxide]

In the graph of $\Delta_r G^\ominus$ vs T for formation of oxides (Fig. 6.4), the Cu_2O line is almost at the top. So it is quite easy to reduce oxide ores of copper directly to the metal by heating with coke (both the lines of C, CO and C, CO_2 are at much lower positions in the graph particularly after 500 – 600K). However most of the ores are sulphide and some may also contain iron. The sulphide ores are roasted/smelted to give oxides:

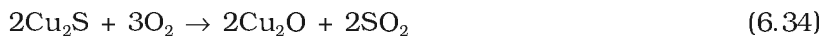

The oxide can then be easily reduced to metallic copper using coke:



In actual process, the ore is heated in a reverberatory furnace after mixing with silica. In the furnace, iron oxide 'slags off' as iron silicate and copper is produced in the form of *copper matte*. This contains Cu_2S and FeS.



Copper matte is then charged into silica lined convertor. Some silica is also added and hot air blast is blown to convert the remaining

FeS₂, FeO and Cu₂S/Cu₂O to the metallic copper. Following reactions take place:

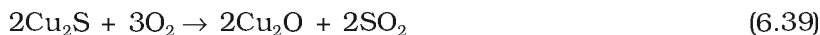
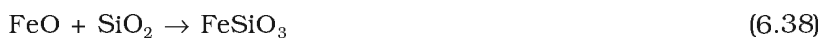

The solidified copper obtained has blistered appearance due to the evolution of SO₂ and so it is called *blister copper*.

(c) Extraction of zinc from zinc oxide

The reduction of zinc oxide is done using coke. The temperature in this case is higher than that in case of copper. For the purpose of heating, the oxide is made into brickettes with coke and clay.



The metal is distilled off and collected by rapid chilling.

Intext Questions

6.3 The reaction,

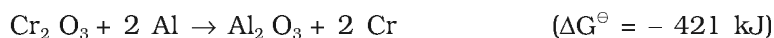

is thermodynamically feasible as is apparent from the Gibbs energy value. Why does it not take place at room temperature?

6.4 Is it true that under certain conditions, Mg can reduce SiO₂ and Si can reduce MgO? What are those conditions?

6.5
*Electrochemical
Principles of
Metallurgy*

We have seen how principles of thermodynamics are applied to pyrometallurgy. Similar principles are effective in the reductions of metal ions in solution or molten state. Here they are reduced by electrolysis or by adding some reducing element.

In the reduction of a molten metal salt, electrolysis is done. Such methods are based on electrochemical principles which could be understood through the equation,

$$\Delta G^\ominus = -nE^\ominus F \quad (6.42)$$

here *n* is the number of electrons and *E*[⊖] is the electrode potential of the redox couple formed in the system. More reactive metals have large negative values of the electrode potential. So their reduction is difficult. If the difference of two *E*[⊖] values corresponds to a positive *E*[⊖] and consequently negative ΔG^\ominus in equation 6.42, then the less reactive metal will come out of the solution and the more reactive metal will go to the solution, e.g.,

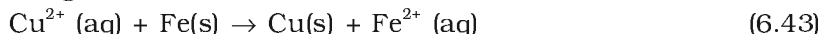

In simple electrolysis, the Mⁿ⁺ ions are discharged at negative electrodes (cathodes) and deposited there. Precautions are taken considering the reactivity of the metal produced and suitable materials are used as electrodes. Sometimes a flux is added for making the molten mass more conducting.

Aluminium

In the metallurgy of aluminium, purified Al_2O_3 is mixed with Na_3AlF_6 or CaF_2 which lowers the melting point of the mix and brings conductivity. The fused matrix is electrolysed. Steel cathode and graphite anode are used. The graphite anode is useful here for reduction to the metal. The overall reaction may be taken as:

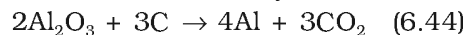

This process of electrolysis is widely known as *Hall-Heroult* process.

The electrolysis of the molten mass is carried out in an electrolytic cell using carbon electrodes. The oxygen liberated at anode reacts with the carbon of anode

producing CO and CO_2 . This way for each kg of aluminium produced, about 0.5 kg of carbon anode is burnt away. The electrolytic reactions are:

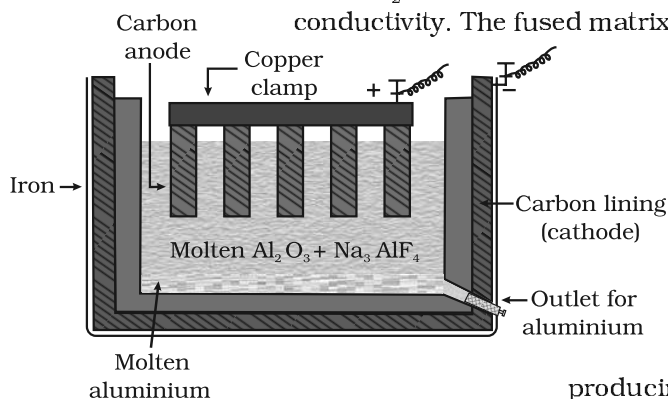
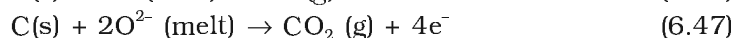
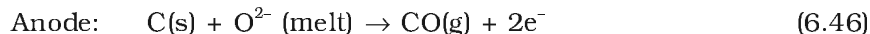
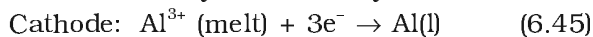
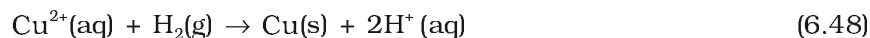

Fig. 6.6: Electrolytic cell for the extraction of aluminium

Copper from Low Grade Ores and Scraps

Copper is extracted by *hydrometallurgy* from low grade ores. It is leached out using acid or bacteria. The solution containing Cu^{2+} is treated with scrap iron or H_2 (equations 6.42; 6.48).



Example 6.4

At a site, low grade copper ores are available and zinc and iron scraps are also available. Which of the two scraps would be more suitable for reducing the leached copper ore and why?

Solution

Zinc being above iron in the electrochemical series (more reactive metal is zinc), the reduction will be faster in case zinc scraps are used. But zinc is costlier metal than iron so using iron scraps will be advisable and advantageous.

6.6 Oxidation Reduction

Besides reductions, some extractions are based on oxidation particularly for non-metals. A very common example of extraction based on oxidation is the extraction of chlorine from brine (chlorine is abundant in sea water as common salt) .

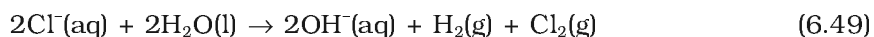

The ΔG^\ominus for this reaction is + 422 kJ. When it is converted to E^\ominus (using $\Delta G^\ominus = -nE^\ominus F$), we get $E^\ominus = -2.2$ V. Naturally, it will require an external e.m.f. that is greater than 2.2 V. But the electrolysis requires an excess potential to overcome some other hindering reactions. Thus, Cl_2 is obtained by electrolysis giving out H_2 and aqueous NaOH as by-products. Electrolysis of molten NaCl is also carried out. But in that case, Na metal is produced and not NaOH .

As studied earlier, extraction of gold and silver involves leaching the metal with CN^- . This is also an oxidation reaction ($\text{Ag} \rightarrow \text{Ag}^+$ or $\text{Au} \rightarrow \text{Au}^+$). The metal is later recovered by displacement method.

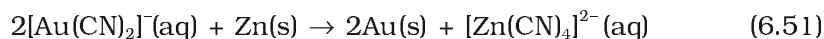
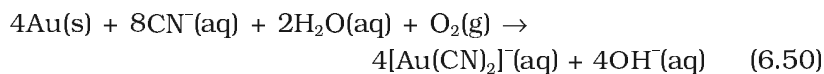

In this reaction zinc acts as a reducing agent.

6.7 Refining

A metal extracted by any method is usually contaminated with some impurity. For obtaining metals of high purity, several techniques are used depending upon the differences in properties of the metal and the impurity. Some of them are listed below.

- | | |
|---------------------------|-----------------------------|
| (a) Distillation | (b) Liquation |
| (c) Electrolysis | (d) Zone refining |
| (e) Vapour phase refining | (f) Chromatographic methods |

These are described in detail here.

(a) Distillation

This is very useful for low boiling metals like zinc and mercury. The impure metal is evaporated to obtain the pure metal as distillate.

(b) Liquation

In this method a low melting metal like tin can be made to flow on a sloping surface. In this way it is separated from higher melting impurities.

(c) Electrolytic refining

In this method, the impure metal is made to act as anode. A strip of the same metal in pure form is used as cathode. They are put in a suitable electrolytic bath containing soluble salt of the same metal. The more basic metal remains in the solution and the less basic ones go to the anode mud. This process is also explained using the concept of electrode potential, over potential, and Gibbs energy which you have seen in previous sections. The reactions are:



Copper is refined using an electrolytic method. Anodes are of impure copper and pure copper strips are taken as cathode. The electrolyte is acidified solution of copper sulphate and the net result of electrolysis is the transfer of copper in pure form from the anode to the cathode:

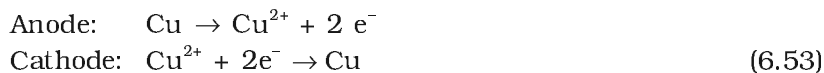

Impurities from the blister copper deposit as anode mud which contains antimony, selenium, tellurium, silver, gold and platinum; recovery of these elements may meet the cost of refining.

Zinc may also be refined this way.

(d) Zone refining

This method is based on the principle that the impurities are more soluble in the melt than in the solid state of the metal. A circular mobile heater is fixed at one end of a rod of the impure metal (Fig. 6.7). The molten zone moves along with the heater which is moved forward. As the heater moves forward, the pure metal crystallises out of the melt and the impurities pass on into the adjacent molten zone. The process is repeated several times and the heater is moved in the same direction. At one end, impurities get concentrated. This end is cut off. This method is very useful for producing semiconductor and other metals of very high purity, e.g., germanium, silicon, boron, gallium and indium.

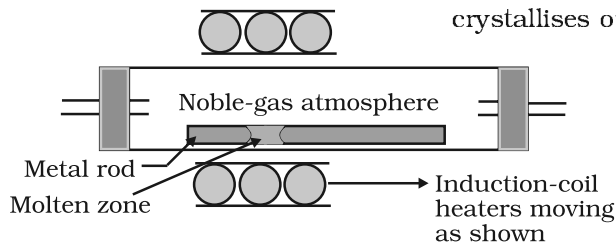

Fig. 6.7: Zone refining process

(e) Vapour phase refining

In this method, the metal is converted into its volatile compound and collected elsewhere. It is then decomposed to give pure metal. So, the two requirements are:

- (i) the metal should form a volatile compound with an available reagent,
- (ii) the volatile compound should be easily decomposable, so that the recovery is easy.

Following examples will illustrate this technique.

Mond Process for Refining Nickel: In this process, nickel is heated in a stream of carbon monoxide forming a volatile complex, nickel tetracarbonyl:



The carbonyl is subjected to higher temperature so that it is decomposed giving the pure metal:

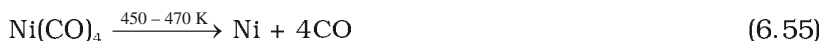

van Arkel Method for Refining Zirconium or Titanium: This method is very useful for removing all the oxygen and nitrogen present in the form of impurity in certain metals like Zr and Ti. The crude metal is heated in an evacuated vessel with iodine. The metal iodide being more covalent, volatilises:



The metal iodide is decomposed on a tungsten filament, electrically heated to about 1800K. The pure metal is thus deposited on the filament.



(f) Chromatographic methods

This method is based on the principle that different components of a mixture are differently adsorbed on an adsorbent. The mixture is put in a liquid or gaseous medium which is moved through the adsorbent.

Different components are adsorbed at different levels on the column. Later the adsorbed components are removed (eluted) by using suitable solvents (eluant). Depending upon the physical state of the moving medium and the adsorbent material and also on the process of passage of the moving medium, the chromatographic method* is given the name. In one such method the column of Al_2O_3 is prepared in a glass tube and the moving medium containing a solution of the components is in liquid form. This is an example of *column chromatography*. This is very useful for purification of the elements which are available in minute quantities and the impurities are not very different in chemical properties from the element to be purified. There are several chromatographic techniques such as paper chromatography, column chromatography, gas chromatography, etc. Procedures followed in column chromatography have been depicted in Fig. 6.8.

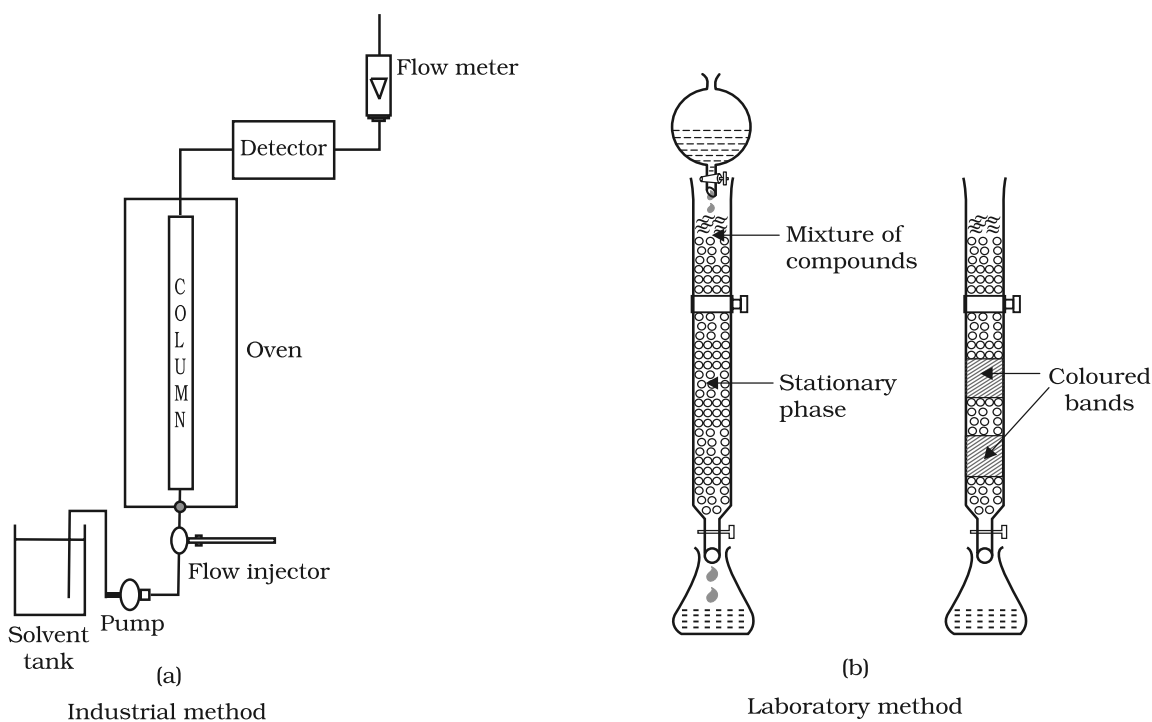

Fig. 6.8: Schematic diagrams showing column chromatography

* Looking it the other way, chromatography in general, involves a mobile phase and a stationary phase. The sample or sample extract is dissolved in a mobile phase. The mobile phase may be a gas, a liquid or a supercritical fluid. The stationary phase is immobile and immiscible (like the Al_2O_3 column in the example of column chromatography above). The mobile phase is then forced through the stationary phase. The mobile phase and the stationary phase are chosen such that components of the sample have different solubilities in the two phases. A component which is quite soluble in the stationary phase takes longer time to travel through it than a component which is not very soluble in the stationary phase but very soluble in the mobile phase. Thus sample components are separated from each other as they travel through the stationary phase. Depending upon the two phases and the way sample is inserted/injected, the chromatographic technique is named. These methods have been described in detail in Unit 12 of Class XI text book (12.8.5).

6.8 Uses of Aluminium, Copper, Zinc and Iron

Aluminium foils are used as wrappers for chocolates. The fine dust of the metal is used in paints and lacquers. Aluminium, being highly reactive, is also used in the extraction of chromium and manganese from their oxides. Wires of aluminium are used as electricity conductors. Alloys containing aluminium, being light, are very useful.

Copper is used for making wires in electrical industry and for water and steam pipes. It is also used in several alloys that are rather tougher than the metal itself, e.g., brass (with zinc), bronze (with tin) and coinage alloy (with nickel).

Zinc is used for galvanising iron. It is also used in large quantities in batteries, as a constituent of many alloys, e.g., brass, (Cu 60%, Zn 40%) and german silver (Cu 25-30%, Zn 25-30%, Ni 40-50%). Zinc dust is used as a reducing agent in the manufacture of dye-stuffs, paints, etc.

Cast iron, which is the most important form of iron, is used for casting stoves, railway sleepers, gutter pipes, toys, etc. It is used in the manufacture of wrought iron and steel. Wrought iron is used in making anchors, wires, bolts, chains and agricultural implements. Steel finds a number of uses. Alloy steel is obtained when other metals are added to it. Nickel steel is used for making cables, automobiles and aeroplane parts, pendulum, measuring tapes, chrome steel for cutting tools and crushing machines, and stainless steel for cycles, automobiles, utensils, pens, etc.

Summary

Metals are required for a variety of purposes. For this, we need their extraction from the minerals in which they are present and from which their extraction is commercially feasible. These minerals are known as **ores**. Ores of the metal are associated with many impurities. Removal of these impurities to certain extent is achieved in **concentration** steps. The concentrated ore is then treated chemically for obtaining the metal. Usually the metal compounds (e.g., oxides, sulphides) are reduced to the metal. The reducing agents used are carbon, CO or even some metals. In these reduction processes, the **thermodynamic** and **electrochemical** concepts are given due consideration. The metal oxide reacts with a reducing agent; the oxide is reduced to the metal and the reducing agent is oxidised. In the two reactions, the net Gibbs energy change is negative, which becomes more negative on raising the temperature. Conversion of the physical states from solid to liquid or to gas, and formation of gaseous states favours decrease in the Gibbs energy for the entire system. This concept is graphically displayed in plots of ΔG^\ominus vs T (Ellingham diagram) for such oxidation/reduction reactions at different temperatures. The concept of electrode potential is useful in the isolation of metals (e.g., Al, Ag, Au) where the sum of the two redox couples is +ve so that the Gibbs energy change is negative. The metals obtained by usual methods still contain minor impurities. Getting pure metals require **refining**. Refining process depends upon the differences in properties of the metal and the impurities. Extraction of aluminium is usually carried out from its bauxite ore by leaching it with NaOH. Sodium aluminate, thus formed, is separated and then neutralised to give back the hydrated oxide, which is then electrolysed using cryolite as a flux. Extraction of iron is done by reduction of its oxide ore in blast furnace. Copper is extracted by smelting and heating in a reverberatory furnace. Extraction of zinc from zinc oxides is done using coke. Several methods are employed

in refining the metal. Metals, in general, are very widely used and have contributed significantly in the development of a variety of industries.

Aluminium	1. Bauxite, $\text{Al}_2\text{O}_3 \cdot x\text{H}_2\text{O}$ 2. Cryolite, Na_3AlF_6	Electrolysis of Al_2O_3 dissolved in molten Na_3AlF_6	For the extraction, a good source of electricity is required.
Iron	1. Haematite, Fe_2O_3 2. Magnetite, Fe_3O_4	Reduction of the oxide with CO and coke in Blast furnace	Temperature approaching 2170 K is required.
Copper	1. Copper pyrites, CuFeS_2 2. Copper glance, Cu_2S 3. Malachite, $\text{CuCO}_3 \cdot \text{Cu}(\text{OH})_2$ 4. Cuprite, Cu_2O	Roasting of sulphide partially and reduction	It is self reduction in a specially designed converter. The reduction takes place easily. Sulphuric acid leaching is also used in hydrometallurgy from low grade ores.
Zinc	1. Zinc blende or Sphalerite, ZnS 2. Calamine, ZnCO_3 3. Zincite, ZnO	Roasting followed by reduction with coke	The metal may be purified by fractional distillation.

Exercises

- 6.1 Copper can be extracted by hydrometallurgy but not zinc. Explain.
- 6.2 What is the role of depressant in froth floatation process?
- 6.3 Why is the extraction of copper from pyrites more difficult than that from its oxide ore through reduction?
- 6.4 Explain: (i) Zone refining (ii) Column chromatography.
- 6.5 Out of C and CO, which is a better reducing agent at 673 K ?
- 6.6 Name the common elements present in the anode mud in electrolytic refining of copper. Why are they so present ?
- 6.7 Write down the reactions taking place in different zones in the blast furnace during the extraction of iron.
- 6.8 Write chemical reactions taking place in the extraction of zinc from zinc blende.
- 6.9 State the role of silica in the metallurgy of copper.
- 6.10 What is meant by the term "chromatography"?
- 6.11 What criterion is followed for the selection of the stationary phase in chromatography?

- 6.12 Describe a method for refining nickel.
- 6.13 How can you separate alumina from silica in a bauxite ore associated with silica? Give equations, if any.
- 6.14 Giving examples, differentiate between 'roasting' and 'calcination'.
- 6.15 How is 'cast iron' different from 'pig iron'?
- 6.16 Differentiate between "minerals" and "ores".
- 6.17 Why copper *matte* is put in silica lined converter?
- 6.18 What is the role of cryolite in the metallurgy of aluminium?
- 6.19 How is leaching carried out in case of low grade copper ores?
- 6.20 Why is zinc not extracted from zinc oxide through reduction using CO?
- 6.21 The value of $\Delta_f G^\ominus$ for formation of Cr_2O_3 is -540 kJmol^{-1} and that of Al_2O_3 is -827 kJmol^{-1} . Is the reduction of Cr_2O_3 possible with Al ?
- 6.22 Out of C and CO, which is a better reducing agent for ZnO ?
- 6.23 The choice of a reducing agent in a particular case depends on thermodynamic factor. How far do you agree with this statement? Support your opinion with two examples.
- 6.24 Name the processes from which chlorine is obtained as a by-product. What will happen if an aqueous solution of NaCl is subjected to electrolysis?
- 6.25 What is the role of graphite rod in the electrometallurgy of aluminium?
- 6.27 Outline the principles of refining of metals by the following methods:
 (i) Zone refining
 (ii) Electrolytic refining
 (iii) Vapour phase refining
- 6.28 Predict conditions under which Al might be expected to reduce MgO.
 (Hint: See Intext question 6.4)

Answers to Some Intext Questions

- 6.1 Ores in which one of the components (either the impurity or the actual ore) is magnetic can be concentrated, e.g., ores containing iron (haematite, magnetite, siderite and iron pyrites).
- 6.2 Leaching is significant as it helps in removing the impurities like SiO_2 , Fe_2O_3 , etc. from the bauxite ore.
- 6.3 Certain amount of activation energy is essential even for such reactions which are thermodynamically feasible, therefore heating is required.
- 6.4 Yes, below 1350°C Mg can reduce Al_2O_3 and above 1350°C , Al can reduce MgO. This can be inferred from ΔG^\ominus Vs T plots (Fig. 6.4).

Unit

7

The *p*-Block Elements

Objectives

After studying this Unit, you will be able to

- appreciate general trends in the chemistry of elements of groups 15, 16, 17 and 18;
- learn the preparation, properties and uses of dinitrogen and phosphorus and some of their important compounds;
- describe the preparation, properties and uses of dioxygen and ozone and chemistry of some simple oxides;
- know allotropic forms of sulphur, chemistry of its important compounds and the structures of its oxoacids;
- describe the preparation, properties and uses of chlorine and hydrochloric acid;
- know the chemistry of interhalogens and structures of oxoacids of halogens;
- enumerate the uses of noble gases;
- appreciate the importance of these elements and their compounds in our day to day life.

*Diversity in chemistry is the hallmark of *p*-block elements manifested in their ability to react with the elements of *s*-, *d*- and *f*-blocks as well as with their own.*

In Class XI, you have learnt that the *p*-block elements are placed in groups 13 to 18 of the periodic table. Their valence shell electronic configuration is ns^2np^{1-6} (except He which has $1s^2$ configuration). The properties of *p*-block elements like that of others are greatly influenced by atomic sizes, ionisation enthalpy, electron gain enthalpy and electronegativity. The absence of *d*-orbitals in second period and presence of *d* and/or *f* orbitals in heavier elements (starting from third period onwards) have significant effects on the properties of elements. In addition, the presence of all the three types of elements; metals, metalloids and non-metals bring diversification in chemistry of these elements.

Having learnt the chemistry of elements of Groups 13 and 14 of the *p*-block of periodic table in Class XI, you will learn the chemistry of the elements of subsequent groups in this Unit.

7.1 Group 15 Elements

Group 15 includes nitrogen, phosphorus, arsenic, antimony and bismuth. As we go down the group, there is a shift from non-metallic to metallic through metalloidal character. Nitrogen and phosphorus are non-metals, arsenic and antimony metalloids and bismuth is a typical metal.

7.1.1 Occurrence

Molecular nitrogen comprises 78% by volume of the atmosphere. In the earth's crust, it occurs as sodium nitrate, NaNO_3 (called Chile saltpetre) and potassium nitrate (Indian saltpetre). It is found in the form of proteins in plants and animals. Phosphorus occurs in minerals

of the apatite family, $\text{Ca}_9(\text{PO}_4)_6 \cdot \text{CaX}_2$ ($\text{X} = \text{F}, \text{Cl}$ or OH) (e.g., fluorapatite $\text{Ca}_9(\text{PO}_4)_6 \cdot \text{CaF}_2$) which are the main components of phosphate rocks. Phosphorus is an essential constituent of animal and plant matter. It is present in bones as well as in living cells. Phosphoproteins are present in milk and eggs. Arsenic, antimony and bismuth are found mainly as sulphide minerals.

The important atomic and physical properties of this group elements along with their electronic configurations are given in Table 7.1.

Table 7.1: Atomic and Physical Properties of Group 15 Elements

Property	N	P	As	Sb	Bi	
Atomic number	7	15	33	51	83	
Atomic mass/g mol^{-1}	14.01	30.97	74.92	121.75	208.98	
Electronic configuration	$[\text{He}]2s^22p^3$	$[\text{Ne}]3s^23p^3$	$[\text{Ar}]3d^{10}4s^24p^3$	$[\text{Kr}]4d^{10}5s^25p^3$	$[\text{Xe}]4f^{14}5d^{10}6s^26p^3$	
Ionisation enthalpy ($\Delta_i H/(\text{kJ mol}^{-1})$)	I	1402	1012	947	834	703
	II	2856	1903	1798	1595	1610
	III	4577	2910	2736	2443	2466
Electronegativity	3.0	2.1	2.0	1.9	1.9	
Covalent radius/pm ^a	70	110	121	141	148	
Ionic radius/pm	171 ^b	212 ^b	222 ^b	76 ^c	103 ^c	
Melting point/K	63*	317 ^d	1089 ^e	904	544	
Boiling point/K	77.2*	554 ^d	888 ^f	1860	1837	
Density/[g cm^{-3} (298 K)]	0.879 ^g	1.823	5.778 ^h	6.697	9.808	

^a E^{III} single bond ($E = \text{element}$); ^b E^{3-} ; ^c E^{3+} ; ^d White phosphorus; ^e Grey α -form at 38.6 atm; ^f Sublimation temperature; ^g At 63 K; ^h Grey α -form; * Molecular N_2 .

Trends of some of the atomic, physical and chemical properties of the group are discussed below.

7.1.2 Electronic Configuration

The valence shell electronic configuration of these elements is ns^2np^3 . The s orbital in these elements is completely filled and p orbitals are half-filled, making their electronic configuration extra stable.

7.1.3 Atomic and Ionic Radii

Covalent and ionic (in a particular state) radii increase in size down the group. There is a considerable increase in covalent radius from N to P. However, from As to Bi only a small increase in covalent radius is observed. This is due to the presence of completely filled d and/or f orbitals in heavier members.

7.1.4 Ionisation Enthalpy

Ionisation enthalpy decreases down the group due to gradual increase in atomic size. Because of the extra stable half-filled p orbitals electronic configuration and smaller size, the ionisation enthalpy of the group 15 elements is much greater than that of group 14 elements in the corresponding periods. The order of successive ionisation enthalpies, as expected is $\Delta_i H_1 < \Delta_i H_2 < \Delta_i H_3$ (Table 7.1).

7.1.5 Electronegativity

The electronegativity value, in general, decreases down the group with increasing atomic size. However, amongst the heavier elements, the difference is not that much pronounced.

7.1.6 Physical Properties

All the elements of this group are polyatomic. Dinitrogen is a diatomic gas while all others are solids. Metallic character increases down the group. Nitrogen and phosphorus are non-metals, arsenic and antimony metalloids and bismuth is a metal. This is due to decrease in ionisation enthalpy and increase in atomic size. The boiling points, in general, increase from top to bottom in the group but the melting point increases upto arsenic and then decreases upto bismuth. Except nitrogen, all the elements show allotropy.

7.1.7 Chemical Properties

Oxidation states and trends in chemical reactivity

The common oxidation states of these elements are -3, +3 and +5. The tendency to exhibit -3 oxidation state decreases down the group due to increase in size and metallic character. In fact last member of the group, bismuth hardly forms any compound in -3 oxidation state. The stability of +5 oxidation state decreases down the group. The only well characterised Bi (V) compound is BiF_5 . The stability of +5 oxidation state decreases and that of +3 state increases (due to inert pair effect) down the group. Nitrogen exhibits +1, +2, +4 oxidation states also when it reacts with oxygen. Phosphorus also shows +1 and +4 oxidation states in some oxoacids.

In the case of nitrogen, all oxidation states from +1 to +4 tend to disproportionate in acid solution. For example,

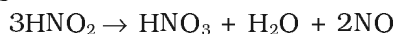

Similarly, in case of phosphorus nearly all intermediate oxidation states disproportionate into +5 and -3 both in alkali and acid. However +3 oxidation state in case of arsenic, antimony and bismuth become increasingly stable with respect to disproportionation.

Nitrogen is restricted to a maximum covalency of 4 since only four (one *s* and three *p*) orbitals are available for bonding. The heavier elements have vacant *d* orbitals in the outermost shell which can be used for bonding (covalency) and hence, expand their covalence as in PF_6^- .

Anomalous properties of nitrogen

Nitrogen differs from the rest of the members of this group due to its smaller size, high electronegativity, high ionisation enthalpy and non-availability of *d* orbitals. Nitrogen has unique ability to form ***pπ-pπ* multiple** bonds with itself and with other elements having small size and high electronegativity (e.g., C, O). Heavier elements of this group do not form *pπ-pπ* bonds as their atomic orbitals are so large and diffuse that they cannot have effective overlapping. Thus, nitrogen exists as a diatomic molecule with a triple bond (one *s* and two *p*) between the two atoms. Consequently, its bond enthalpy ($941.4 \text{ kJ mol}^{-1}$) is very high. On the contrary, phosphorus, arsenic and antimony form single bonds as P-P, As-As and Sb-Sb while bismuth forms metallic bonds in elemental state. However, the single N-N bond is weaker than the single P-P bond because of high interelectronic repulsion of the non-bonding electrons, owing to the small bond length. As a result the catenation tendency is weaker in

nitrogen. Another factor which affects the chemistry of nitrogen is the absence of d orbitals in its valence shell. Besides restricting its covalency to four, nitrogen cannot form $d\pi-p\pi$ bond as the heavier elements can e.g., $R_3P=O$ or $R_3P=CH_2$ (R = alkyl group). Phosphorus and arsenic can form $d\pi-d\pi$ bond also with transition metals when their compounds like $P(C_2H_5)_3$ and $As(C_6H_5)_3$ act as ligands.

- (i) *Reactivity towards hydrogen:* All the elements of Group 15 form hydrides of the type EH_3 where $E = N, P, As, Sb$ or Bi . Some of the properties of these hydrides are shown in Table 7.2. The hydrides show regular gradation in their properties. The stability of hydrides decreases from NH_3 to BiH_3 which can be observed from their bond dissociation enthalpy. Consequently, the reducing character of the hydrides increases. Ammonia is only a mild reducing agent while BiH_3 is the strongest reducing agent amongst all the hydrides. Basicity also decreases in the order $NH_3 > PH_3 > AsH_3 > SbH_3 \geq BiH_3$.

Table 7.2: Properties of Hydrides of Group 15 Elements

Property	NH_3	PH_3	AsH_3	SbH_3	BiH_3
Melting point/K	195.2	139.5	156.7	185	–
Boiling point/K	238.5	185.5	210.6	254.6	290
(E–H) Distance/pm	101.7	141.9	151.9	170.7	–
HEH angle ($^\circ$)	107.8	93.6	91.8	91.3	–
$\Delta_f H^\ominus / \text{kJ mol}^{-1}$	–46.1	13.4	66.4	145.1	278
$\Delta_{diss} H^\ominus (\text{E–H}) / \text{kJ mol}^{-1}$	389	322	297	255	–

- (ii) *Reactivity towards oxygen:* All these elements form two types of oxides: E_2O_3 and E_2O_5 . The oxide in the higher oxidation state of the element is more acidic than that of lower oxidation state. Their acidic character decreases down the group. The oxides of the type E_2O_3 of nitrogen and phosphorus are purely acidic, that of arsenic and antimony amphoteric and those of bismuth is predominantly basic.
- (iii) *Reactivity towards halogens:* These elements react to form two series of halides: EX_3 and EX_5 . Nitrogen does not form pentahalide due to non-availability of the d orbitals in its valence shell. Pentahalides are more covalent than trihalides. All the trihalides of these elements except those of nitrogen are stable. In case of nitrogen, only NF_3 is known to be stable. Trihalides except BiF_3 are predominantly covalent in nature.
- (iv) *Reactivity towards metals:* All these elements react with metals to form their binary compounds exhibiting -3 oxidation state, such as, Ca_3N_2 (calcium nitride) Ca_3P_2 (calcium phosphide), Na_3As_2 (sodium arsenide), Zn_3Sb_2 (zinc antimonide) and Mg_3Bi_2 (magnesium bismuthide).

Though nitrogen exhibits +5 oxidation state, it does not form pentahalide. Give reason.

Example 7.1

Nitrogen with $n = 2$, has s and p orbitals only. It does not have d orbitals to expand its covalence beyond four. That is why it does not form pentahalide.

Solution

PH_3 has lower boiling point than NH_3 . Why?

Example 7.2

Unlike NH_3 , PH_3 molecules are not associated through hydrogen bonding in liquid state. That is why the boiling point of PH_3 is lower than NH_3 .

Solution

Intext Questions

7.1 Why are pentahalides more covalent than trihalides ?

7.2 Why is BiH_3 the strongest reducing agent amongst all the hydrides of Group 15 elements ?

7.2 Dinitrogen

Preparation

Dinitrogen is produced commercially by the liquefaction and fractional distillation of air. Liquid dinitrogen (b.p. 77.2 K) distils out first leaving behind liquid oxygen (b.p. 90 K).

In the laboratory, dinitrogen is prepared by treating an aqueous solution of ammonium chloride with sodium nitrite.

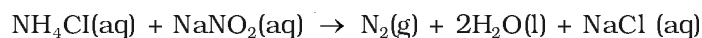

Small amounts of NO and HNO_3 are also formed in this reaction; these impurities can be removed by passing the gas through aqueous sulphuric acid containing potassium dichromate. It can also be obtained by the thermal decomposition of ammonium dichromate.

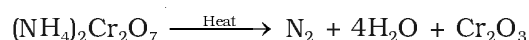

Very pure nitrogen can be obtained by the thermal decomposition of sodium or barium azide.

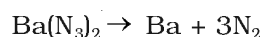

Properties

Dinitrogen is a colourless, odourless, tasteless and non-toxic gas. It has two stable isotopes: ^{14}N and ^{15}N . It has a very low solubility in water (23.2 cm^3 per litre of water at 273 K and 1 bar pressure) and low freezing and boiling points (Table 7.1).

Dinitrogen is rather inert at room temperature because of the high bond enthalpy of $\text{N}\equiv\text{N}$ bond. Reactivity, however, increases rapidly with rise in temperature. At higher temperatures, it directly combines with some metals to form predominantly ionic nitrides and with non-metals, covalent nitrides. A few typical reactions are:

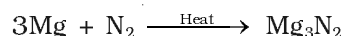
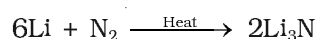

It combines with hydrogen at about 773 K in the presence of a catalyst (Haber's Process) to form ammonia:

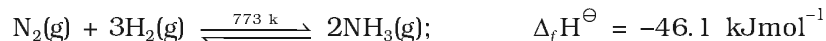

Dinitrogen combines with dioxygen only at very high temperature (at about 2000 K) to form nitric oxide, NO.

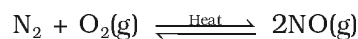

Uses: The main use of dinitrogen is in the manufacture of ammonia and other industrial chemicals containing nitrogen, (e.g., calcium cyanamide). It also finds use where an inert atmosphere is required (e.g., in iron and steel industry, inert diluent for reactive chemicals). Liquid dinitrogen is used as a refrigerant to preserve biological materials, food items and in cryosurgery.

Example 7.3 Write the reaction of thermal decomposition of sodium azide.

Solution Thermal decomposition of sodium azide gives dinitrogen gas.

$$2\text{NaN}_3 \rightarrow 2\text{Na} + 3\text{N}_2$$

Intext Question

7.3 Why is N_2 less reactive at room temperature?

7.3 Ammonia

Preparation

Ammonia is present in small quantities in air and soil where it is formed by the decay of nitrogenous organic matter e.g., urea.

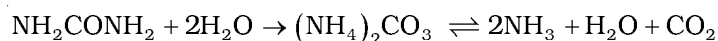

On a small scale ammonia is obtained from ammonium salts which decompose when treated with caustic soda or lime.

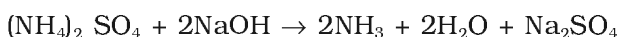
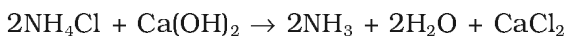

On a large scale, ammonia is manufactured by Haber's process.



In accordance with Le Chatelier's principle, high pressure would favour the formation of ammonia. The optimum conditions for the production of ammonia are a pressure of 200×10^5 Pa (about 200 atm), a temperature of ~ 700 K and the use of a catalyst such as iron oxide with small amounts of K_2O and Al_2O_3 to increase the rate of attainment of equilibrium. The flow chart for the production of ammonia is shown in Fig. 7.1.

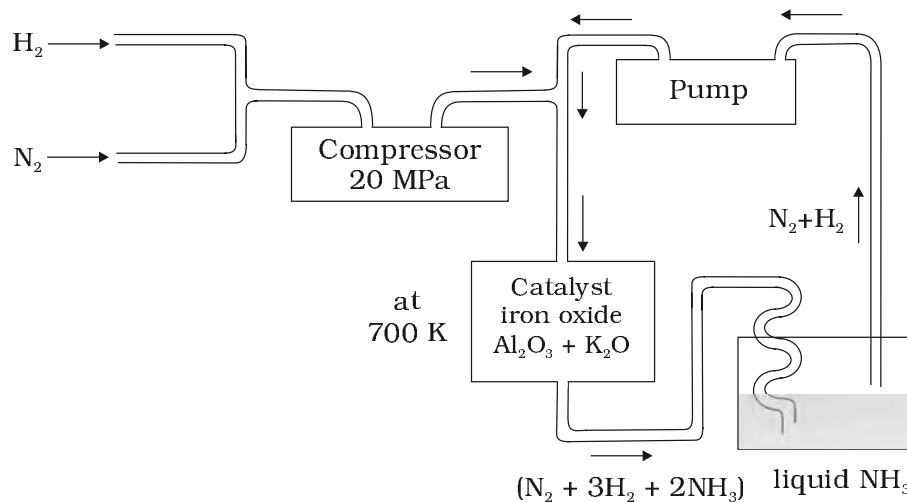
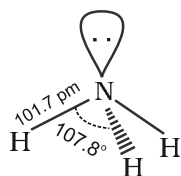

Fig. 7.1
Flow chart for the
manufacture of
ammonia



Properties

Ammonia is a colourless gas with a pungent odour. Its freezing and boiling points are 198.4 and 239.7 K respectively. In the solid and liquid states, it is associated through hydrogen bonds as in the case of water and that accounts for its higher melting and boiling points than expected on the basis of its molecular mass. The ammonia molecule is trigonal pyramidal with the nitrogen atom at the apex. It has three bond pairs and one lone pair of electrons as shown in the structure.

Ammonia gas is highly soluble in water. Its aqueous solution is weakly basic due to the formation of OH^- ions.



It forms ammonium salts with acids, e.g., NH_4Cl , $(\text{NH}_4)_2\text{SO}_4$, etc. As a weak base, it precipitates the hydroxides of many metals from their salt solutions. For example,

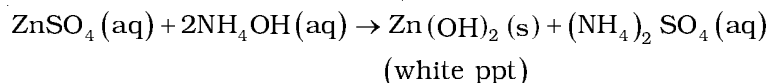
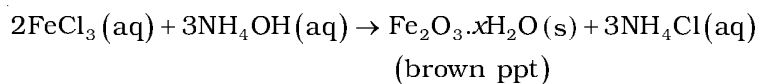

The presence of a lone pair of electrons on the nitrogen atom of the ammonia molecule makes it a Lewis base. It donates the electron pair and forms linkage with metal ions and the formation of such complex compounds finds applications in detection of metal ions such as Cu^{2+} , Ag^+ :

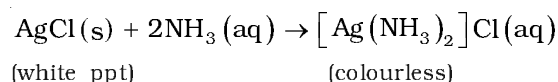
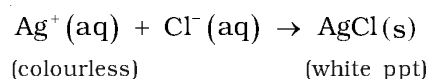
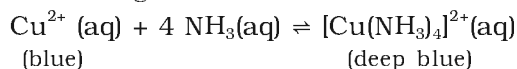

Uses: Ammonia is used to produce various nitrogenous fertilisers (ammonium nitrate, urea, ammonium phosphate and ammonium sulphate) and in the manufacture of some inorganic nitrogen compounds, the most important one being nitric acid. Liquid ammonia is also used as a refrigerant.

Example 7.4 Why does NH_3 act as a Lewis base ?

Solution Nitrogen atom in NH_3 has one lone pair of electrons which is available for donation. Therefore, it acts as a Lewis base.

Intext Questions

7.4 Mention the conditions required to maximise the yield of ammonia.

7.5 How does ammonia react with a solution of Cu^{2+} ?

7.4 Oxides of Nitrogen

Nitrogen forms a number of oxides in different oxidation states. The names, formulas, preparation and physical appearance of these oxides are given in Table 7.3.

Table 7.3: Oxides of Nitrogen

Name	Formula	Oxidation state of nitrogen	Common methods of preparation	Physical appearance and chemical nature
Dinitrogen oxide [Nitrogen(I) oxide]	N_2O	+ 1	$\text{NH}_4\text{NO}_3 \xrightarrow{\text{Heat}} \text{N}_2\text{O} + 2\text{H}_2\text{O}$	colourless gas, neutral
Nitrogen monoxide [Nitrogen(II) oxide]	NO	+ 2	$2\text{NaNO}_2 + 2\text{FeSO}_4 + 3\text{H}_2\text{SO}_4 \rightarrow \text{Fe}_2(\text{SO}_4)_3 + 2\text{NaHSO}_4 + 2\text{H}_2\text{O} + 2\text{NO}$	colourless gas, neutral
Dinitrogen trioxide [Nitrogen(III) oxide]	N_2O_3	+ 3	$2\text{NO} + \text{N}_2\text{O}_4 \xrightarrow{250\text{K}} 2\text{N}_2\text{O}_3$	blue solid, acidic
Nitrogen dioxide [Nitrogen(IV) oxide]	NO_2	+ 4	$2\text{Pb}(\text{NO}_3)_2 \xrightarrow{673\text{K}} 4\text{NO}_2 + 2\text{PbO}$	brown gas, acidic
Dinitrogen tetroxide [Nitrogen(IV) oxide]	N_2O_4	+ 4	$2\text{NO}_2 \xrightleftharpoons[\text{Heat}]{\text{Cool}} \text{N}_2\text{O}_4$	colourless solid/liquid, acidic
Dinitrogen pentoxide [Nitrogen(V) oxide]	N_2O_5	+5	$4\text{HNO}_3 + \text{P}_4\text{O}_{10} \rightarrow 4\text{HPO}_3 + 2\text{N}_2\text{O}_5$	colourless solid, acidic

Lewis dot main resonance structures and bond parameters of oxides are given in Table 7.4.

Table 7.4: Structures of Oxides of Nitrogen

Formula	Resonance Structures	Bond Parameters
N_2O	$\ddot{N}=N=\ddot{O} \leftrightarrow :N\equiv N-\ddot{O}:$	$N - N - O$ 113 pm 119 pm Linear
NO	$:\dot{N} = \ddot{O} : \leftrightarrow :\ddot{N} = \ddot{O} :$	$N - O$ 115 pm
N_2O_3		 Planar
NO_2		 Angular
N_2O_4		 Planar
N_2O_5		 Planar

Why does NO_2 dimerise ?

NO_2 contains odd number of valence electrons. It behaves as a typical odd molecule. On dimerisation, it is converted to stable N_2O_4 molecule with even number of electrons.

Example 7.5

Solution

Intext Question

7.6 What is the covalence of nitrogen in N_2O_5 ?

7.5 Nitric Acid

Nitrogen forms oxoacids such as $H_2N_2O_2$ (hyponitrous acid), HNO_2 (nitrous acid) and HNO_3 (nitric acid). Amongst them HNO_3 is the most important.

Preparation

In the laboratory, nitric acid is prepared by heating KNO_3 or NaNO_3 and concentrated H_2SO_4 in a glass retort.

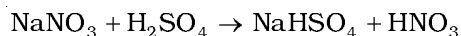

On a large scale it is prepared mainly by Ostwald's process.

This method is based upon catalytic oxidation of NH_3 by atmospheric oxygen.

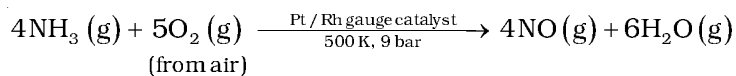

Nitric oxide thus formed combines with oxygen giving NO_2 .

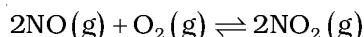

Nitrogen dioxide so formed, dissolves in water to give HNO_3 .

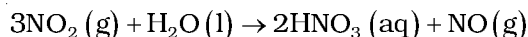

NO thus formed is recycled and the aqueous HNO_3 can be concentrated by distillation upto ~ 68% by mass. Further concentration to 98% can be achieved by dehydration with concentrated H_2SO_4 .

Properties

It is a colourless liquid (f.p. 231.4 K and b.p. 355.6 K). Laboratory grade nitric acid contains ~ 68% of the HNO_3 by mass and has a specific gravity of 1.504.

In the gaseous state, HNO_3 exists as a planar molecule with the structure as shown.

In aqueous solution, nitric acid behaves as a strong acid giving hydronium and nitrate ions.

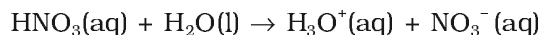

Concentrated nitric acid is a strong oxidising agent and attacks most metals except noble metals such as gold and platinum. The products of oxidation depend upon the concentration of the acid, temperature and the nature of the material undergoing oxidation.

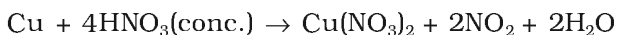
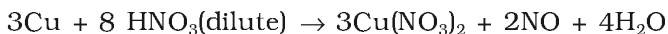

Zinc reacts with dilute nitric acid to give N_2O and with concentrated acid to give NO_2 .

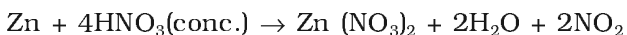
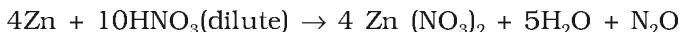

Some metals (e.g., Cr, Al) do not dissolve in concentrated nitric acid because of the formation of a passive film of oxide on the surface.

Concentrated nitric acid also oxidises non-metals and their compounds. Iodine is oxidised to iodic acid, carbon to carbon dioxide, sulphur to H_2SO_4 , and phosphorus to phosphoric acid.

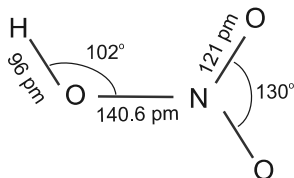

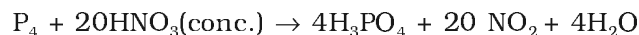
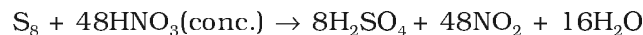

Brown Ring Test: The familiar brown ring test for nitrates depends on the ability of Fe^{2+} to reduce nitrates to nitric oxide, which reacts with Fe^{2+} to form a brown coloured complex. The test is usually carried out by adding dilute ferrous sulphate solution to an aqueous solution containing nitrate ion, and then carefully adding concentrated sulphuric acid along the sides of the test tube. A brown ring at the interface between the solution and sulphuric acid layers indicate the presence of nitrate ion in solution.

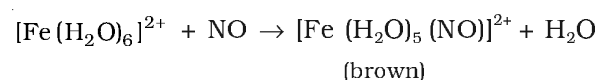
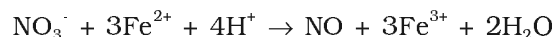

Uses: The major use of nitric acid is in the manufacture of ammonium nitrate for fertilisers and other nitrates for use in explosives and pyrotechnics. It is also used for the preparation of nitroglycerin, trinitrotoluene and other organic nitro compounds. Other major uses are in the *pickling of stainless steel*, etching of metals and as an oxidiser in rocket fuels.

7.6 Phosphorus — Allotropic Forms

Phosphorus is found in many allotropic forms, the important ones being white, red and black.

White phosphorus is a translucent white waxy solid. It is poisonous, insoluble in water but soluble in carbon disulphide and glows in dark (chemiluminescence). It dissolves in boiling NaOH solution in an inert atmosphere giving PH_3 .

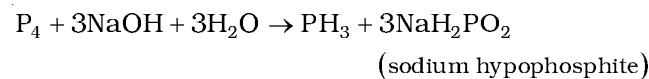

White phosphorus is less stable and therefore, more reactive than the other solid phases under normal conditions because of angular strain in the P_4 molecule where the angles are only 60° . It readily catches fire in air to give dense white fumes of P_4O_{10} .

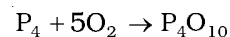

It consists of discrete tetrahedral P_4 molecule as shown in Fig. 7.2.

Red phosphorus is obtained by heating white phosphorus at 573K in an inert atmosphere for several days. When red phosphorus is heated under high pressure, a series of phases of black phosphorus are formed. Red phosphorus possesses iron grey lustre. It is odourless, non-poisonous and insoluble in water as well as in carbon disulphide. Chemically, red phosphorus is much less reactive than white phosphorus. It does not glow in the dark.

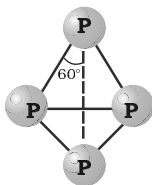

Fig. 7.2
White phosphorus

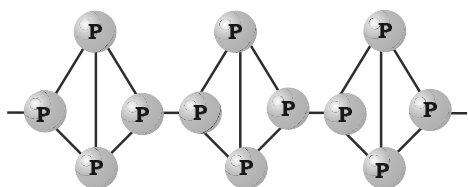

Fig.7.3: Red phosphorus

It is polymeric, consisting of chains of P_4 tetrahedra linked together in the manner as shown in Fig. 7.3.

Black phosphorus has two forms α -black phosphorus and β -black phosphorus. α -Black phosphorus is formed when red phosphorus is heated in a sealed tube at 803K. It can be sublimed in air and has opaque monoclinic or rhombohedral crystals. It does not oxidise in air. β -Black phosphorus is prepared by heating white phosphorus at 473 K under high pressure. It does not burn in air upto 673 K.

7.7 Phosphine

Preparation

Phosphine is prepared by the reaction of calcium phosphide with water or dilute HCl.

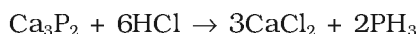
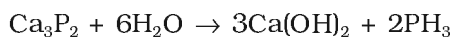

In the laboratory, it is prepared by heating white phosphorus with concentrated NaOH solution in an inert atmosphere of CO_2 .

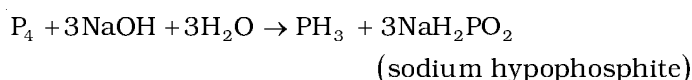

When pure, it is non inflammable but becomes inflammable owing to the presence of P_2H_4 or P_4 vapours. To purify it from the impurities, it is absorbed in HI to form phosphonium iodide (PH_4I) which on treating with KOH gives off phosphine.

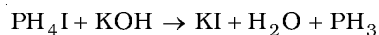

Properties

It is a colourless gas with rotten fish smell and is highly poisonous. It explodes in contact with traces of oxidising agents like HNO_3 , Cl_2 and Br_2 vapours.

It is slightly soluble in water. The solution of PH_3 in water decomposes in presence of light giving red phosphorus and H_2 . When absorbed in copper sulphate or mercuric chloride solution, the corresponding phosphides are obtained.

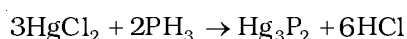
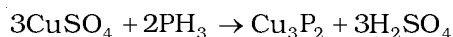

Phosphine is weakly basic and like ammonia, gives phosphonium compounds with acids e.g.,

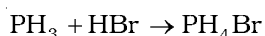

Uses: The spontaneous combustion of phosphine is technically used in *Holme's signals*. Containers containing calcium carbide and calcium phosphide are pierced and thrown in the sea when the gases evolved burn and serve as a signal. It is also used in *smoke screens*.

In what way can it be proved that PH_3 is basic in nature? *Example 7.6*

PH_3 reacts with acids like HI to form PH_4I which shows that it is basic in nature. *Solution*

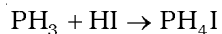

Due to lone pair on phosphorus atom, PH_3 is acting as a Lewis base in the above reaction.

Intext Questions

7.7 Bond angle in PH_4^+ is higher than that in PH_3 . Why?

7.8 What happens when white phosphorus is heated with concentrated NaOH solution in an inert atmosphere of CO_2 ?

7.8 Phosphorus Halides Phosphorus forms two types of halides, PX_3 ($\text{X} = \text{F}, \text{Cl}, \text{Br}, \text{I}$) and PX_5 ($\text{X} = \text{F}, \text{Cl}, \text{Br}$).

7.8.1 Phosphorus Trichloride

Preparation

It is obtained by passing dry chlorine over heated white phosphorus.

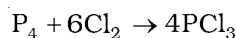

It is also obtained by the action of thionyl chloride with white phosphorus.



Properties

It is a colourless oily liquid and hydrolyses in the presence of moisture.

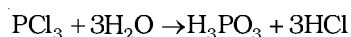

It reacts with organic compounds containing $-\text{OH}$ group such as CH_3COOH , $\text{C}_2\text{H}_5\text{OH}$.

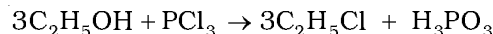
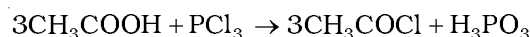

It has a pyramidal shape as shown, in which phosphorus is sp^3 hybridised.

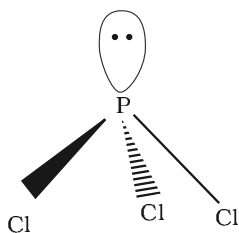

7.8.2 Phosphorus Pentachloride

Preparation

Phosphorus pentachloride is prepared by the reaction of white phosphorus with excess of dry chlorine.

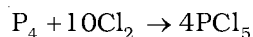

It can also be prepared by the action of SO_2Cl_2 on phosphorus.

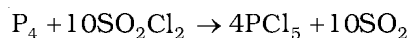

Properties

PCl_5 is a yellowish white powder and in moist air, it hydrolyses to POCl_3 and finally gets converted to phosphoric acid.

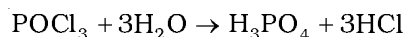
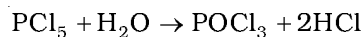

When heated, it sublimes but decomposes on stronger heating.

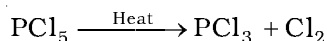

It reacts with organic compounds containing –OH group converting them to chloro derivatives.

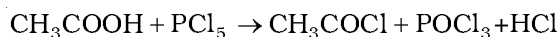
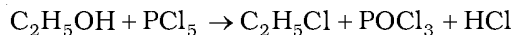

Finely divided metals on heating with PCl_5 give corresponding chlorides.

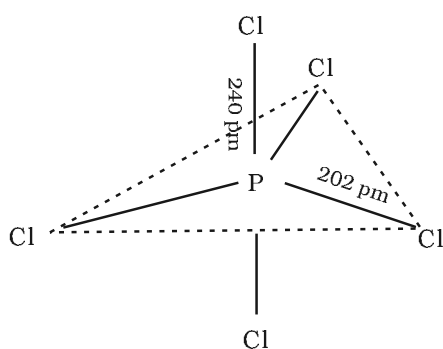
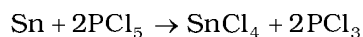
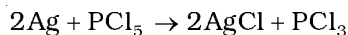

It is used in the synthesis of some organic compounds, e.g., $\text{C}_2\text{H}_5\text{Cl}$, CH_3COCl .

In gaseous and liquid phases, it has a trigonal bipyramidal structure as shown below. The three equatorial P–Cl bonds are equivalent, while the two axial bonds are longer than equatorial bonds. This is due to the fact that the axial bond pairs suffer more repulsion as compared to equatorial bond pairs.

In the solid state it exists as an ionic solid, $[\text{PCl}_4]^+[\text{PCl}_6]^-$ in which the cation, $[\text{PCl}_4]^+$ is tetrahedral and the anion, $[\text{PCl}_6]^-$ octahedral.

Example 7.7 Why does PCl_3 fume in moisture ?

Solution PCl_3 hydrolyses in the presence of moisture giving fumes of HCl.

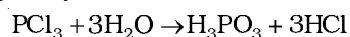

Example 7.8 Are all the five bonds in PCl_5 molecule equivalent? Justify your answer.

Solution PCl_5 has a trigonal bipyramidal structure and the three equatorial P–Cl bonds are equivalent, while the two axial bonds are different and longer than equatorial bonds.

Intext Questions

7.9 What happens when PCl_5 is heated?

7.10 Write a balanced equation for the hydrolytic reaction of PCl_5 in heavy water.

7.9 Oxoacids of Phosphorus

Phosphorus forms a number of oxoacids. The important oxoacids of phosphorus with their formulas, methods of preparation and the presence of some characteristic bonds in their structures are given in Table 7.5.

Table 7.5: Oxoacids of Phosphorus

Name	Formula	Oxidation state of phosphorus	Characteristic bonds and their number	Preparation
Hypophosphorous (Phosphinic)	H_3PO_2	+1	One P – OH Two P – H One P = O	white P_4 + alkali
Orthophosphorous (Phosphonic)	H_3PO_3	+3	Two P – OH One P – H One P = O	$P_2O_3 + H_2O$
Pyrophosphorous	$H_4P_2O_5$	+3	Two P – OH Two P – H Two P = O	$PCl_3 + H_3PO_3$
Hypophosphoric	$H_4P_2O_6$	+4	Four P – OH Two P = O One P – P	red P_4 + alkali
Orthophosphoric	H_3PO_4	+5	Three P – OH One P = O	$P_4O_{10} + H_2O$
Pyrophosphoric	$H_4P_2O_7$	+5	Four P – OH Two P = O One P – O – P	heat phosphoric acid
Metaphosphoric*	$(HPO_3)_n$	+5	Three P – OH Three P = O Three P – O – P	phosphorus acid + Br_2 , heat in a sealed tube

* Exists in polymeric forms only. Characteristic bonds of $(HPO_3)_3$ have been given in the Table.

The compositions of the oxoacids are interrelated in terms of loss or gain of H_2O molecule or O-atom.

The structures of some important oxoacids are given below:

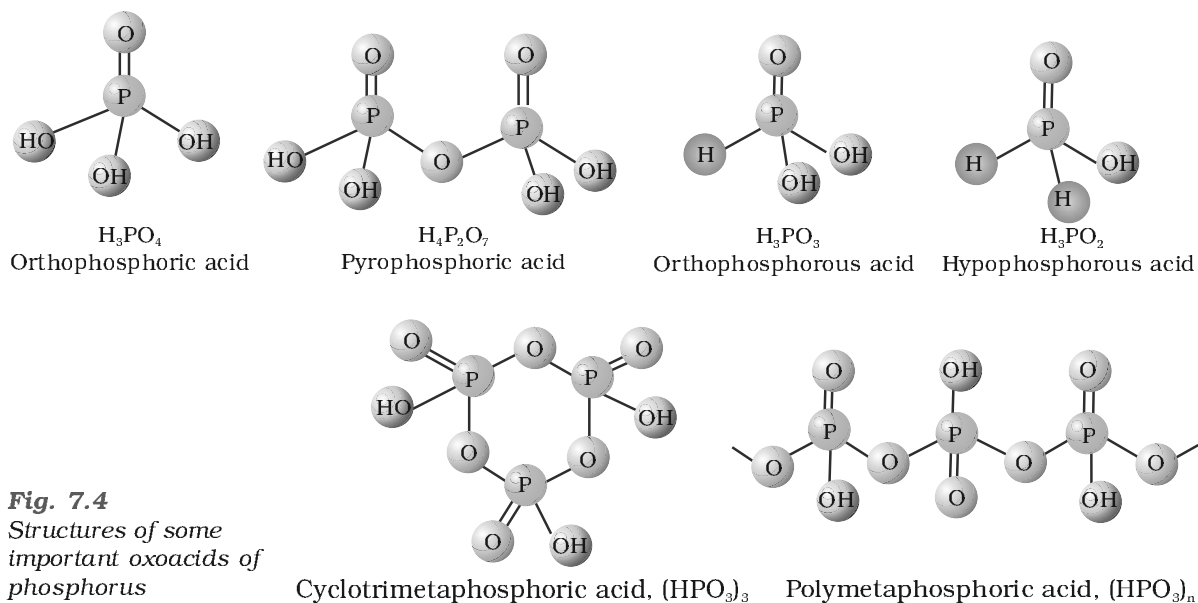
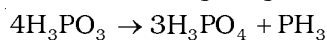
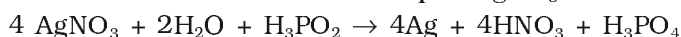

Fig. 7.4
Structures of some important oxoacids of phosphorus

In oxoacids phosphorus is tetrahedrally surrounded by other atoms. All these acids contain one P=O and at least one P-OH bond. The oxoacids in which phosphorus has lower oxidation state (less than +5) contain, in addition to P=O and P-OH bonds, either P-P (e.g., in $\text{H}_4\text{P}_2\text{O}_6$) or P-H (e.g., in H_3PO_2) bonds but not both. These acids in +3 oxidation state of phosphorus tend to disproportionate to higher and lower oxidation states. For example, orthophosphorous acid (or phosphorous acid) on heating disproportionates to give orthophosphoric acid (or phosphoric acid) and phosphine.



The acids which contain P-H bond have strong reducing properties. Thus, hypophosphorous acid is a good reducing agent as it contains two P-H bonds and reduces, for example, AgNO_3 to metallic silver.



These P-H bonds are not ionisable to give H^+ and do not play any role in basicity. Only those H atoms which are attached with oxygen in P-OH form are ionisable and cause the basicity. Thus, H_3PO_3 and H_3PO_4 are dibasic and tribasic, respectively as the structure of H_3PO_3 has two P-OH bonds and H_3PO_4 three.

Example 7.9 How do you account for the reducing behaviour of H_3PO_2 on the basis of its structure ?

Solution In H_3PO_2 , two H atoms are bonded directly to P atom which imparts reducing character to the acid.

Intext Questions

7.11 What is the basicity of H_3PO_4 ?

7.12 What happens when H_3PO_3 is heated?

7.10 Group 16 Elements

Oxygen, sulphur, selenium, tellurium and polonium constitute Group 16 of the periodic table. This is sometimes known as group of *chalcogens*. The name is derived from the Greek word for brass and points to the association of sulphur and its congeners with copper. Most copper minerals contain either oxygen or sulphur and frequently the other members of the group.

7.10.1 Occurrence

Oxygen is the most abundant of all the elements on earth. Oxygen forms about 46.6% by mass of earth's crust. Dry air contains 20.946% oxygen by volume.

However, the abundance of sulphur in the earth's crust is only 0.03-0.1%. Combined sulphur exists primarily as sulphates such as *gypsum* $\text{CaSO}_4 \cdot 2\text{H}_2\text{O}$, *epsom salt* $\text{MgSO}_4 \cdot 7\text{H}_2\text{O}$, *baryte* BaSO_4 and sulphides such as *galena* PbS , *zinc blende* ZnS , *copper pyrites* CuFeS_2 . Traces of sulphur occur as hydrogen sulphide in volcanoes. Organic materials such as eggs, proteins, garlic, onion, mustard, hair and wool contain sulphur.

Selenium and tellurium are also found as metal selenides and tellurides in sulphide ores. Polonium occurs in nature as a decay product of thorium and uranium minerals.

The important atomic and physical properties of Group 16 along with electronic configuration are given in Table 7.6. Some of the atomic, physical and chemical properties and their trends are discussed below.

- 7.10.2 Electronic Configuration** The elements of Group 16 have six electrons in the outermost shell and have ns^2np^4 general electronic configuration.
- 7.10.3 Atomic and Ionic Radii** Due to increase in the number of shells, atomic and ionic radii increase from top to bottom in the group. The size of oxygen atom is, however, exceptionally small.
- 7.10.4 Ionisation Enthalpy** Ionisation enthalpy decreases down the group. It is due to increase in size. However, the elements of this group have lower ionisation enthalpy values compared to those of Group 15 in the corresponding periods. This is due to the fact that Group 15 elements have extra stable half-filled p orbitals electronic configurations.
- 7.10.5 Electron Gain Enthalpy** Because of the compact nature of oxygen atom, it has less negative electron gain enthalpy than sulphur. However, from sulphur onwards the value again becomes less negative upto polonium.
- 7.10.6 Electronegativity** Next to fluorine, oxygen has the highest electronegativity value amongst the elements. Within the group, electronegativity decreases with an increase in atomic number. This implies that the metallic character increases from oxygen to polonium.

Elements of Group 16 generally show lower value of first ionisation enthalpy compared to the corresponding periods of group 15. Why?

Example 7.10

Due to extra stable half-filled p orbitals electronic configurations of Group 15 elements, larger amount of energy is required to remove electrons compared to Group 16 elements.

Solution

- 7.10.7 Physical Properties** Some of the physical properties of Group 16 elements are given in Table 7.6. Oxygen and sulphur are non-metals, selenium and tellurium metalloids, whereas polonium is a metal. Polonium is radioactive and is short lived (Half-life 13.8 days). All these elements exhibit allotropy. The melting and boiling points increase with an increase in atomic number down the group. The large difference between the melting and boiling points of oxygen and sulphur may be explained on the basis of their atomicity; oxygen exists as diatomic molecule (O_2) whereas sulphur exists as polyatomic molecule (S_8).
- 7.10.8 Chemical Properties** *Oxidation states and trends in chemical reactivity*
The elements of Group 16 exhibit a number of oxidation states (Table 7.6). The stability of -2 oxidation state decreases down the group. Polonium hardly shows -2 oxidation state. Since electronegativity of oxygen is very high, it shows only negative oxidation state as -2 except

Table 7.6: Some Physical Properties of Group 16 Elements

Property	O	S	Se	Te	Po
Atomic number	8	16	34	52	84
Atomic mass/g mol ⁻¹	16.00	32.06	78.96	127.60	210.00
Electronic configuration	[He]2s ² 2p ⁴	[Ne]3s ² 3p ⁴	[Ar]3d ¹⁰ 4s ² 4p ⁴	[Kr]4d ¹⁰ 5s ² 5p ⁴	[Xe]4f ¹⁴ 5d ¹⁰ 6s ² 6p ⁴
Covalent radius/(pm) ^a	66	104	117	137	146
Ionic radius, E ²⁻ /pm	140	184	198	221	230 ^b
Electron gain enthalpy, /Δ _{eg} H kJ mol ⁻¹	-141	-200	-195	-190	-174
Ionisation enthalpy (Δ _i H ₁) /kJ mol ⁻¹	1314	1000	941	869	813
Electronegativity	3.50	2.44	2.48	2.01	1.76
Density /g cm ⁻³ (298 K)	1.32 ^c	2.06 ^d	4.19 ^e	6.25	–
Melting point/K	55	393 ^f	490	725	520
Boiling point/K	90	718	958	1260	1235
Oxidation states*	-2,-1,1,2	-2,2,4,6	-2,2,4,6	-2,2,4,6	2,4

^aSingle bond; ^bApproximate value; ^cAt the melting point; ^dRhombic sulphur; ^eHexagonal grey; ^fMonoclinic form, 673 K.

* Oxygen shows oxidation states of +2 and +1 in oxygen fluorides OF₂ and O₂F₂ respectively.

in the case of OF₂ where its oxidation state is + 2. Other elements of the group exhibit + 2, + 4, + 6 oxidation states but + 4 and + 6 are more common. Sulphur, selenium and tellurium usually show + 4 oxidation state in their compounds with oxygen and + 6 with fluorine. The stability of + 6 oxidation state decreases down the group and stability of + 4 oxidation state increase (inert pair effect). Bonding in +4 and +6 oxidation states are primarily covalent.

Anomalous behaviour of oxygen

The anomalous behaviour of oxygen, like other members of *p*-block present in second period is due to its small size and high electronegativity. One typical example of effects of small size and high electronegativity is the presence of strong hydrogen bonding in H₂O which is not found in H₂S.

The absence of *d* orbitals in oxygen limits its covalency to four and in practice, rarely exceeds two. On the other hand, in case of other elements of the group, the valence shells can be expanded and covalence exceeds four.

- (i) *Reactivity with hydrogen:* All the elements of Group 16 form hydrides of the type H₂E (E = S, Se, Te, Po). Some properties of hydrides are given in Table 7.7. Their acidic character increases from H₂O to H₂Te. The increase in acidic character can be explained in terms of decrease in bond (H–E) dissociation enthalpy down the group. Owing to the decrease in bond (H–E) dissociation enthalpy down the group, the thermal stability of hydrides also decreases from H₂O to H₂Po. All the hydrides except water possess reducing property and this character increases from H₂S to H₂Te.

Table 7.7: Properties of Hydrides of Group 16 Elements

Property	H ₂ O	H ₂ S	H ₂ Se	H ₂ Te
m.p/K	273	188	208	222
b.p/K	373	213	232	269
H-E distance/pm	96	134	146	169
HEH angle (°)	104	92	91	90
$\Delta_f H/\text{kJ mol}^{-1}$	-286	-20	73	100
$\Delta_{\text{diss}} H (H-E)/\text{kJ mol}^{-1}$	463	347	276	238
Dissociation constant ^a	1.8×10^{-16}	1.3×10^{-7}	1.3×10^{-4}	2.3×10^{-3}

^a Aqueous solution, 298 K

- (ii) *Reactivity with oxygen:* All these elements form oxides of the EO₂ and EO₃ types where E = S, Se, Te or Po. Ozone (O₃) and sulphur dioxide (SO₂) are gases while selenium dioxide (SeO₂) is solid. Reducing property of dioxide decreases from SO₂ to TeO₂; SO₂ is reducing while TeO₂ is an oxidising agent. Besides EO₂ type, sulphur, selenium and tellurium also form EO₃ type oxides (SO₃, SeO₃, TeO₃). Both types of oxides are acidic in nature.
- (iii) *Reactivity towards the halogens:* Elements of Group 16 form a large number of halides of the type, EX₆, EX₄ and EX₂ where E is an element of the group and X is a halogen. The stability of the halides decreases in the order F⁻ > Cl⁻ > Br⁻ > I⁻. Amongst hexahalides, hexafluorides are the only stable halides. All hexafluorides are gaseous in nature. They have octahedral structure. Sulphur hexafluoride, SF₆ is exceptionally stable for steric reasons.

Amongst tetrafluorides, SF₄ is a gas, SeF₄ a liquid and TeF₄ a solid. These fluorides have sp³d hybridisation and thus, have trigonal bipyramidal structures in which one of the equatorial positions is occupied by a lone pair of electrons. This geometry is also regarded as *see-saw* geometry.

All elements except selenium form dichlorides and dibromides. These dihalides are formed by sp³ hybridisation and thus, have tetrahedral structure. The well known monohalides are dimeric in nature. Examples are S₂F₂, S₂Cl₂, S₂Br₂, Se₂Cl₂ and Se₂Br₂. These dimeric halides undergo disproportionation as given below:



H₂S is less acidic than H₂Te. Why?

Example 7.11

Due to the decrease in bond (E-H) dissociation enthalpy down the group, acidic character increases.

Solution

Intext Questions

7.13 List the important sources of sulphur.

7.14 Write the order of thermal stability of the hydrides of Group 16 elements.

7.15 Why is H₂O a liquid and H₂S a gas ?

7.11 Dioxygen

Preparation

Dioxygen can be obtained in the laboratory by the following ways:

- (i) By heating oxygen containing salts such as chlorates, nitrates and permanganates.

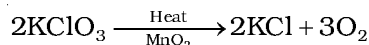

- (ii) By the thermal decomposition of the oxides of metals low in the electrochemical series and higher oxides of some metals.



- (iii) Hydrogen peroxide is readily decomposed into water and dioxygen by catalysts such as finely divided metals and manganese dioxide.

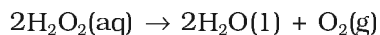

- (iv) On large scale it can be prepared from water or air. Electrolysis of water leads to the release of hydrogen at the cathode and oxygen at the anode.

Industrially, dioxygen is obtained from air by first removing carbon dioxide and water vapour and then, the remaining gases are liquefied and fractionally distilled to give dinitrogen and dioxygen.

Properties

Dioxygen is a colourless and odourless gas. Its solubility in water is to the extent of 3.08 cm^3 in 100 cm^3 water at 293 K which is just sufficient for the vital support of marine and aquatic life. It liquefies at 90 K and freezes at 55 K. It has three stable isotopes: ^{16}O , ^{17}O and ^{18}O . Molecular oxygen, O_2 is unique in being paramagnetic inspite of having even number of electrons (see Class XI Chemistry Book, Unit 4).

Dioxygen directly reacts with nearly all metals and non-metals except some metals (e.g., Au, Pt) and some noble gases. Its combination with other elements is often strongly exothermic which helps in sustaining the reaction. However, to initiate the reaction, some external heating is required as bond dissociation enthalpy of oxygen-oxygen double bond is high ($493.4 \text{ kJ mol}^{-1}$).

Some of the reactions of dioxygen with metals, non-metals and other compounds are given below:

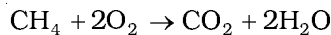
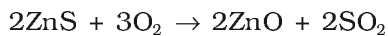
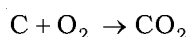
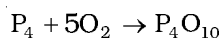
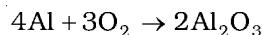
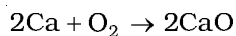

Some compounds are catalytically oxidised. For e.g.,

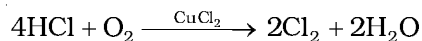
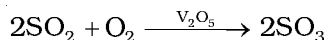

Uses: In addition to its importance in normal respiration and combustion processes, oxygen is used in oxyacetylene welding, in the manufacture of many metals, particularly steel. Oxygen cylinders are widely used in hospitals, high altitude flying and in mountaineering. The combustion of fuels, e.g., hydrazines in liquid oxygen, provides tremendous thrust in rockets.

Intext Questions

7.16 Which of the following does not react with oxygen directly?

Zn, Ti, Pt, Fe

7.17 Complete the following reactions:

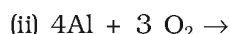
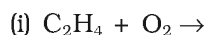

7.12 Simple Oxides

A binary compound of oxygen with another element is called oxide. As already stated, oxygen reacts with most of the elements of the periodic table to form oxides. In many cases one element forms two or more oxides. The oxides vary widely in their nature and properties.

Oxides can be simple (e.g., MgO, Al₂O₃) or mixed (Pb₃O₄, Fe₃O₄). Simple oxides can be classified on the basis of their acidic, basic or amphoteric character. An oxide that combines with water to give an acid is termed acidic oxide (e.g., SO₂, Cl₂O₇, CO₂, N₂O₅). For example, SO₂ combines with water to give H₂SO₃, an acid.

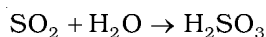

As a general rule, only non-metal oxides are acidic but oxides of some metals in high oxidation state also have acidic character (e.g., Mn₂O₇, CrO₃, V₂O₅). The oxides which give a base with water are known as basic oxides (e.g., Na₂O, CaO, BaO). For example, CaO combines with water to give Ca(OH)₂, a base.

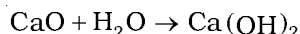

In general, metallic oxides are basic.

Some metallic oxides exhibit a dual behaviour. They show characteristics of both acidic as well as basic oxides. Such oxides are known as amphoteric oxides. They react with acids as well as alkalies. There are some oxides which are neither acidic nor basic. Such oxides are known as neutral oxides. Examples of neutral oxides are CO, NO and N₂O. For example, Al₂O₃ reacts with acids as well as alkalies.

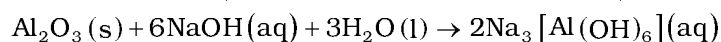
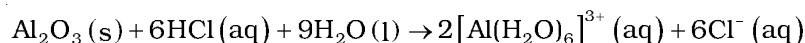

7.13 Ozone

Ozone is an allotropic form of oxygen. It is too reactive to remain for long in the atmosphere at sea level. At a height of about 20 kilometres, it is formed from atmospheric oxygen in the presence of sunlight. This ozone layer protects the earth's surface from an excessive concentration of ultraviolet (UV) radiations.

Preparation

When a slow dry stream of oxygen is passed through a silent electrical discharge, conversion of oxygen to ozone (10%) occurs. The product is known as ozonised oxygen.

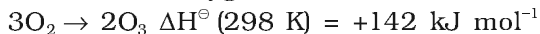

Since the formation of ozone from oxygen is an endothermic process, it is necessary to use a silent electrical discharge in its preparation to prevent its decomposition.

If concentrations of ozone greater than 10 per cent are required, a battery of ozonisers can be used, and pure ozone (b.p. 385 K) can be condensed in a vessel surrounded by liquid oxygen.

Properties

Pure ozone is a pale blue gas, dark blue liquid and violet-black solid. Ozone has a characteristic smell and in small concentrations it is harmless. However, if the concentration rises above about 100 parts per million, breathing becomes uncomfortable resulting in headache and nausea.

Ozone is thermodynamically unstable with respect to oxygen since its decomposition into oxygen results in the liberation of heat (ΔH is negative) and an increase in entropy (ΔS is positive). These two effects reinforce each other, resulting in large negative Gibbs energy change (ΔG) for its conversion into oxygen. It is not really surprising, therefore, high concentrations of ozone can be dangerously explosive.

Due to the ease with which it liberates atoms of nascent oxygen ($\text{O}_3 \rightarrow \text{O}_2 + \text{O}$), it acts as a powerful oxidising agent. For e.g., it oxidises lead sulphide to lead sulphate and iodide ions to iodine.

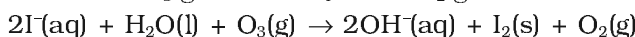
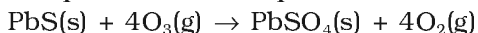

When ozone reacts with an excess of potassium iodide solution buffered with a borate buffer (pH 9.2), iodine is liberated which can be titrated against a standard solution of sodium thiosulphate. This is a quantitative method for estimating O_3 gas.

Experiments have shown that nitrogen oxides (particularly nitric oxide) combine very rapidly with ozone and there is, thus, the possibility that nitrogen oxides emitted from the exhaust systems of supersonic jet aeroplanes might be slowly depleting the concentration of the ozone layer in the upper atmosphere.

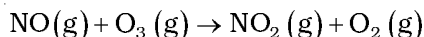

Another threat to this ozone layer is probably posed by the use of freons which are used in aerosol sprays and as refrigerants.

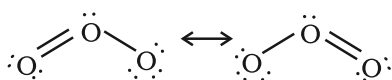

The two oxygen-oxygen bond lengths in the ozone molecule are identical (128 pm) and the molecule is angular as expected with a bond angle of about 117° . It is a resonance hybrid of two main forms:

Uses: It is used as a germicide, disinfectant and for sterilising water. It is also used for bleaching oils, ivory, flour, starch, etc. It acts as an oxidising agent in the manufacture of potassium permanganate.

Intext Questions

7.18 Why does O_3 act as a powerful oxidising agent?

7.19 How is O_3 estimated quantitatively?

7.14 Sulphur — Allotropic Forms

Sulphur forms numerous allotropes of which the **yellow rhombic** (α -sulphur) and **monoclinic** (β -sulphur) forms are the most important. The stable form at room temperature is rhombic sulphur, which transforms to monoclinic sulphur when heated above 369 K.

Rhombic sulphur (α -sulphur)

This allotrope is yellow in colour, m.p. 385.8 K and specific gravity 2.06. Rhombic sulphur crystals are formed on evaporating the solution of roll sulphur in CS_2 . It is insoluble in water but dissolves to some extent in benzene, alcohol and ether. It is readily soluble in CS_2 .

Monoclinic sulphur (β -sulphur)

Its m.p. is 393 K and specific gravity 1.98. It is soluble in CS_2 . This form of sulphur is prepared by melting rhombic sulphur in a dish and cooling, till crust is formed. Two holes are made in the crust and the remaining liquid poured out. On removing the crust, colourless needle shaped crystals of β -sulphur are formed. It is stable above 369 K and transforms into α -sulphur below it. Conversely, α -sulphur is stable below 369 K and transforms into β -sulphur above this. At 369 K both the forms are stable. This temperature is called transition temperature.

Both rhombic and monoclinic sulphur have S_8 molecules. These S_8 molecules are packed to give different crystal structures. The S_8 ring in both the forms is puckered and has a crown shape. The molecular dimensions are given in Fig. 7.5(a).

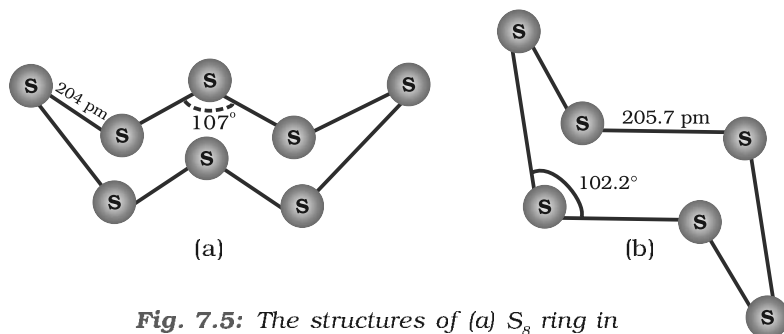

Fig. 7.5: The structures of (a) S_8 ring in rhombic sulphur and (b) S_6 form

Several other modifications of sulphur containing 6-20 sulphur atoms per ring have been synthesised in the last two decades. In cyclo- S_6 , the ring adopts the chair form and the molecular dimensions are as shown in Fig. 7.5 (b). At elevated temperatures (~ 1000 K), S_2 is the dominant species and is paramagnetic like O_2 .

Which form of sulphur shows paramagnetic behaviour ?

Example 7.12

In vapour state sulphur partly exists as S_2 molecule which has two unpaired electrons in the antibonding π^* orbitals like O_2 and, hence, exhibits paramagnetism.

Solution

7.15 Sulphur Dioxide

Preparation

Sulphur dioxide is formed together with a little (6-8%) sulphur trioxide when sulphur is burnt in air or oxygen:

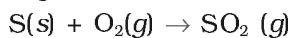

In the laboratory it is readily generated by treating a sulphite with dilute sulphuric acid.

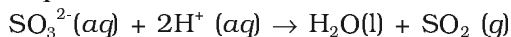

Industrially, it is produced as a by-product of the roasting of sulphide ores.

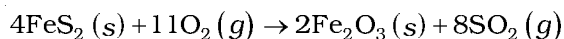

The gas after drying is liquefied under pressure and stored in steel cylinders.

Properties

Sulphur dioxide is a colourless gas with pungent smell and is highly soluble in water. It liquefies at room temperature under a pressure of two atmospheres and boils at 263 K.

Sulphur dioxide, when passed through water, forms a solution of sulphurous acid.

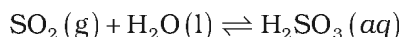

It reacts readily with sodium hydroxide solution, forming sodium sulphite, which then reacts with more sulphur dioxide to form sodium hydrogen sulphite.

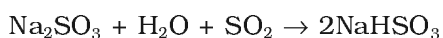
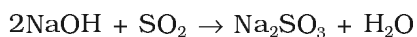

In its reaction with water and alkalies, the behaviour of sulphur dioxide is very similar to that of carbon dioxide.

Sulphur dioxide reacts with chlorine in the presence of charcoal (which acts as a catalyst) to give sulphuryl chloride, SO_2Cl_2 . It is oxidised to sulphur trioxide by oxygen in the presence of vanadium(V) oxide catalyst.

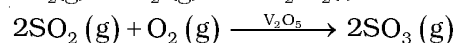
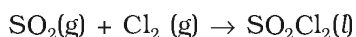

When moist, sulphur dioxide behaves as a reducing agent. For example, it converts iron(III) ions to iron(II) ions and decolourises acidified potassium permanganate(VII) solution; the latter reaction is a convenient test for the gas.

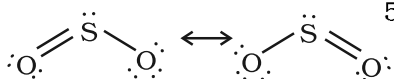
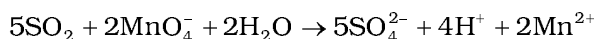
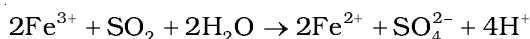

The molecule of SO_2 is angular. It is a resonance hybrid of the two canonical forms:

Uses: Sulphur dioxide is used (i) in refining petroleum and sugar (ii) in bleaching wool and silk and (iii) as an anti-chlor, disinfectant and preservative. Sulphuric acid, sodium hydrogen sulphite and calcium hydrogen sulphite (industrial chemicals) are manufactured from sulphur dioxide. Liquid SO_2 is used as a solvent to dissolve a number of organic and inorganic chemicals.

Intext Questions

- 7.20 What happens when sulphur dioxide is passed through an aqueous solution of Fe(III) salt?
- 7.21 Comment on the nature of two S–O bonds formed in SO₂ molecule. Are the two S–O bonds in this molecule equal ?
- 7.22 How is the presence of SO₂ detected ?

7.16 Oxoacids of Sulphur

Sulphur forms a number of oxoacids such as H₂SO₃, H₂S₂O₃, H₂S₂O₄, H₂S₂O₅, H₂S_xO₆ (x = 2 to 5), H₂SO₄, H₂S₂O₇, H₂SO₅, H₂S₂O₈. Some of these acids are unstable and cannot be isolated. They are known in aqueous solution or in the form of their salts. Structures of some important oxoacids are shown in Fig. 7.6.

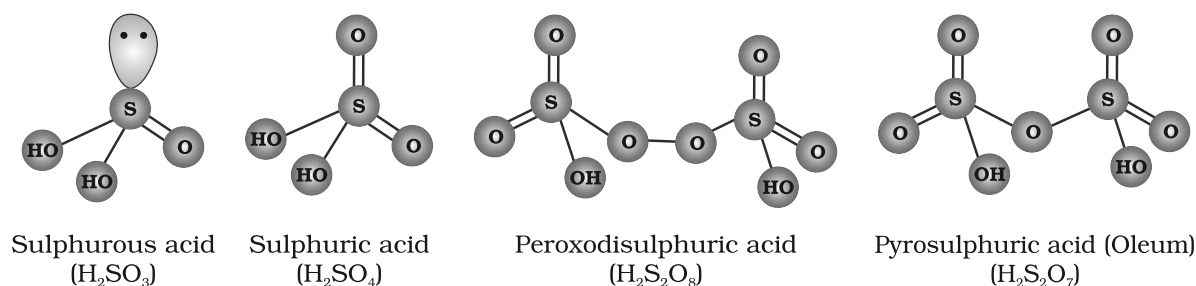

Fig. 7.6: Structures of some important oxoacids of sulphur

7.17 Sulphuric Acid

Manufacture

Sulphuric acid is one of the most important industrial chemicals worldwide.

Sulphuric acid is manufactured by the **Contact Process** which involves three steps:

- burning of sulphur or sulphide ores in air to generate SO₂.
- conversion of SO₂ to SO₃ by the reaction with oxygen in the presence of a catalyst (V₂O₅), and
- absorption of SO₃ in H₂SO₄ to give *Oleum* (H₂S₂O₇).

A flow diagram for the manufacture of sulphuric acid is shown in (Fig. 7.7). The SO₂ produced is purified by removing dust and other impurities such as arsenic compounds.

The key step in the manufacture of H₂SO₄ is the catalytic oxidation of SO₂ with O₂ to give SO₃ in the presence of V₂O₅ (catalyst).

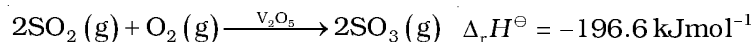

The reaction is exothermic, reversible and the forward reaction leads to a decrease in volume. Therefore, low temperature and high pressure are the favourable conditions for maximum yield. But the temperature should not be very low otherwise rate of reaction will become slow.

In practice, the plant is operated at a pressure of 2 bar and a temperature of 720 K. The SO₃ gas from the catalytic converter is

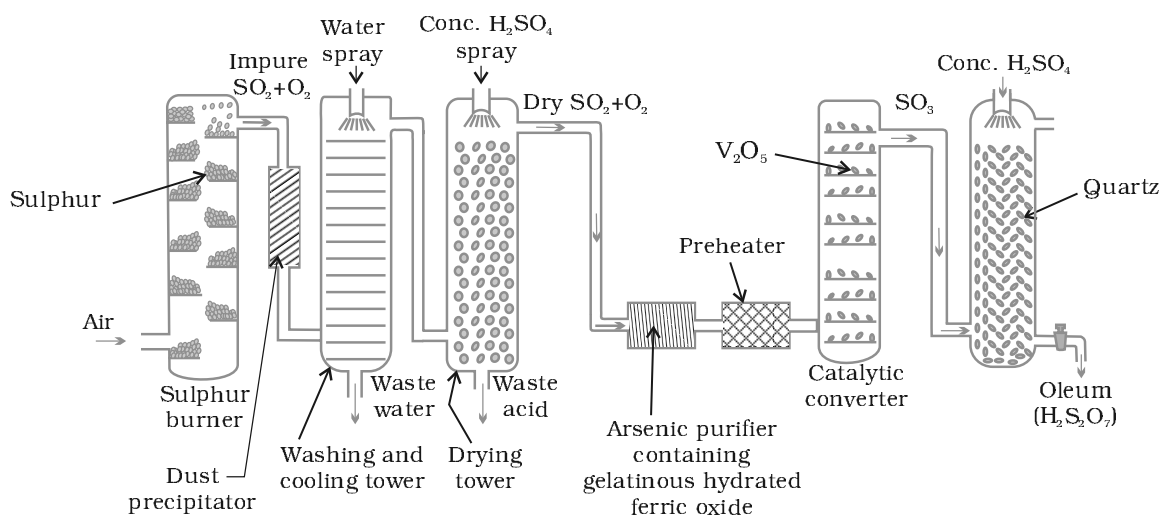
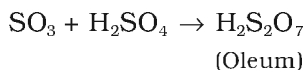

Fig. 7.7: Flow diagram for the manufacture of sulphuric acid

absorbed in concentrated H_2SO_4 to produce *oleum*. Dilution of oleum with water gives H_2SO_4 of the desired concentration. In the industry two steps are carried out simultaneously to make the process a continuous one and also to reduce the cost.



The sulphuric acid obtained by Contact process is 96-98% pure.

Properties

Sulphuric acid is a colourless, dense, oily liquid with a specific gravity of 1.84 at 298 K. The acid freezes at 283 K and boils at 611 K. It dissolves in water with the evolution of a large quantity of heat. Hence, care must be taken while preparing sulphuric acid solution from concentrated sulphuric acid. The concentrated acid must be added slowly into water with constant stirring.

The chemical reactions of sulphuric acid are as a result of the following characteristics: (a) low volatility (b) strong acidic character (c) strong affinity for water and (d) ability to act as an oxidising agent. In aqueous solution, sulphuric acid ionises in two steps.

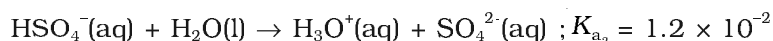

The larger value of K_{a_1} ($K_{a_1} > 10$) means that H_2SO_4 is largely dissociated into H^+ and HSO_4^- . Greater the value of dissociation constant (K_s), the stronger is the acid.

The acid forms two series of salts: normal sulphates (such as sodium sulphate and copper sulphate) and acid sulphates (e.g., sodium hydrogen sulphate).

Sulphuric acid, because of its low volatility can be used to manufacture more volatile acids from their corresponding salts.

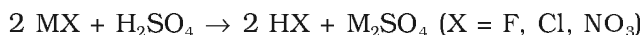

(M = Metal)

Concentrated sulphuric acid is a strong dehydrating agent. Many wet gases can be dried by passing them through sulphuric acid, provided the gases do not react with the acid. Sulphuric acid removes water from organic compounds; it is evident by its charring action on carbohydrates.

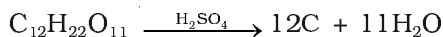

Hot concentrated sulphuric acid is a moderately strong oxidising agent. In this respect, it is intermediate between phosphoric and nitric acids. Both metals and non-metals are oxidised by concentrated sulphuric acid, which is reduced to SO_2 .

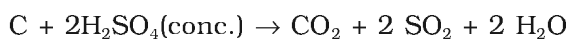
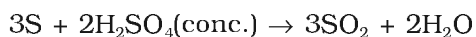
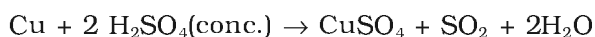

Uses: Sulphuric acid is a very important industrial chemical. A nation's industrial strength can be judged by the quantity of sulphuric acid it produces and consumes. It is needed for the manufacture of hundreds of other compounds and also in many industrial processes. The bulk of sulphuric acid produced is used in the manufacture of fertilisers (e.g., ammonium sulphate, superphosphate). Other uses are in: (a) petroleum refining (b) manufacture of pigments, paints and dyestuff intermediates (c) detergent industry (d) metallurgical applications (e.g., cleansing metals before enameling, electroplating and galvanising (e) storage batteries (f) in the manufacture of nitrocellulose products and (g) as a laboratory reagent.

Intext Questions

- 7.23** Mention three areas in which H_2SO_4 plays an important role.
- 7.24** Write the conditions to maximise the yield of H_2SO_4 by Contact process.
- 7.25** Why is $K_{a_2} \ll K_{a_1}$ for H_2SO_4 in water ?

7.18 Group 17 Elements

Fluorine, chlorine, bromine, iodine and astatine are members of Group 17. These are collectively known as the **halogens** (Greek *halo* means salt and *genes* means born i.e., salt producers). The halogens are highly reactive non-metallic elements. Like Groups 1 and 2, the elements of Group 17 show great similarity amongst themselves. That much similarity is not found in the elements of other groups of the periodic table. Also, there is a regular gradation in their physical and chemical properties. Astatine is a radioactive element.

7.18.1 Occurrence Fluorine and chlorine are fairly abundant while bromine and iodine less so. Fluorine is present mainly as insoluble fluorides (fluorspar CaF_2 , cryolite Na_3AlF_6 and fluoroapatite $3\text{Ca}_3(\text{PO}_4)_2 \cdot \text{CaF}_2$) and small quantities are present in soil, river water plants and bones and teeth of animals. Sea water contains chlorides, bromides and iodides of sodium, potassium, magnesium and calcium, but is mainly sodium chloride solution (2.5% by mass). The deposits of dried up seas contain these compounds, e.g., sodium chloride and carnallite, $\text{KCl} \cdot \text{MgCl}_2 \cdot 6\text{H}_2\text{O}$. Certain forms of marine life contain iodine in their systems; various seaweeds, for example, contain upto 0.5% of iodine and Chile saltpetre contains upto 0.2% of sodium iodate.

The important atomic and physical properties of Group 17 elements along with their electronic configurations are given in Table 7.8.

Table 7.8: Atomic and Physical Properties of Halogens

Property	F	Cl	Br	I	At ^a
Atomic number	9	17	35	53	85
Atomic mass/g mol ⁻¹	19.00	35.45	79.90	126.90	210
Electronic configuration	$[\text{He}]2s^22p^5$	$[\text{Ne}]3s^23p^5$	$[\text{Ar}]3d^{10}4s^24p^5$	$[\text{Kr}]4d^{10}5s^25p^5$	$[\text{Xe}]4f^{14}5d^{10}6s^26p^5$
Covalent radius/pm	64	99	114	133	–
Ionic radius X ⁻ /pm	133	184	196	220	–
Ionisation enthalpy/kJ mol ⁻¹	1680	1256	1142	1008	–
Electron gain enthalpy/kJ mol ⁻¹	-333	-349	-325	-296	–
Electronegativity ^b	4	3.2	3.0	2.7	2.2
$\Delta_{\text{hyd}}H(X^-)/\text{kJ mol}^{-1}$	515	381	347	305	–
	F₂	Cl₂	Br₂	I₂	–
Melting point/K	54.4	172.0	265.8	386.6	–
Boiling point/K	84.9	239.0	332.5	458.2	–
Density/g cm ⁻³	1.5 (85) ^c	1.66 (203) ^c	3.19(273) ^c	4.94(293) ^d	–
Distance X – X/pm	143	199	228	266	–
Bond dissociation enthalpy (kJ mol ⁻¹)	158.8	242.6	192.8	151.1	–
E^\ominus/V^e	2.87	1.36	1.09	0.54	–

^a Radioactive; ^b Pauling scale; ^c For the liquid at temperatures (K) given in the parentheses; ^d solid; ^e The half-cell reaction is $\text{X}_2(\text{g}) + 2\text{e}^- \rightarrow 2\text{X}(\text{aq})$.

The trends of some of the atomic, physical and chemical properties are discussed below.

- 7.18.2 Electronic Configuration** All these elements have seven electrons in their outermost shell (ns^2np^5) which is one electron short of the next noble gas.
- 7.18.3 Atomic and Ionic Radii** The halogens have the smallest atomic radii in their respective periods due to maximum effective nuclear charge. The atomic radius of fluorine like the other elements of second period is extremely small. Atomic and ionic radii increase from fluorine to iodine due to increasing number of quantum shells.
- 7.18.4 Ionisation Enthalpy** They have little tendency to lose electron. Thus they have very high ionisation enthalpy. Due to increase in atomic size, ionisation enthalpy decreases down the group.
- 7.18.5 Electron Gain Enthalpy** Halogens have maximum negative electron gain enthalpy in the corresponding periods. This is due to the fact that the atoms of these elements have only one electron less than stable noble gas configurations. Electron gain enthalpy of the elements of the group becomes less negative down the group. However, the negative electron gain enthalpy of fluorine is less than that of chlorine. It is due to small size of fluorine atom. As a result, there are strong interelectronic repulsions in the relatively small $2p$ orbitals of fluorine and thus, the incoming electron does not experience much attraction.
- 7.18.6 Electronegativity** They have very high electronegativity. The electronegativity decreases down the group. Fluorine is the most electronegative element in the periodic table.

Halogens have maximum negative electron gain enthalpy in the *Example 7.14* respective periods of the periodic table. Why?

Halogens have the smallest size in their respective periods and therefore *Solution* high effective nuclear charge. As a consequence, they readily accept one electron to acquire noble gas electronic configuration.

- 7.18.7 Physical Properties** Halogens display smooth variations in their physical properties. Fluorine and chlorine are gases, bromine is a liquid and iodine is a solid. Their melting and boiling points steadily increase with atomic number. All halogens are coloured. This is due to absorption of radiations in visible region which results in the excitation of outer electrons to higher energy level. By absorbing different quanta of radiation, they display different colours. For example, F_2 , has yellow, Cl_2 , greenish yellow, Br_2 , red and I_2 , violet colour. Fluorine and chlorine react with water. Bromine and iodine are only sparingly soluble in water but are soluble in various organic solvents such as chloroform, carbon tetrachloride, carbon disulphide and hydrocarbons to give coloured solutions.

One curious anomaly we notice from Table 7.8 is the smaller enthalpy of dissociation of F_2 compared to that of Cl_2 whereas X-X bond dissociation enthalpies from chlorine onwards show the expected

trend: $\text{Cl} - \text{Cl} > \text{Br} - \text{Br} > \text{I} - \text{I}$. A reason for this anomaly is the relatively large electron-electron repulsion among the lone pairs in F_2 molecule where they are much closer to each other than in case of Cl_2 .

Example 7.15

Although electron gain enthalpy of fluorine is less negative as compared to chlorine, fluorine is a stronger oxidising agent than chlorine. Why?

Solution

It is due to

- (i) low enthalpy of dissociation of F-F bond (Table 7.8).
- (ii) high hydration enthalpy of F^- (Table 7.8).

7.18.8 Chemical Properties

Oxidation states and trends in chemical reactivity

All the halogens exhibit -1 oxidation state. However, chlorine, bromine and iodine exhibit $+1$, $+3$, $+5$ and $+7$ oxidation states also as explained below:

Halogen atom in ground state (other than fluorine)	ns	np	nd	
	$\uparrow\downarrow$	$\uparrow\downarrow \uparrow\downarrow \uparrow$	$\square \square \square \square$	1 unpaired electron accounts for -1 or $+1$ oxidation states
First excited state	$\uparrow\downarrow$	$\uparrow\downarrow \uparrow \uparrow$	$\uparrow \square \square \square$	3 unpaired electrons account for $+3$ oxidation states
Second excited state	$\uparrow\downarrow$	$\uparrow \uparrow \uparrow$	$\uparrow \uparrow \square \square$	5 unpaired electrons account for $+5$ oxidation state
Third excited state	$\uparrow\downarrow$	$\uparrow \uparrow \uparrow$	$\uparrow \uparrow \uparrow \square$	7 unpaired electrons account for $+7$ oxidation state

The higher oxidation states of chlorine, bromine and iodine are realised mainly when the halogens are in combination with the small and highly electronegative fluorine and oxygen atoms. e.g., in interhalogens, oxides and oxoacids. The oxidation states of $+4$ and $+6$ occur in the oxides and oxoacids of chlorine and bromine. The fluorine atom has no d orbitals in its valence shell and therefore cannot expand its octet. Being the most electronegative, it exhibits only -1 oxidation state.

All the halogens are highly reactive. They react with metals and non-metals to form halides. The reactivity of the halogens decreases down the group.

The ready acceptance of an electron is the reason for the strong oxidising nature of halogens. F_2 is the strongest oxidising halogen and it oxidises other halide ions in solution or even in the solid phase. In general, a halogen oxidises halide ions of higher atomic number.

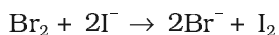
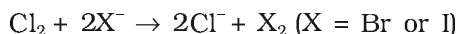
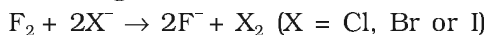

The decreasing oxidising ability of the halogens in aqueous solution down the group is evident from their standard electrode potentials (Table 7.8) which are dependent on the parameters indicated below:

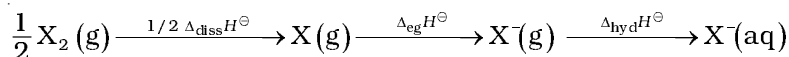

The relative oxidising power of halogens can further be illustrated by their reactions with water. Fluorine oxidises water to oxygen whereas chlorine and bromine react with water to form corresponding hydrohalic and hypohalous acids. The reaction of iodine with water is non-spontaneous. In fact, I^- can be oxidised by oxygen in acidic medium; just the reverse of the reaction observed with fluorine.

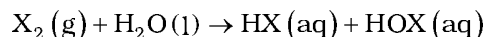
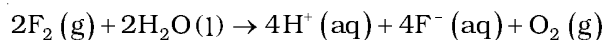

(where X = Cl or Br)

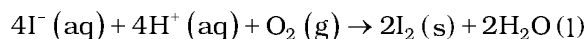

Anomalous behaviour of fluorine

Like other elements of *p*-block present in second period of the periodic table, fluorine is anomalous in many properties. For example, ionisation enthalpy, electronegativity, enthalpy of bond dissociation and electrode potentials are all higher for fluorine than expected from the trends set by other halogens. Also, ionic and covalent radii, m.p. and b.p. and electron gain enthalpy are quite lower than expected. The anomalous behaviour of fluorine is due to its small size, highest electronegativity, low F-F bond dissociation enthalpy, and non availability of *d* orbitals in valence shell.

Most of the reactions of fluorine are exothermic (due to the small and strong bond formed by it with other elements). It forms only one oxoacid while other halogens form a number of oxoacids. Hydrogen fluoride is a liquid (b.p. 293 K) due to strong hydrogen bonding. Other hydrogen halides are gases.

- (i) *Reactivity towards hydrogen*: They all react with hydrogen to give hydrogen halides but affinity for hydrogen decreases from fluorine to iodine. They dissolve in water to form hydrohalic acids. Some of the properties of hydrogen halides are given in Table 7.9. The acidic strength of these acids varies in the order: HF < HCl < HBr < HI. The stability of these halides decreases down the group due to decrease in bond (H-X) dissociation enthalpy in the order: H-F > H-Cl > H-Br > H-I.

Table 7.9: Properties of Hydrogen Halides

Property	HF	HCl	HBr	HI
Melting point/K	190	159	185	222
Boiling point/K	293	189	206	238
Bond length (H - X)/pm	91.7	127.4	141.4	160.9
$\Delta_{\text{diss}} H^\ominus / \text{kJ mol}^{-1}$	574	432	363	295
pK_a	3.2	-7.0	-9.5	-10.0

- (ii) *Reactivity towards oxygen*: Halogens form many oxides with oxygen but most of them are unstable. Fluorine forms two oxides OF_2 and O_2F_2 . However, only OF_2 is thermally stable at 298 K. These oxides

are essentially oxygen fluorides because of the higher electronegativity of fluorine than oxygen. Both are strong fluorinating agents. O_2F_2 oxidises plutonium to PuF_6 and the reaction is used in removing plutonium as PuF_6 from spent nuclear fuel.

Chlorine, bromine and iodine form oxides in which the oxidation states of these halogens range from +1 to +7. A combination of kinetic and thermodynamic factors lead to the generally decreasing order of stability of oxides formed by halogens, $I > Cl > Br$. The higher oxides of halogens tend to be more stable than the lower ones.

Chlorine oxides, Cl_2O , ClO_2 , Cl_2O_6 and Cl_2O_7 are highly reactive oxidising agents and tend to explode. ClO_2 is used as a bleaching agent for paper pulp and textiles and in water treatment.

The bromine oxides, Br_2O , BrO_2 , BrO_3 are the least stable halogen oxides (middle row anomaly) and exist only at low temperatures. They are very powerful oxidising agents.

The iodine oxides, I_2O_4 , I_2O_5 , I_2O_7 are insoluble solids and decompose on heating. I_2O_5 is a very good oxidising agent and is used in the estimation of carbon monoxide.

- (iii) *Reactivity towards metals*: Halogens react with metals to form metal halides. For e.g., bromine reacts with magnesium to give magnesium bromide.

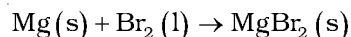

The ionic character of the halides decreases in the order $MF > MCl > MBr > MI$ where M is a monovalent metal. If a metal exhibits more than one oxidation state, the halides in higher oxidation state will be more covalent than the one in lower oxidation state. For e.g., $SnCl_4$, $PbCl_4$, $SbCl_5$ and UF_6 are more covalent than $SnCl_2$, $PbCl_2$, $SbCl_3$ and UF_4 respectively.

- (iv) *Reactivity of halogens towards other halogens*: Halogens combine amongst themselves to form a number of compounds known as interhalogens of the types XX' , XX'_3 , XX'_5 and XX'_7 where X is a larger size halogen and X' is smaller size halogen.

Example 7.16 Fluorine exhibits only -1 oxidation state whereas other halogens exhibit + 1, + 3, + 5 and + 7 oxidation states also. Explain.

Solution Fluorine is the most electronegative element and cannot exhibit any positive oxidation state. Other halogens have *d* orbitals and therefore, can expand their octets and show + 1, + 3, + 5 and + 7 oxidation states also.

Intext Questions

- 7.26** Considering the parameters such as bond dissociation enthalpy, electron gain enthalpy and hydration enthalpy, compare the oxidising power of F_2 and Cl_2 .
- 7.27** Give two examples to show the anomalous behaviour of fluorine.
- 7.28** Sea is the greatest source of some halogens. Comment.

Preparation

In laboratory, it is prepared by heating sodium chloride with concentrated sulphuric acid.

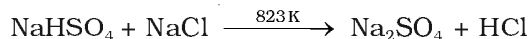
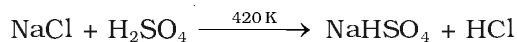

HCl gas can be dried by passing through concentrated sulphuric acid.

Properties

It is a colourless and pungent smelling gas. It is easily liquefied to a colourless liquid (b.p. 189 K) and freezes to a white crystalline solid (f.p. 159 K). It is extremely soluble in water and ionises as below:

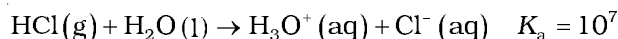

Its aqueous solution is called hydrochloric acid. High value of dissociation constant (K_a) indicates that it is a strong acid in water. It reacts with NH_3 and gives white fumes of NH_4Cl .

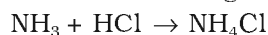

When three parts of concentrated HCl and one part of concentrated HNO_3 are mixed, aqua regia is formed which is used for dissolving noble metals, e.g., gold, platinum.

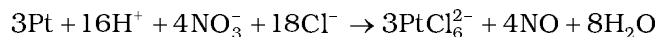
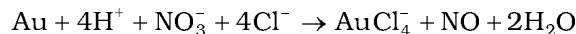

Hydrochloric acid decomposes salts of weaker acids, e.g., carbonates, hydrogencarbonates, sulphites, etc.

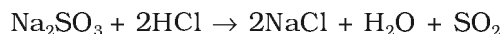
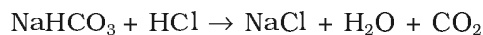
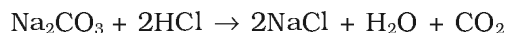

Uses: It is used (i) in the manufacture of chlorine, NH_4Cl and glucose (from corn starch), (ii) for extracting glue from bones and purifying bone black, (iii) in medicine and as a laboratory reagent.

When HCl reacts with finely powdered iron, it forms ferrous chloride and not ferric chloride. Why?

Example 7.18

Its reaction with iron produces H_2 .

Solution

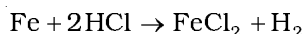

Liberation of hydrogen prevents the formation of ferric chloride.

7.21 Oxoacids of Halogens

Due to high electronegativity and small size, fluorine forms only one oxoacid, HOF known as fluoric (I) acid or hypofluorous acid. The other halogens form several oxoacids. Most of them cannot be isolated in pure state. They are stable only in aqueous solutions or in the form of their salts. The oxoacids of halogens are given in Table 7.10 and their structures are given in Fig. 7.8.

Table 7.10: Oxoacids of Halogens

Halic (I) acid (Hypohalous acid)	HOF (Hypofluorous acid)	HOCl (Hypochlorous acid)	HOBr (Hypobromous acid)	HOI (Hypoiodous acid)
Halic (III) acid (Halous acid)	- -	HOClO (chlorous acid)	- -	- -
Halic (V) acid (Halic acid)	- -	HOClO ₂ (chloric acid)	HOBrO ₂ (bromic acid)	HOIO ₂ (iodic acid)
Halic (VII) acid (Perhalic acid)	- -	HOClO ₃ (perchloric acid)	HOBrO ₃ (perbromic acid)	HOIO ₃ (periodic acid)

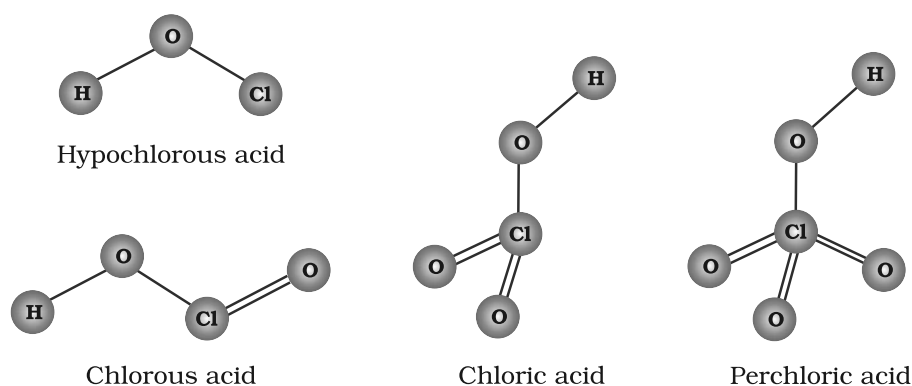

Fig. 7.8
The structures of
oxoacids of chlorine

7.22 Interhalogen Compounds

When two different halogens react with each other, interhalogen compounds are formed. They can be assigned general compositions as XX' , XX'_3 , XX'_5 and XX'_7 where X is halogen of larger size and X' of smaller size and X is more electropositive than X' . As the ratio between radii of X and X' increases, the number of atoms per molecule also increases. Thus, iodine (VII) fluoride should have maximum number of atoms as the ratio of radii between I and F should be maximum. That is why its formula is IF_7 (having maximum number of atoms).

Preparation

The interhalogen compounds can be prepared by the direct combination or by the action of halogen on lower interhalogen compounds. The product formed depends upon some specific conditions, For e.g.,

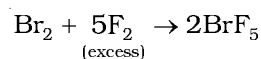
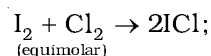
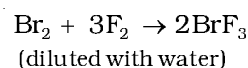
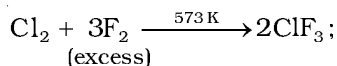
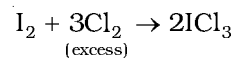
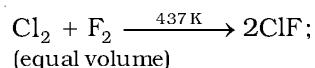

Properties

Some properties of interhalogen compounds are given in Table 7.11.

Table 7.11: Some Properties of Interhalogen Compounds

Type	Formula	Physical state and colour	Structure
XX' ₁	ClF	colourless gas	–
	BrF	pale brown gas	–
	IF ^a	detected spectroscopically	–
	BrCl ^b	gas	–
	ICl	ruby red solid (α -form)	–
		brown red solid (β -form)	–
XX' ₃	IBr	black solid	–
	ClF ₃	colourless gas	Bent T-shaped
	BrF ₃	yellow green liquid	Bent T-shaped
	IF ₃	yellow powder	Bent T-shaped (?)
	ICl ₃ ^c	orange solid	Bent T-shaped (?)
XX' ₅	IF ₅	colourless gas but solid below 77 K	Square pyramidal
	BrF ₅	colourless liquid	Square pyramidal
	ClF ₅	colourless liquid	Square pyramidal
XX' ₇	IF ₇	colourless gas	Pentagonal bipyramidal

^aVery unstable; ^bThe pure solid is known at room temperature; ^cDimerises as Cl-bridged dimer (I₂Cl₆)

These are all covalent molecules and are diamagnetic in nature. They are volatile solids or liquids except ClF which is a gas at 298 K. Their physical properties are intermediate between those of constituent halogens except that their m.p. and b.p. are a little higher than expected.

Their chemical reactions can be compared with the individual halogens. In general, interhalogen compounds are more reactive than halogens (except fluorine). This is because X–X' bond in interhalogens is weaker than X–X bond in halogens except F–F bond. All these undergo hydrolysis giving halide ion derived from the smaller halogen and a hypohalite (when XX'), halite (when XX'₃), halate (when XX'₅) and perhalate (when XX'₇) anion derived from the larger halogen.

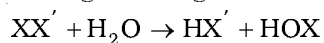

Their molecular structures are very interesting which can be explained on the basis of VSEPR theory (Example 7.19). The XX₃ compounds have the bent 'T' shape, XX₅ compounds square pyramidal and IF₇ has pentagonal bipyramidal structures (Table 7.11).

Example 7.19 Deduce the molecular shape of BrF_3 on the basis of VSEPR theory.

Solution The central atom Br has seven electrons in the valence shell. Three of these will form electron-pair bonds with three fluorine atoms leaving behind four electrons. Thus, there are three bond pairs and two lone pairs. According to VSEPR theory, these will occupy the corners of a trigonal bipyramid. The two lone pairs will occupy the equatorial positions to minimise lone pair-lone pair and the bond pair-lone pair repulsions which are greater than the bond pair-bond pair repulsions. In addition, the axial fluorine atoms will be bent towards the equatorial fluorine in order to minimise the lone-pair-lone pair repulsions. The shape would be that of a slightly bent 'T'.

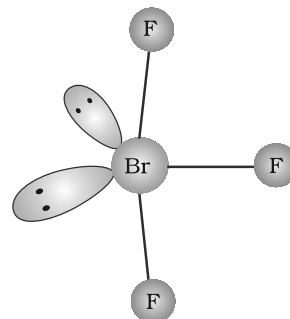

Uses: These compounds can be used as non aqueous solvents. Interhalogen compounds are very useful fluorinating agents. ClF_3 and BrF_3 are used for the production of UF_6 in the enrichment of ^{235}U .

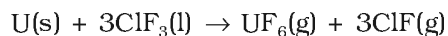

Intext Question

7.31 Why is ICl more reactive than I_2 ?

7.23 Group 18 Elements

Group 18 consists of six elements: helium, neon, argon, krypton, xenon and radon. All these are gases and chemically unreactive. They form very few compounds. Because of this they are termed noble gases.

7.23.1 Occurrence

All the noble gases except radon occur in the atmosphere. Their atmospheric abundance in dry air is $\sim 1\%$ by volume of which argon is the major constituent. Helium and sometimes neon are found in minerals of radioactive origin e.g., pitchblende, monazite, cleveite. The main commercial source of helium is natural gas. Xenon and radon are the rarest elements of the group. Radon is obtained as a decay product of ^{226}Ra .

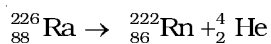

Example 7.20 Why are the elements of Group 18 known as noble gases ?

Solution The elements present in Group 18 have their valence shell orbitals completely filled and, therefore, react with a few elements only under certain conditions. Therefore, they are now known as noble gases.

The important atomic and physical properties of the Group 18 elements along with their electronic configurations are given in Table 7.12. The trends in some of the atomic, physical and chemical properties of the group are discussed here.

Table 7.12: Atomic and Physical Properties of Group 18 Elements

Property	He	Ne	Ar	Kr	Xe	Rn*
Atomic number	2	10	18	36	54	86
Atomic mass/ g mol^{-1}	4.00	20.18	39.95	83.80	131.30	222.00
Electronic configuration	$1s^2$	$[\text{He}]2s^22p^6$	$[\text{Ne}] 3s^23p^6$	$[\text{Ar}]3d^{10}4s^24p^6$	$[\text{Kr}]4d^{10}5s^25p^6$	$[\text{Xe}]4f^{14}5d^{10}6s^26p^6$
Atomic radius/pm	120	160	190	200	220	–
Ionisation enthalpy / kJmol^{-1}	2372	2080	1520	1351	1170	1037
Electron gain enthalpy / kJmol^{-1}	48	116	96	96	77	68
Density (at STP)/ gcm^{-3}	1.8×10^{-4}	9.0×10^{-4}	1.8×10^{-3}	3.7×10^{-3}	5.9×10^{-3}	9.7×10^{-3}
Melting point/K	–	24.6	83.8	115.9	161.3	202
Boiling point/K	4.2	27.1	87.2	119.7	165.0	211
Atmospheric content (% by volume)	5.24×10^{-4}	–	1.82×10^{-3}	0.934	1.14×10^{-4}	8.7×10^{-6}

* radioactive

7.23.2 Electronic Configuration

All noble gases have general electronic configuration ns^2np^6 except helium which has $1s^2$ (Table 7.12). Many of the properties of noble gases including their inactive nature are ascribed to their closed shell structures.

7.23.3 Ionisation Enthalpy

Due to stable electronic configuration these gases exhibit very high ionisation enthalpy. However, it decreases down the group with increase in atomic size.

7.23.4 Atomic Radii

Atomic radii increase down the group with increase in atomic number.

7.23.5 Electron Gain Enthalpy

Since noble gases have stable electronic configurations, they have no tendency to accept the electron and therefore, have large positive values of electron gain enthalpy.

Physical Properties

All the noble gases are monoatomic. They are colourless, odourless and tasteless. They are sparingly soluble in water. They have very low melting and boiling points because the only type of interatomic interaction in these elements is weak dispersion forces. Helium has the lowest boiling point (4.2 K) of any known substance. It has an unusual property of diffusing through most commonly used laboratory materials such as rubber, glass or plastics.

Noble gases have very low boiling points. Why?

Example 7.21

Noble gases being monoatomic have no interatomic forces except weak dispersion forces and therefore, they are liquefied at very low temperatures. Hence, they have low boiling points.

Solution

Chemical Properties

In general, noble gases are least reactive. Their inertness to chemical reactivity is attributed to the following reasons:

- (i) The noble gases except helium ($1s^2$) have completely filled ns^2np^6 electronic configuration in their valence shell.
- (ii) They have high ionisation enthalpy and more positive electron gain enthalpy.

The reactivity of noble gases has been investigated occasionally, ever since their discovery, but all attempts to force them to react to form the compounds, were unsuccessful for quite a few years. In March 1962, Neil Bartlett, then at the University of British Columbia, observed the reaction of a noble gas. First, he prepared a red compound which is formulated as $O_2^+PtF_6^-$. He, then realised that the first ionisation enthalpy of molecular oxygen (1175 kJ mol^{-1}) was almost identical with that of xenon (1170 kJ mol^{-1}). He made efforts to prepare same type of compound with Xe and was successful in preparing another red colour compound $Xe^+PtF_6^-$ by mixing PtF_6 and xenon. After this discovery, a number of xenon compounds mainly with most electronegative elements like fluorine and oxygen, have been synthesised.

The compounds of krypton are fewer. Only the difluoride (KrF_2) has been studied in detail. Compounds of radon have not been isolated but only identified (e.g., RnF_2) by radiotracer technique. No true compounds of Ar, Ne or He are yet known.

(a) Xenon-fluorine compounds

Xenon forms three binary fluorides, XeF_2 , XeF_4 and XeF_6 by the direct reaction of elements under appropriate experimental conditions.

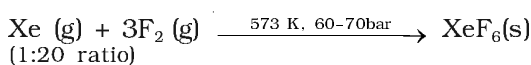
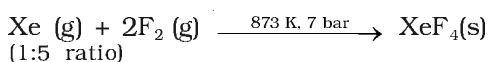
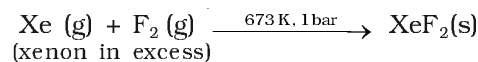

XeF_6 can also be prepared by the interaction of XeF_4 and O_2F_2 at 143K.

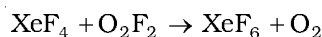

XeF_2 , XeF_4 and XeF_6 are colourless crystalline solids and sublime readily at 298 K. They are powerful fluorinating agents. They are readily hydrolysed even by traces of water. For example, XeF_2 is hydrolysed to give Xe, HF and O_2 .

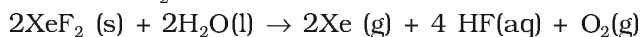

The structures of the three xenon fluorides can be deduced from VSEPR and these are shown in Fig. 7.9. XeF_2 and XeF_4 have linear and square planar structures respectively. XeF_6 has seven electron pairs (6 bonding pairs and one lone pair) and would, thus, have a distorted octahedral structure as found experimentally in the gas phase.

Xenon fluorides react with fluoride ion acceptors to form cationic species and fluoride ion donors to form fluoroanions.

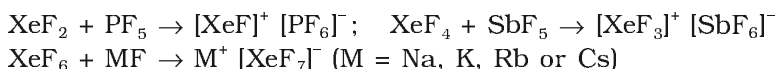

(b) Xenon-oxygen compounds

Hydrolysis of XeF_4 and XeF_6 with water gives XeO_3 .

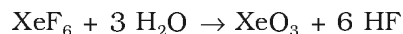
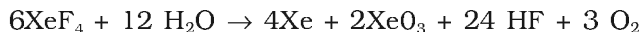

Partial hydrolysis of XeF_6 gives oxyfluorides, XeOF_4 and XeO_2F_2 .

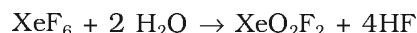
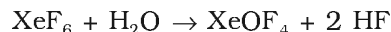

XeO_3 is a colourless explosive solid and has a pyramidal molecular structure (Fig. 7.9). XeOF_4 is a colourless volatile liquid and has a square pyramidal molecular structure (Fig. 7.9).

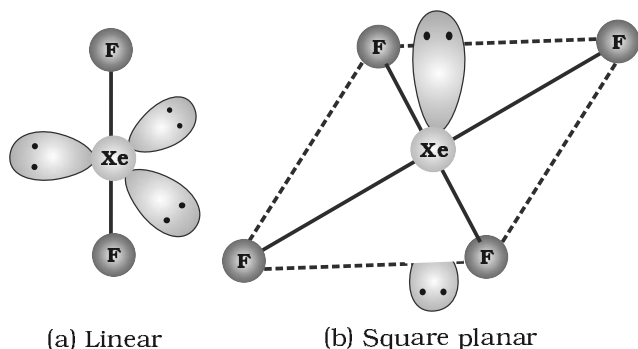

(a) Linear

(b) Square planar

Fig. 7.9

The structures of (a) XeF_2 (b) XeF_4 (c) XeF_6 (d) XeOF_4 and (e) XeO_3

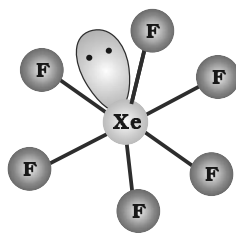

(c) Distorted octahedral

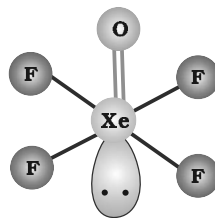

(d) Square pyramidal

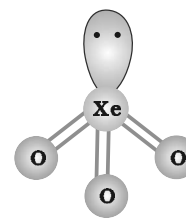

(e) Pyramidal

Does the hydrolysis of XeF_6 lead to a redox reaction?

Example 7.22

No, the products of hydrolysis are XeOF_4 and XeO_2F_2 where the oxidation states of all the elements remain the same as it was in the reacting state.

Solution

Uses: Helium is a non-inflammable and light gas. Hence, it is used in filling balloons for meteorological observations. It is also used in gas-cooled nuclear reactors. Liquid helium (b.p. 4.2 K) finds use as cryogenic agent for carrying out various experiments at low temperatures. It is used to produce and sustain powerful superconducting magnets which form an essential part of modern NMR spectrometers and Magnetic Resonance Imaging (MRI) systems for clinical diagnosis. It is used as a diluent for oxygen in modern diving apparatus because of its very low solubility in blood.

Neon is used in discharge tubes and fluorescent bulbs for advertisement display purposes. Neon bulbs are used in botanical gardens and in green houses.

Argon is used mainly to provide an inert atmosphere in high temperature metallurgical processes (arc welding of metals or alloys) and for filling electric bulbs. It is also used in the laboratory for handling substances that are air-sensitive. There are no significant uses of Xenon and Krypton. They are used in light bulbs designed for special purposes.

Intext Questions

7.32 Why is helium used in diving apparatus?

7.33 Balance the following equation: $\text{XeF}_6 + \text{H}_2\text{O} \rightarrow \text{XeO}_2\text{F}_2 + \text{HF}$

7.34 Why has it been difficult to study the chemistry of radon?

Summary

Groups 13 to 18 of the periodic table consist of **p-block elements** with their valence shell electronic configuration ns^2np^{1-6} . Groups 13 and 14 were dealt with in Class XI. In this Unit remaining groups of the p-block have been discussed.

Group 15 consists of five elements namely, N, P, As, Sb and Bi which have general electronic configuration ns^2np^3 . Nitrogen differs from other elements of this group due to small size, formation of **$p\pi-p\pi$ multiple bonds** with itself and with highly electronegative atom like O or C and **non-availability of d orbitals** to expand its valence shell. Elements of group 15 show gradation in properties. They react with oxygen, hydrogen and halogens. They exhibit two important oxidation states, +3 and +5 but +3 oxidation is favoured by heavier elements due to 'inert pair effect'.

Dinitrogen can be prepared in laboratory as well as on industrial scale. It forms oxides in various oxidation states as N_2O , NO, N_2O_3 , NO_2 , N_2O_4 and N_2O_5 . These oxides have **resonating structures** and have multiple bonds. Ammonia can be prepared on large scale by **Haber's process**. HNO_3 is an important industrial chemical. It is a strong monobasic acid and is a powerful oxidising agent. Metals and non-metals react with HNO_3 under different conditions to give NO or NO_2 .

Phosphorus exists as P_4 in elemental form. It exists in several **allotropic forms**. It forms hydride, PH_3 which is a highly poisonous gas. It forms two types of halides as PX_3 and PX_5 . PCl_3 is prepared by the reaction of white phosphorus with dry chlorine while PCl_5 is prepared by the reaction of phosphorus with SO_2Cl_2 . Phosphorus forms a number of oxoacids. Depending upon the number of P-OH groups, their basicity varies. The oxoacids which have P-H bonds are good reducing agents.

The Group 16 elements have general electronic configuration ns^2np^4 . They show maximum oxidation state, +6. Gradation in physical and chemical properties is observed in the group 16 elements. In laboratory, dioxygen is prepared by heating $KClO_3$ in presence of MnO_2 . It forms a number of oxides with metals. Allotropic form of oxygen is O_3 which is a highly oxidising agent. Sulphur forms a number of allotropes. Of these, α - and β - forms of sulphur are the most important. Sulphur combines with oxygen to give oxides such as SO_2 and SO_3 . SO_2 is prepared by the direct union of sulphur with oxygen. SO_2 is used in the manufacture of H_2SO_4 . Sulphur forms a number of oxoacids. Amongst them, most important is H_2SO_4 . It is prepared by **contact process**. It is a dehydrating and oxidising agent. It is used in the manufacture of several compounds.

Group 17 of the periodic table consists of the following elements F, Cl, Br, I and At. These elements are extremely reactive and as such they are found in the combined state only. The common oxidation state of these elements is -1. However, highest oxidation state can be +7. They show regular gradation in physical and chemical properties. They form oxides, hydrogen halides, interhalogen compounds and oxoacids. Chlorine is conveniently obtained by the reaction of HCl with $KMnO_4$. HCl is prepared by heating NaCl with concentrated H_2SO_4 . Halogens combine with one another to form **interhalogen compounds** of the type $X X'_n$ ($n = 1, 3, 5, 7$) where X' is lighter than X. A number of oxoacids of halogens are known. In the structures of these oxoacids, halogen is the central atom which is bonded in each case with one OH bond as X-OH. In some cases X = O bonds are also found.

Group 18 of the periodic table consists of **noble gases**. They have ns^2np^6 valence shell electronic configuration except He which has $1s^2$. All the gases except Rn occur in atmosphere. Rn is obtained as the decay product of ^{226}Ra .

Due to complete octet of outermost shell, they have less tendency to form compounds. The best characterised compounds are those of xenon with fluorine and oxygen only under certain conditions. These gases have several uses. Argon is used to provide inert atmosphere, helium is used in filling balloons for meteorological observations, neon is used in discharge tubes and fluorescent bulbs.

Exercises

- 7.1 Discuss the general characteristics of Group 15 elements with reference to their electronic configuration, oxidation state, atomic size, ionisation enthalpy and electronegativity.
- 7.2 Why does the reactivity of nitrogen differ from phosphorus?
- 7.3 Discuss the trends in chemical reactivity of group 15 elements.
- 7.4 Why does NH_3 form hydrogen bond but PH_3 does not?
- 7.5 How is nitrogen prepared in the laboratory? Write the chemical equations of the reactions involved.
- 7.6 How is ammonia manufactured industrially?
- 7.7 Illustrate how copper metal can give different products on reaction with HNO_3 .
- 7.8 Give the resonating structures of NO_2 and N_2O_5 .
- 7.9 The HNH angle value is higher than HPH, HAsH and HSbH angles. Why? [Hint: Can be explained on the basis of sp^3 hybridisation in NH_3 and only s - p bonding between hydrogen and other elements of the group].
- 7.10 Why does $\text{R}_3\text{P} = \text{O}$ exist but $\text{R}_3\text{N} = \text{O}$ does not (R = alkyl group)?
- 7.11 Explain why NH_3 is basic while BiH_3 is only feebly basic.
- 7.12 Nitrogen exists as diatomic molecule and phosphorus as P_4 . Why?
- 7.13 Write main differences between the properties of white phosphorus and red phosphorus.
- 7.14 Why does nitrogen show catenation properties less than phosphorus?
- 7.15 Give the disproportionation reaction of H_3PO_3 .
- 7.16 Can PCl_5 act as an oxidising as well as a reducing agent? Justify.
- 7.17 Justify the placement of O, S, Se, Te and Po in the same group of the periodic table in terms of electronic configuration, oxidation state and hydride formation.
- 7.18 Why is dioxygen a gas but sulphur a solid?
- 7.19 Knowing the electron gain enthalpy values for $\text{O} \rightarrow \text{O}^-$ and $\text{O} \rightarrow \text{O}^{2-}$ as -141 and 702 kJ mol^{-1} respectively, how can you account for the formation of a large number of oxides having O^{2-} species and not O^- ? (Hint: Consider lattice energy factor in the formation of compounds).
- 7.20 Which aerosols deplete ozone?
- 7.21 Describe the manufacture of H_2SO_4 by contact process?
- 7.22 How is SO_2 an air pollutant?
- 7.23 Why are halogens strong oxidising agents?
- 7.24 Explain why fluorine forms only one oxoacid, HOF.
- 7.25 Explain why in spite of nearly the same electronegativity, oxygen forms hydrogen bonding while chlorine does not.
- 7.26 Write two uses of ClO_2 .
- 7.27 Why are halogens coloured?
- 7.28 Write the reactions of F_2 and Cl_2 with water.
- 7.29 How can you prepare Cl_2 from HCl and HCl from Cl_2 ? Write reactions only.
- 7.30 What inspired N. Bartlett for carrying out reaction between Xe and PtF_6 ?
- 7.31 What are the oxidation states of phosphorus in the following:
(i) H_3PO_3 (ii) PCl_3 (iii) Ca_3P_2 (iv) Na_3PO_4 (v) POF_3 ?

- 7.32** Write balanced equations for the following:
 (i) NaCl is heated with sulphuric acid in the presence of MnO₂.
 (ii) Chlorine gas is passed into a solution of NaI in water.
- 7.33** How are xenon fluorides XeF₂, XeF₄ and XeF₆ obtained?
- 7.34** With what neutral molecule is ClO⁻ isoelectronic? Is that molecule a Lewis base?
- 7.35** How are XeO₃ and XeOF₄ prepared?
- 7.36** Arrange the following in the order of property indicated for each set:
 (i) F₂, Cl₂, Br₂, I₂ - increasing bond dissociation enthalpy.
 (ii) HF, HCl, HBr, HI - increasing acid strength.
 (iii) NH₃, PH₃, AsH₃, SbH₃, BiH₃ - increasing base strength.
- 7.37** Which one of the following does not exist?
 (i) XeOF₄ (ii) NeF₂ (iii) XeF₂ (iv) XeF₆
- 7.38** Give the formula and describe the structure of a noble gas species which is isostructural with:
 (i) ICl₄⁻ (ii) IBr₂⁻ (iii) BrO₃⁻
- 7.39** Why do noble gases have comparatively large atomic sizes?
- 7.40** List the uses of neon and argon gases.

Answers to Some Intext Questions

- 7.1** Higher the positive oxidation state of central atom, more will be its polarising power which, in turn, increases the covalent character of bond formed between the central atom and the other atom.
- 7.2** Because BiH₃ is the least stable among the hydrides of Group 15.
- 7.3** Because of strong pπ-pπ overlap resulting into the triple bond, N≡N.
- 7.6** From the structure of N₂O₅ it is evident that covalence of nitrogen is four.
- 7.7** Both are sp³ hybridised. In PH₄⁺ all the four orbitals are bonded whereas in PH₃ there is a lone pair of electrons on P, which is responsible for lone pair-bond pair repulsion in PH₃ reducing the bond angle to less than 109° 28'.
- 7.10** PCl₅ + D₂O → POCl₃ + 2DCl
- 7.11** Three P-OH groups are present in the molecule of H₃PO₄. Therefore, its basicity is three.
- 7.15** Because of small size and high electronegativity of oxygen, molecules of water are highly associated through hydrogen bonding resulting in its liquid state.
- 7.21** Both the S-O bonds are covalent and have equal strength due to resonating structures.
- 7.25** H₂SO₄ is a very strong acid in water largely because of its first ionisation to H₃O⁺ and HSO₄⁻. The ionisation of HSO₄⁻ to H₃O⁺ and SO₄²⁻ is very very small. That is why K_{a2} << K_{a1}.
- 7.31** In general, interhalogen compounds are more reactive than halogens due to weaker X-X¹ bonding than X-X bond. Thus, ICl is more reactive than I₂.
- 7.34** Radon is radioactive with very short half-life which makes the study of chemistry of radon difficult.

Unit

8

The *d*- and *f*-Block Elements

Objectives

After studying this Unit, you will be able to

- learn the positions of the *d*- and *f*-block elements in the periodic table;
- know the electronic configurations of the transition (*d*-block) and the inner transition (*f*-block) elements;
- appreciate the relative stability of various oxidation states in terms of electrode potential values;
- describe the preparation, properties, structures and uses of some important compounds such as $\text{K}_2\text{Cr}_2\text{O}_7$ and KMnO_4 ;
- understand the general characteristics of the *d*- and *f*-block elements and the general horizontal and group trends in them;
- describe the properties of the *f*-block elements and give a comparative account of the lanthanoids and actinoids with respect to their electronic configurations, oxidation states and chemical behaviour.

Iron, copper, silver and gold are among the transition elements that have played important roles in the development of human civilisation. The inner transition elements such as Th, Pa and U are proving excellent sources of nuclear energy in modern times.

The *d*-block of the periodic table contains the elements of the groups 3-12 in which the *d* orbitals are progressively filled in each of the four long periods. The elements constituting the *f*-block are those in which the 4 *f* and 5 *f* orbitals are progressively filled in the latter two long periods; these elements are formal members of group 3 from which they have been taken out to form a separate *f*-block of the periodic table. The names *transition metals* and *inner transition metals* are often used to refer to the elements of *d*- and *f*-blocks respectively.

There are mainly three series of the transition metals, 3*d* series (Sc to Zn), 4*d* series (Y to Cd) and 5*d* series (La to Hg, omitting Ce to Lu). The fourth 6*d* series which begins with Ac is still incomplete. The two series of the inner transition metals, (4*f* and 5*f*) are known as *lanthanoids* and *actinoids* respectively.

Strictly speaking, a transition element is defined as the one which has incompletely filled *d* orbitals in its ground state or in any one of its oxidation states. Zinc, cadmium and mercury of group 12 have full d^{10} configuration in their ground state as well as in their common oxidation states and hence, are not regarded as transition metals. However, being the end members of the three transition series, their chemistry is studied along with the chemistry of the transition metals.

The presence of partly filled *d* or *f* orbitals in their atoms sets the study of the transition elements and

their compounds apart from that of the main group elements. However, the usual theory of valence as applicable to the main group elements can also be applied successfully to the transition elements.

Various precious metals such as silver, gold and platinum and industrially important metals like iron, copper and titanium form part of the transition metals.

In this Unit, besides introduction, we shall first deal with the electronic configuration, occurrence and general characteristics of the transition elements with special emphasis on the trends in the properties of the first row (3d) transition metals and the preparation and properties of some important compounds. This will be followed by consideration of certain general aspects such as electronic configurations, oxidation states and chemical reactivity of the inner transition metals.

THE TRANSITION ELEMENTS (d-BLOCK)

8.1 Position in the Periodic Table

The *d*-block occupies the large middle section flanked by *s*- and *p*- blocks in the periodic table. The very name 'transition' given to the elements of *d*-block is only because of their position between *s*- and *p*- block elements. The *d*-orbitals of the penultimate energy level in their atoms receive electrons giving rise to the three rows of the transition metals, i.e., 3*d*, 4*d* and 5*d*. The fourth row of 6*d* is still incomplete. These series of the transition elements are shown in Table 8.1.

8.2 Electronic Configurations of the *d*-Block Elements

In general the electronic configuration of these elements is $(n-1)d^{1-10}ns^{1-2}$. The $(n-1)$ stands for the inner *d* orbitals which may have one to ten electrons and the outermost *ns* orbital may have one or two electrons. However, this generalisation has several exceptions because of very little energy difference between $(n-1)d$ and *ns* orbitals. Furthermore, half and completely filled sets of orbitals are relatively more stable. A consequence of this factor is reflected in the electronic configurations of Cr and Cu in the 3*d* series. Consider the case of Cr, for example, which has $3d^5 4s^1$ instead of $3d^4 4s^2$; the energy gap between the two sets (3*d* and 4*s*) of orbitals is small enough to prevent electron entering the 3*d* orbitals. Similarly in case of Cu, the configuration is $3d^{10} 4s^1$ and not $3d^9 4s^2$. The outer electronic configurations of the transition elements are given in Table 8.1.

Table 8.1: Outer Electronic Configurations of the Transition Elements (ground state)

1st Series										
	Sc	Ti	V	Cr	Mn	Fe	Co	Ni	Cu	Zn
<i>Z</i>	21	22	23	24	25	26	27	28	29	30
4 <i>s</i>	2	2	2	1	2	2	2	2	1	2
3 <i>d</i>	1	2	3	5	5	6	7	8	10	10

2nd Series										
	Y	Zr	Nb	Mo	Tc	Ru	Rh	Pd	Ag	Cd
Z	39	40	41	42	43	44	45	46	47	48
5s	2	2	1	1	1	1	1	0	1	2
4d	1	2	4	5	6	7	8	10	10	10

3rd Series										
	La	Hf	Ta	W	Re	Os	Ir	Pt	Au	Hg
Z	57	72	73	74	75	76	77	78	79	80
6s	2	2	2	2	2	2	2	1	1	2
5d	1	2	3	4	5	6	7	9	10	10

4th Series										
	Ac	Rf	Db	Sg	Bh	Hs	Mt	Ds	Rg	Uub
Z	89	104	105	106	107	108	109	110	111	112
7s	2	2	2	2	2	2	2	2	1	2
6d	1	2	3	4	5	6	7	8	10	10

The electronic configurations of Zn, Cd and Hg are represented by the general formula $(n-1)d^{10}ns^2$. The orbitals in these elements are completely filled in the ground state as well as in their common oxidation states. Therefore, they are not regarded as transition elements.

The d orbitals of the transition elements project to the periphery of an atom more than the other orbitals (i.e., s and p), hence, they are more influenced by the surroundings as well as affecting the atoms or molecules surrounding them. In some respects, ions of a given d^n configuration ($n = 1 - 9$) have similar magnetic and electronic properties. With partly filled d orbitals these elements exhibit certain characteristic properties such as display of a variety of oxidation states, formation of coloured ions and entering into complex formation with a variety of ligands.

The transition metals and their compounds also exhibit catalytic property and paramagnetic behaviour. All these characteristics have been discussed in detail later in this Unit.

There are greater horizontal similarities in the properties of the transition elements in contrast to the main group elements. However, some group similarities also exist. We shall first study the general characteristics and their trends in the horizontal rows (particularly $3d$ row) and then consider some group similarities.

On what ground can you say that scandium ($Z = 21$) is a transition element but zinc ($Z = 30$) is not? *Example 8.1*

On the basis of incompletely filled $3d$ orbitals in case of scandium atom in its ground state ($3d^1$), it is regarded as a transition element. On the other hand, zinc atom has completely filled d orbitals ($3d^{10}$) in its ground state as well as in its oxidised state, hence it is not regarded as a transition element. *Solution*

Intext Question

8.1 Silver atom has completely filled d orbitals ($4d^{10}$) in its ground state. How can you say that it is a transition element?

8.3 General Properties of the Transition Elements (d -Block)

8.3.1 Physical Properties

Nearly all the transition elements display typical metallic properties such as high tensile strength, ductility malleability, high thermal and electrical conductivity and metallic lustre. With the exceptions of Zn, Cd, Hg and Mn, they have one or more typical metallic structures at normal temperatures.

Lattice Structures of Transition Metals

Sc	Ti	V	Cr	Mn	Fe	Co	Ni	Cu	Zn
hcp (bcc)	hcp (bcc)	bcc	bcc (bcc, ccp)	X (hcp)	bcc (hcp)	ccp	ccp	ccp	X (hcp)
Y	Zr	Nb	Mo	Tc	Ru	Rh	Pd	Ag	Cd
hcp (bcc)	hcp (bcc)	bcc	bcc	hcp	hcp	ccp	ccp	ccp	X (hcp)
La	Hf	Ta	W	Re	Os	Ir	Pt	Au	Hg
hcp (ccp,bcc)	hcp (bcc)	bcc	bcc	hcp	hcp	ccp	ccp	ccp	X

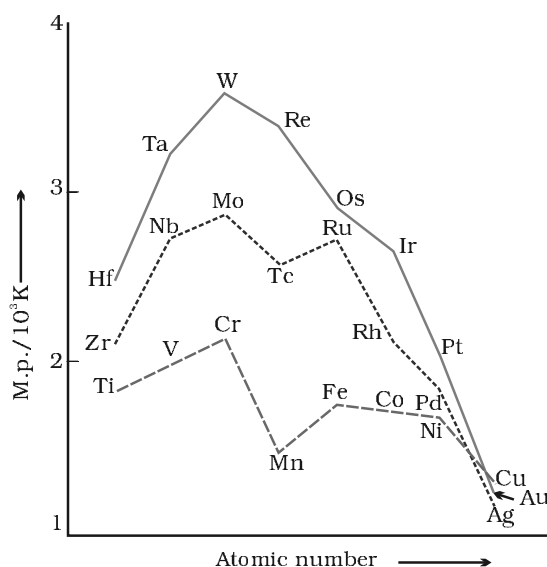

Fig. 8.1: Trends in melting points of transition elements

(bcc = body centred cubic; hcp = hexagonal close packed; ccp = cubic close packed; X = a typical metal structure).

The transition metals (with the exception of Zn, Cd and Hg) are very much hard and have low volatility. Their melting and boiling points are high. Fig. 8.1 depicts the melting points of the $3d$, $4d$ and $5d$ transition metals. The high melting points of these metals are attributed to the involvement of greater number of electrons from $(n-1)d$ in addition to the ns electrons in the interatomic metallic bonding. In any row the melting points of these metals rise to a maximum at d^5 except for anomalous values of Mn and Tc and fall regularly as the atomic number increases. They have high enthalpies of atomisation which are shown in Fig. 8.2. The maxima at about the middle of each series indicate that one unpaired electron per d orbital is particularly

favourable for strong interatomic interaction. In general, greater the number of valence electrons, stronger is the resultant bonding. Since the enthalpy of atomisation is an important factor in determining the standard electrode potential of a metal, metals with very high enthalpy of atomisation (i.e., very high boiling point) tend to be noble in their reactions (see later for electrode potentials).

Another generalisation that may be drawn from Fig. 8.2 is that the metals of the second and third series have greater enthalpies of atomisation than the corresponding elements of the first series; this is an important factor in accounting for the occurrence of much more frequent metal – metal bonding in compounds of the heavy transition metals.

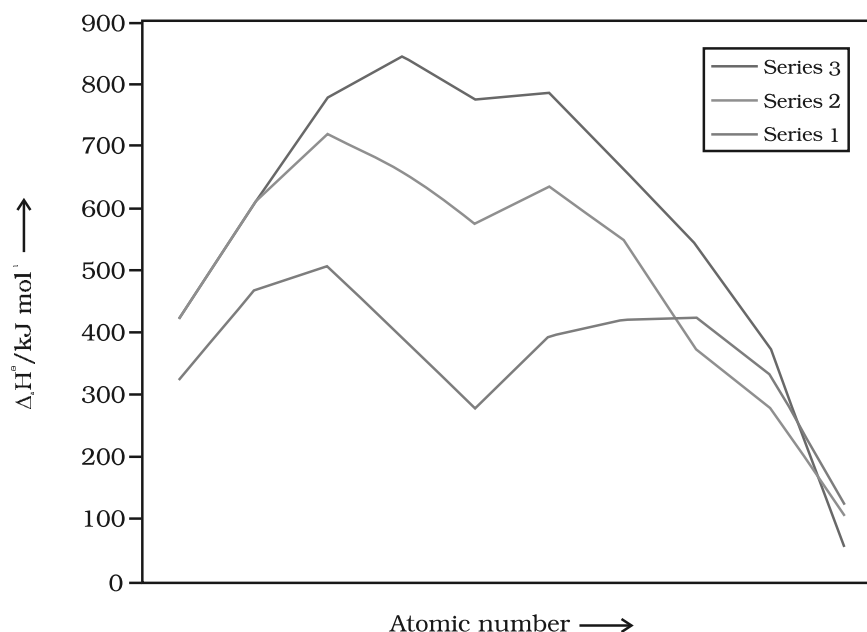

Fig. 8.2
Trends in enthalpies of atomisation of transition elements

8.3.2 Variation in Atomic and Ionic Sizes of Transition Metals

In general, ions of the same charge in a given series show progressive decrease in radius with increasing atomic number. This is because the new electron enters a d orbital each time the nuclear charge increases by unity. It may be recalled that the shielding effect of a d electron is not that effective, hence the net electrostatic attraction between the nuclear charge and the outermost electron increases and the ionic radius decreases. The same trend is observed in the atomic radii of a given series. However, the variation within a series is quite small. An interesting point emerges when atomic sizes of one series are compared with those of the corresponding elements in the other series. The curves in Fig. 8.3 show an increase from the first ($3d$) to the second ($4d$) series of the elements but the radii of the third ($5d$) series are virtually the same as those of the corresponding members of the second series. This phenomenon is associated with the intervention of the $4f$ orbitals which must be filled before the $5d$ series of elements begin. The filling of $4f$ before $5d$ orbital results in a regular decrease in atomic radii called **Lanthanoid contraction** which essentially compensates for the expected

increase in atomic size with increasing atomic number. The net result of the lanthanoid contraction is that the second and the third *d* series exhibit similar radii (e.g., Zr 160 pm, Hf 159 pm) and have very similar physical and chemical properties much more than that expected on the basis of usual family relationship.

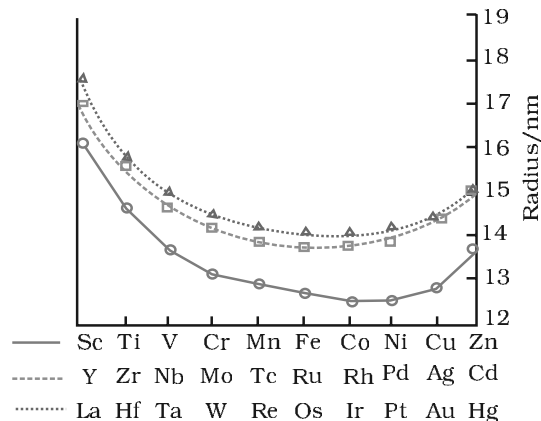

Fig. 8.3: Trends in atomic radii of transition elements

The factor responsible for the lanthanoid contraction is somewhat similar to that observed in an ordinary transition series and is attributed to similar cause, i.e., the imperfect shielding of one electron by another in the same set of orbitals. However, the shielding of one *4f* electron by another is less than that of one *d* electron by another, and as the nuclear charge increases along the series, there is fairly regular decrease in the size of the entire *4fⁿ* orbitals.

The decrease in metallic radius coupled with increase in atomic mass results in a general increase in the density of these elements. Thus, from titanium (*Z* = 22) to copper (*Z* = 29) the significant increase in the density may be noted (Table 8.2).

Table 8.2: Electronic Configurations and some other Properties of the First Series of Transition Elements

Element	Sc	Ti	V	Cr	Mn	Fe	Co	Ni	Cu	Zn	
Atomic number	21	22	23	24	25	26	27	28	29	30	
Electronic configuration											
M	$3d^1 4s^2$	$3d^2 4s^2$	$3d^3 4s^2$	$3d^5 4s^1$	$3d^5 4s^2$	$3d^6 4s^2$	$3d^7 4s^2$	$3d^8 4s^2$	$3d^{10} 4s^1$	$3d^{10} 4s^2$	
M^+	$3d^1 4s^1$	$3d^2 4s^1$	$3d^3 4s^1$	$3d^5$	$3d^5 4s^1$	$3d^6 4s^1$	$3d^7 4s^1$	$3d^8 4s^1$	$3d^{10}$	$3d^{10} 4s^1$	
M^{2+}	$3d^1$	$3d^2$	$3d^3$	$3d^4$	$3d^5$	$3d^6$	$3d^7$	$3d^8$	$3d^9$	$3d^{10}$	
M^{3+}	[Ar]	$3d^1$	$3d^2$	$3d^3$	$3d^4$	$3d^5$	$3d^6$	$3d^7$	-	-	
Enthalpy of atomisation, $\Delta_a H^\ominus / \text{kJ mol}^{-1}$	326	473	515	397	281	416	425	430	339	126	
Ionisation enthalpy/$\Delta_i H^\ominus / \text{kJ mol}^{-1}$											
$\Delta_1 H^\ominus$	I	631	656	650	653	717	762	758	736	745	906
$\Delta_2 H^\ominus$	II	1235	1309	1414	1592	1509	1561	1644	1752	1958	1734
$\Delta_3 H^\ominus$	III	2393	2657	2833	2990	3260	2962	3243	3402	3556	3829
Metallic/ionic radii/pm											
M	164	147	135	129	137	126	125	125	128	137	
M^{2+}	-	-	79	82	82	77	74	70	73	75	
M^{3+}	73	67	64	62	65	65	61	60	-	-	
Standard electrode potential E^\ominus / V											
M^{2+}/M	-	-1.63	-1.18	-0.90	-1.18	-0.44	-0.28	-0.25	+0.34	-0.76	
M^{3+}/M^{2+}	-	-0.37	-0.26	-0.41	+1.57	+0.77	+1.97	-	-	-	
Density/g cm^{-3}	3.43	4.1	6.07	7.19	7.21	7.8	8.7	8.9	8.9	7.1	

Why do the transition elements exhibit higher enthalpies of atomisation? *Example 8.2*

Because of large number of unpaired electrons in their atoms they have stronger interatomic interaction and hence stronger bonding between atoms resulting in higher enthalpies of atomisation. *Solution*

Intext Question

8.2 In the series Sc ($Z = 21$) to Zn ($Z = 30$), the enthalpy of atomisation of zinc is the lowest, i.e., 126 kJ mol^{-1} . Why?

8.3.3 Ionisation Enthalpies

Due to an increase in nuclear charge which accompanies the filling of the inner d orbitals, there is an increase in ionisation enthalpy along each series of the transition elements from left to right. However, many small variations occur. Table 8.2 gives the values for the first three ionisation enthalpies of the first row elements. These values show that the successive enthalpies of these elements do not increase as steeply as in the main group elements. Although the first ionisation enthalpy, in general, increases, the magnitude of the increase in the second and third ionisation enthalpies for the successive elements, in general, is much higher.

The irregular trend in the first ionisation enthalpy of the $3d$ metals, though of little chemical significance, can be accounted for by considering that the removal of one electron alters the relative energies of $4s$ and $3d$ orbitals. So the unipositive ions have d^n configurations with no $4s$ electrons. There is thus, a reorganisation energy accompanying ionisation with some gains in exchange energy as the number of electrons increases and from the transference of s electrons into d orbitals. There is the generally expected increasing trend in the values as the effective nuclear charge increases. However, the value of Cr is lower because of the absence of any change in the d configuration and the value for Zn higher because it represents an ionisation from the $4s$ level. The lowest common oxidation state of these metals is $+2$. To form the M^{2+} ions from the gaseous atoms, the sum of the first and second ionisation energies is required in addition to the enthalpy of atomisation for each element. The dominant term is the second ionisation enthalpy which shows unusually high values for Cr and Cu where the d^5 and d^{10} configurations of the M^+ ions are disrupted, with considerable loss of exchange energy. The value for Zn is correspondingly low as the ionisation consists of the removal of an electron which allows the production of the stable d^{10} configuration. The trend in the third ionisation enthalpies is not complicated by the $4s$ orbital factor and shows the greater difficulty of removing an electron from the d^5 (Mn^{2+}) and d^{10} (Zn^{2+}) ions superimposed upon the general increasing trend. In general, the third ionisation enthalpies are quite high and there is a marked break between the values for Mn^{2+} and Fe^{2+} . Also the high values for

copper, nickel and zinc indicate why it is difficult to obtain oxidation state greater than two for these elements.

Although ionisation enthalpies give some guidance concerning the relative stabilities of oxidation states, this problem is very complex and not amendable to ready generalisation.

8.3.4 Oxidation States

One of the notable features of a transition element is the great variety of oxidation states it may show in its compounds. Table 8.3 lists the common oxidation states of the first row transition elements.

Table 8.3: Oxidation States of the first row Transition Metals (the most common ones are in bold types)

Sc	Ti	V	Cr	Mn	Fe	Co	Ni	Cu	Zn
	+2	+2	+2	+2	+2	+2	+2	+1	+2
+3	+3	+3	+3	+3	+3	+3	+3	+2	
	+4	+4	+4	+4	+4	+4	+4		
		+5	+5	+5					
			+6	+6	+6				
				+7					

The elements which give the greatest number of oxidation states occur in or near the middle of the series. Manganese, for example, exhibits all the oxidation states from +2 to +7. The lesser number of oxidation states at the extreme ends stems from either too few electrons to lose or share (Sc, Ti) or too many *d* electrons (hence fewer orbitals available in which to share electrons with others) for higher valence (Cu, Zn). Thus, early in the series scandium(II) is virtually unknown and titanium (IV) is more stable than Ti(III) or Ti(II). At the other end, the only oxidation state of zinc is +2 (no *d* electrons are involved). The maximum oxidation states of reasonable stability correspond in value to the sum of the *s* and *d* electrons upto manganese ($\text{Ti}^{\text{IV}}\text{O}_2$, $\text{V}^{\text{V}}\text{O}_2^+$, $\text{Cr}^{\text{VI}}\text{O}_4^{2-}$, $\text{Mn}^{\text{VII}}\text{O}_4^-$) followed by a rather abrupt decrease in stability of higher oxidation states, so that the typical species to follow are $\text{Fe}^{\text{II,III}}$, $\text{Co}^{\text{II,III}}$, Ni^{II} , $\text{Cu}^{\text{I,II}}$, Zn^{II} .

The variability of oxidation states, a characteristic of transition elements, arises out of incomplete filling of *d* orbitals in such a way that their oxidation states differ from each other by unity, e.g., V^{II} , V^{III} , V^{IV} , V^{V} . This is in contrast with the variability of oxidation states of non transition elements where oxidation states normally differ by a unit of two.

An interesting feature in the variability of oxidation states of the *d*-block elements is noticed among the groups (groups 4 through 10). Although in the *p*-block the lower oxidation states are favoured by the heavier members (due to inert pair effect), the opposite is true in the groups of *d*-block. For example, in group 6, Mo(VI) and W(VI) are found to be more stable than Cr(VI). Thus Cr(VI) in the form of dichromate in acidic medium is a strong oxidising agent, whereas MoO_3 and WO_3 are not.

Low oxidation states are found when a complex compound has ligands capable of π -acceptor character in addition to the σ -bonding. For example, in $\text{Ni}(\text{CO})_4$ and $\text{Fe}(\text{CO})_5$, the oxidation state of nickel and iron is zero.

Name a transition element which does not exhibit variable oxidation states. *Example 8.3*

Scandium ($Z = 21$) does not exhibit variable oxidation states.

Solution

Intext Question

8.3.5 Trends in the M^{2+}/M Standard Electrode Potentials

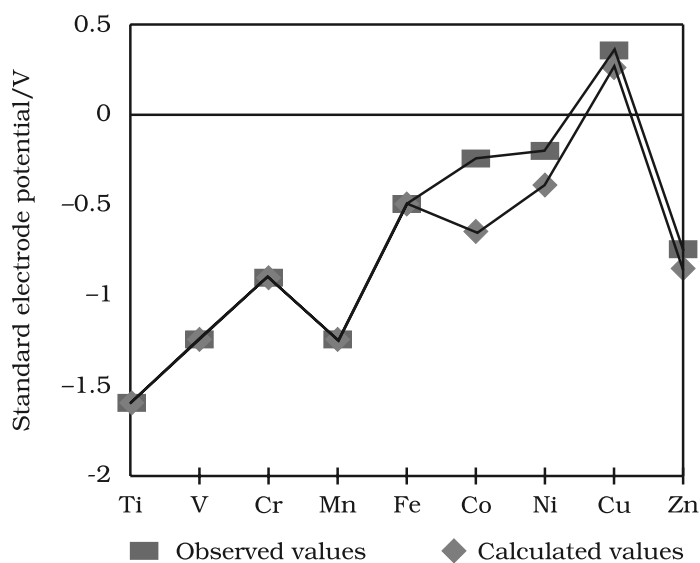

Fig. 8.4: Observed and calculated values for the standard electrode potentials ($M^{2+} \rightarrow M$) of the elements Ti to Zn

Table 8.4 contains the thermochemical parameters related to the transformation of the solid metal atoms to M^{2+} ions in solution and their standard electrode potentials. The observed values of E^\ominus and those calculated using the data of Table 8.4 are compared in Fig. 8.4.

The unique behaviour of Cu, having a positive E^\ominus , accounts for its inability to liberate H_2 from acids. Only oxidising acids (nitric and hot concentrated sulphuric) react with Cu, the acids being reduced. The high energy to transform $Cu(s)$ to $Cu^{2+}(aq)$ is not balanced by its hydration enthalpy. The general trend towards less negative E^\ominus values across the series is related to the general increase in the sum of the first and second ionisation enthalpies. It is interesting to note that the value of E^\ominus for Mn, Ni and Zn are more negative than expected from the trend.

Why is Cr^{2+} reducing and Mn^{3+} oxidising when both have d^4 configuration. *Example 8.4*

Cr^{2+} is reducing as its configuration changes from d^4 to d^3 , the latter having a half-filled t_{2g} level (see Unit 9). On the other hand, the change from Mn^{2+} to Mn^{3+} results in the half-filled (d^5) configuration which has extra stability.

Solution

Intext Question

8.4 The $E^\ominus(M^{2+}/M)$ value for copper is positive (+0.34V). What is possibly the reason for this? (Hint: consider its high $\Delta_a H^\ominus$ and low $\Delta_{hyd} H^\ominus$)

Table 8.4: Thermochemical data (kJ mol^{-1}) for the first row Transition Elements and the Standard Electrode Potentials for the Reduction of M^{II} to M.

Element (M)	$\Delta_a H^\ominus$ (M)	$\Delta_1 H_1^\ominus$	$\Delta_1 H_2^\ominus$	$\Delta_{\text{hyd}} H^\ominus(\text{M}^{2+})$	E^\ominus / V
Ti	469	661	1310	-1866	-1.63
V	515	648	1370	-1895	-1.18
Cr	398	653	1590	-1925	-0.90
Mn	279	716	1510	-1862	-1.18
Fe	418	762	1560	-1998	-0.44
Co	427	757	1640	-2079	-0.28
Ni	431	736	1750	-2121	-0.25
Cu	339	745	1960	-2121	0.34
Zn	130	908	1730	-2059	-0.76

The stability of the half-filled d sub-shell in Mn^{2+} and the completely filled d^{10} configuration in Zn^{2+} are related to their E^\ominus values, whereas E^\ominus for Ni is related to the highest negative $\Delta_{\text{hyd}} H^\ominus$.

8.3.6 Trends in the $\text{M}^{3+}/\text{M}^{2+}$ Standard Electrode Potentials

An examination of the $E^\ominus(\text{M}^{3+}/\text{M}^{2+})$ values (Table 8.2) shows the varying trends. The low value for Sc reflects the stability of Sc^{3+} which has a noble gas configuration. The highest value for Zn is due to the removal of an electron from the stable d^{10} configuration of Zn^{2+} . The comparatively high value for Mn shows that $\text{Mn}^{2+}(d^5)$ is particularly stable, whereas comparatively low value for Fe shows the extra stability of $\text{Fe}^{3+}(d^5)$. The comparatively low value for V is related to the stability of V^{2+} (half-filled t_{2g} level, Unit 9).

8.3.7 Trends in Stability of Higher Oxidation States

Table 8.5 shows the stable halides of the $3d$ series of transition metals. The highest oxidation numbers are achieved in TiX_4 (tetrahalides), VF_5 and CrF_6 . The +7 state for Mn is not represented in simple halides but MnO_3F is known, and beyond Mn no metal has a trihalide except FeX_3 and CoF_3 . The ability of fluorine to stabilise the highest oxidation state is due to either higher lattice energy as in the case of CoF_3 , or higher bond enthalpy terms for the higher covalent compounds, e.g., VF_5 and CrF_6 .

Although V^{V} is represented only by VF_5 , the other halides, however, undergo hydrolysis to give oxohalides, VOX_3 . Another feature of fluorides is their instability in the low oxidation states e.g., VX_2 ($\text{X} = \text{Cl}, \text{Br}$ or I)

Table 8.5: Formulas of Halides of 3d Metals

Oxidation Number									
+ 6			CrF_6						
+ 5		VF_5	CrF_5						
+ 4	TiX_4	VX_4^{I}	CrX_4	MnF_4					
+ 3	TiX_3	VX_3	CrX_3	MnF_3	FeX_3^{I}	CoF_3			
+ 2	$\text{TiX}_2^{\text{III}}$	VX_2	CrX_2	MnX_2	FeX_2	CoX_2	NiX_2	CuX_2^{II}	ZnX_2
+ 1								CuX^{III}	

Key: $\text{X} = \text{F} \rightarrow \text{I}$; $\text{X}^{\text{I}} = \text{F} \rightarrow \text{Br}$; $\text{X}^{\text{II}} = \text{F}, \text{Cl}$; $\text{X}^{\text{III}} = \text{Cl} \rightarrow \text{I}$

and the same applies to CuX. On the other hand, all Cu^{II} halides are known except the iodide. In this case, Cu²⁺ oxidises I⁻ to I₂:

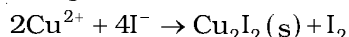

However, many copper (I) compounds are unstable in aqueous solution and undergo disproportionation.

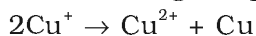

The stability of Cu²⁺ (aq) rather than Cu⁺(aq) is due to the much more negative $\Delta_{\text{hyd}}H^{\ominus}$ of Cu²⁺ (aq) than Cu⁺, which more than compensates for the second ionisation enthalpy of Cu.

The ability of oxygen to stabilise the highest oxidation state is demonstrated in the oxides. The highest oxidation number in the oxides (Table 8.6) coincides with the group number and is attained in Sc₂O₃ to Mn₂O₇. Beyond Group 7, no higher oxides of Fe above Fe₂O₃, are known, although ferrates (VI)(FeO₄)²⁻, are formed in alkaline media but they readily decompose to Fe₂O₃ and O₂. Besides the oxides, oxocations stabilise V^V as VO₂⁺, V^{IV} as VO²⁺ and Ti^{IV} as TiO²⁺. The ability of oxygen to stabilise these high oxidation states exceeds that of fluorine. Thus the highest Mn fluoride is MnF₄ whereas the highest oxide is Mn₂O₇. The ability of oxygen to form multiple bonds to metals explains its superiority. In the covalent oxide Mn₂O₇, each Mn is tetrahedrally surrounded by O's including a Mn–O–Mn bridge. The tetrahedral [MO₄]ⁿ⁻ ions are known for V^V, Cr^{VI}, Mn^V, Mn^{VI} and Mn^{VII}.

Table 8.6: Oxides of 3d Metals

Oxidation Number	Groups										
	3	4	5	6	7	8	9	10	11	12	
+ 7											Mn ₂ O ₇
+ 6					CrO ₃						
+ 5			V ₂ O ₅								
+ 4		TiO ₂	V ₂ O ₄	CrO ₂	MnO ₂						
+ 3	Sc ₂ O ₃	Ti ₂ O ₃	V ₂ O ₃	Cr ₂ O ₃	Mn ₂ O ₃	Fe ₂ O ₃					
					Mn ₃ O ₄ *	Fe ₃ O ₄ *	Co ₃ O ₄ *				
+ 2		TiO	VO	(CrO)	MnO	FeO	CoO	NiO	CuO	ZnO	
+ 1									Cu ₂ O		

* mixed oxides

How would you account for the increasing oxidising power in the *Example 8.5* series VO₂⁺ < Cr₂O₇²⁻ < MnO₄⁻?

This is due to the increasing stability of the lower species to which they *Solution* are reduced.

Intext Question

8.5 How would you account for the irregular variation of ionisation enthalpies (first and second) in the first series of the transition elements?

8.3.8 Chemical Reactivity and E^\ominus Values

Transition metals vary widely in their chemical reactivity. Many of them are sufficiently electropositive to dissolve in mineral acids, although a few are 'noble'—that is, they are unaffected by simple acids.

The metals of the first series with the exception of copper are relatively more reactive and are oxidised by 1M H^+ , though the actual rate at which these metals react with oxidising agents like hydrogen ion (H^+) is sometimes slow. For example, titanium and vanadium, in practice, are passive to dilute non oxidising acids at room temperature. The E^\ominus values for M^{2+}/M (Table 8.2) indicate a decreasing tendency to form divalent cations across the series. This general trend towards less negative E^\ominus values is related to the increase in the sum of the first and second ionisation enthalpies. It is interesting to note that the E^\ominus values for Mn, Ni and Zn are more negative than expected from the general trend. Whereas the stabilities of half-filled d subshell (d^5) in Mn^{2+} and completely filled d subshell (d^{10}) in zinc are related to their E^\ominus values; for nickel, E^\ominus value is related to the highest negative enthalpy of hydration.

An examination of the E^\ominus values for the redox couple M^{3+}/M^{2+} (Table 8.2) shows that Mn^{3+} and Co^{3+} ions are the strongest oxidising agents in aqueous solutions. The ions Ti^{2+} , V^{2+} and Cr^{2+} are strong reducing agents and will liberate hydrogen from a dilute acid, e.g.,

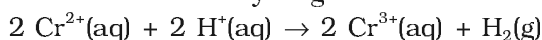

Example 8.6

For the first row transition metals the E^\ominus values are:

E^\ominus (M^{2+}/M)	V	Cr	Mn	Fe	Co	Ni	Cu
	-1.18	-0.91	-1.18	-0.44	-0.28	-0.25	+0.34

Explain the irregularity in the above values.

Solution

The E^\ominus (M^{2+}/M) values are not regular which can be explained from the irregular variation of ionisation enthalpies ($\Delta_1H_1 + \Delta_1H_2$) and also the sublimation enthalpies which are relatively much less for manganese and vanadium.

Example 8.7

Why is the E^\ominus value for the Mn^{3+}/Mn^{2+} couple much more positive than that for Cr^{3+}/Cr^{2+} or Fe^{3+}/Fe^{2+} ? Explain.

Solution

Much larger third ionisation energy of Mn (where the required change is d^5 to d^4) is mainly responsible for this. This also explains why the +3 state of Mn is of little importance.

Intext Questions

- 8.6 Why is the highest oxidation state of a metal exhibited in its oxide or fluoride only?
- 8.7 Which is a stronger reducing agent Cr^{2+} or Fe^{2+} and why ?

8.3.9 Magnetic Properties

When a magnetic field is applied to substances, mainly two types of magnetic behaviour are observed: *diamagnetism* and *paramagnetism* (Unit 1). Diamagnetic substances are repelled by the applied field while the paramagnetic substances are attracted. Substances which are

attracted very strongly are said to be *ferromagnetic*. In fact, ferromagnetism is an extreme form of paramagnetism. Many of the transition metal ions are paramagnetic.

Paramagnetism arises from the presence of unpaired electrons, each such electron having a magnetic moment associated with its spin angular momentum and orbital angular momentum. For the compounds of the first series of transition metals, the contribution of the orbital angular momentum is effectively quenched and hence is of no significance. For these, the magnetic moment is determined by the number of unpaired electrons and is calculated by using the 'spin-only' formula, i.e.,

$$\mu = \sqrt{n(n+2)}$$

where n is the number of unpaired electrons and μ is the magnetic moment in units of Bohr magneton (BM). A single unpaired electron has a magnetic moment of 1.73 Bohr magnetons (BM).

The magnetic moment increases with the increasing number of unpaired electrons. Thus, the observed magnetic moment gives a useful indication about the number of unpaired electrons present in the atom, molecule or ion. The magnetic moments calculated from the 'spin-only' formula and those derived experimentally for some ions of the first row transition elements are given in Table 8.7. The experimental data are mainly for hydrated ions in solution or in the solid state.

Table 8.7: Calculated and Observed Magnetic Moments (BM)

Ion	Configuration	Unpaired electron(s)	Magnetic moment	
			Calculated	Observed
Sc ³⁺	3d ⁰	0	0	0
Ti ³⁺	3d ¹	1	1.73	1.75
Ti ²⁺	3d ²	2	2.84	2.76
V ²⁺	3d ³	3	3.87	3.86
Cr ²⁺	3d ⁴	4	4.90	4.80
Mn ²⁺	3d ⁵	5	5.92	5.96
Fe ²⁺	3d ⁶	4	4.90	5.3 – 5.5
Co ²⁺	3d ⁷	3	3.87	4.4 – 5.2
Ni ²⁺	3d ⁸	2	2.84	2.9 – 3, 4
Cu ²⁺	3d ⁹	1	1.73	1.8 – 2.2
Zn ²⁺	3d ¹⁰	0	0	

Calculate the magnetic moment of a divalent ion in aqueous solution if its atomic number is 25.

Example 8.8

With atomic number 25, the divalent ion in aqueous solution will have d⁵ configuration (five unpaired electrons). The magnetic moment, μ is

Solution

$$\mu = \sqrt{5(5+2)} = 5.92 \text{ BM}$$

Intext Question

8.8 Calculate the 'spin only' magnetic moment of $M^{2+}_{(aq)}$ ion ($Z = 27$).

8.3.10 Formation of Coloured Ions

When an electron from a lower energy d orbital is excited to a higher energy d orbital, the energy of excitation corresponds to the frequency of light absorbed (Unit 9). This frequency generally lies in the visible region. The colour observed corresponds to the complementary colour of the light absorbed. The frequency of the light absorbed is determined by the nature of the ligand. In aqueous solutions where water molecules are the ligands, the colours of the ions observed are listed in Table 8.8. A few coloured solutions of d -block elements are illustrated in Fig. 8.5.



Fig. 8.5: Colours of some of the first row transition metal ions in aqueous solutions. From left to right: V^{2+} , V^{3+} , Mn^{2+} , Fe^{3+} , Co^{2+} , Ni^{2+} and Cu^{2+} .

Table 8.8: Colours of Some of the First Row (aquated) Transition Metal Ions

Configuration	Example	Colour
$3d^0$	Sc^{3+}	colourless
$3d^0$	Ti^{4+}	colourless
$3d^1$	Ti^{3+}	purple
$3d^1$	V^{4+}	blue
$3d^2$	V^{3+}	green
$3d^3$	V^{2+}	violet
$3d^3$	Cr^{3+}	violet
$3d^4$	Mn^{3+}	violet
$3d^4$	Cr^{2+}	blue
$3d^5$	Mn^{2+}	pink
$3d^5$	Fe^{3+}	yellow
$3d^6$	Fe^{2+}	green
$3d^6 3d^7$	$Co^{3+} Co^{2+}$	bluepink
$3d^8$	Ni^{2+}	green
$3d^9$	Cu^{2+}	blue
$3d^{10}$	Zn^{2+}	colourless

8.3.11 Formation of Complex Compounds

Complex compounds are those in which the metal ions bind a number of anions or neutral molecules giving complex species with characteristic properties. A few examples are: $[Fe(CN)_6]^{3-}$, $[Fe(CN)_6]^{4-}$, $[Cu(NH_3)_4]^{2+}$ and $[PtCl_4]^{2-}$. (The chemistry of complex compounds is

dealt with in detail in Unit 9). The transition metals form a large number of complex compounds. This is due to the comparatively smaller sizes of the metal ions, their high ionic charges and the availability of *d* orbitals for bond formation.

8.3.12 Catalytic Properties

The transition metals and their compounds are known for their catalytic activity. This activity is ascribed to their ability to adopt multiple oxidation states and to form complexes. Vanadium(V) oxide (in Contact Process), finely divided iron (in Haber's Process), and nickel (in Catalytic Hydrogenation) are some of the examples. Catalysts at a solid surface involve the formation of bonds between reactant molecules and atoms of the surface of the catalyst (first row transition metals utilise 3*d* and 4*s* electrons for bonding). This has the effect of increasing the concentration of the reactants at the catalyst surface and also weakening of the bonds in the reacting molecules (the activation energy is lowering). Also because the transition metal ions can change their oxidation states, they become more effective as catalysts. For example, iron(III) catalyses the reaction between iodide and persulphate ions.

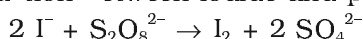

An explanation of this catalytic action can be given as:

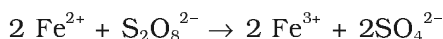
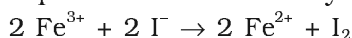

8.3.13 Formation of Interstitial Compounds

Interstitial compounds are those which are formed when small atoms like H, C or N are trapped inside the crystal lattices of metals. They are usually non stoichiometric and are neither typically ionic nor covalent, for example, TiC, Mn₄N, Fe₃H, VH_{0.56} and TiH_{1.7}, etc. The formulas quoted do not, of course, correspond to any normal oxidation state of the metal. Because of the nature of their composition, these compounds are referred to as *interstitial* compounds. The principal physical and chemical characteristics of these compounds are as follows:

- (i) They have high melting points, higher than those of pure metals.
- (ii) They are very hard, some borides approach diamond in hardness.
- (iii) They retain metallic conductivity.
- (iv) They are chemically inert.

8.3.14 Alloy Formation

An alloy is a blend of metals prepared by mixing the components. Alloys may be homogeneous solid solutions in which the atoms of one metal are distributed randomly among the atoms of the other. Such alloys are formed by atoms with metallic radii that are within about 15 percent of each other. Because of similar radii and other characteristics of transition metals, alloys are readily formed by these metals. The alloys so formed are hard and have often high melting points. The best known are ferrous alloys: chromium, vanadium, tungsten, molybdenum and manganese are used for the production of a variety of steels and stainless steel. Alloys of transition metals with non transition metals such as brass (copper-zinc) and bronze (copper-tin), are also of considerable industrial importance.

Example 8.9 What is meant by 'disproportionation' of an oxidation state? Give an example.

Solution When a particular oxidation state becomes less stable relative to other oxidation states, one lower, one higher, it is said to undergo disproportionation. For example, manganese (VI) becomes unstable relative to manganese(VII) and manganese (IV) in acidic solution.



Intext Question

8.9 Explain why Cu^+ ion is not stable in aqueous solutions?

8.4 Some Important Compounds of Transition Elements

8.4.1 Oxides and Oxoanions of Metals

These oxides are generally formed by the reaction of metals with oxygen at high temperatures. All the metals except scandium form MO oxides which are ionic. The highest oxidation number in the oxides, coincides with the group number and is attained in Sc_2O_3 to Mn_2O_7 . Beyond group 7, no higher oxides of iron above Fe_2O_3 are known. Besides the oxides, the oxocations stabilise V^{V} as VO_2^+ , V^{IV} as VO^{2+} and Ti^{IV} as TiO^{2+} .

As the oxidation number of a metal increases, ionic character decreases. In the case of Mn, Mn_2O_7 is a covalent green oil. Even CrO_3 and V_2O_5 have low melting points. In these higher oxides, the acidic character is predominant.

Thus, Mn_2O_7 gives HMnO_4 and CrO_3 gives H_2CrO_4 and $\text{H}_2\text{Cr}_2\text{O}_7$. V_2O_5 is, however, amphoteric though mainly acidic and it gives VO_4^{3-} as well as VO_2^+ salts. In vanadium there is gradual change from the basic V_2O_3 to less basic V_2O_4 and to amphoteric V_2O_5 . V_2O_4 dissolves in acids to give VO^{2+} salts. Similarly, V_2O_5 reacts with alkalis as well as acids to give VO_4^{3-} and VO_4^+ respectively. The well characterised CrO is basic but Cr_2O_3 is amphoteric.

Potassium dichromate $\text{K}_2\text{Cr}_2\text{O}_7$

Potassium dichromate is a very important chemical used in leather industry and as an oxidant for preparation of many azo compounds. Dichromates are generally prepared from chromate, which in turn are obtained by the fusion of chromite ore (FeCr_2O_4) with sodium or potassium carbonate in free access of air. The reaction with sodium carbonate occurs as follows:

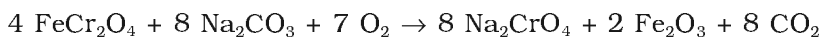

The yellow solution of sodium chromate is filtered and acidified with sulphuric acid to give a solution from which orange sodium dichromate, $\text{Na}_2\text{Cr}_2\text{O}_7 \cdot 2\text{H}_2\text{O}$ can be crystallised.



In the laboratory, a manganese (II) ion salt is oxidised by peroxodisulphate to permanganate.

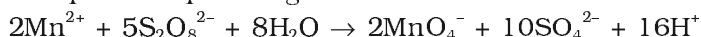

Potassium permanganate forms dark purple (almost black) crystals which are isostructural with those of KClO_4 . The salt is not very soluble in water (6.4 g/100 g of water at 293 K), but when heated it decomposes at 513 K.

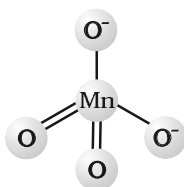
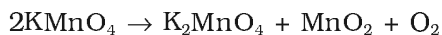

Tetrahedral
manganate
(green) ion

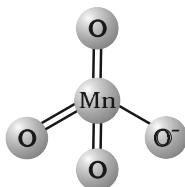

Tetrahedral
permanganate
(purple) ion

It has two physical properties of considerable interest: its intense colour and its weak temperature dependent paramagnetism. These can be explained by the use of molecular orbital theory which is beyond the present scope.

The manganate and permanganate ions are tetrahedral; the green manganate is paramagnetic with one unpaired electron but the permanganate is diamagnetic.

The π -bonding takes place by overlap of p orbitals of oxygen with d orbitals of manganese.

Acidified permanganate solution oxidises oxalates to carbon dioxide, iron(II) to iron(III), nitrites to nitrates and iodides to free iodine. The half-reactions of reductants are:

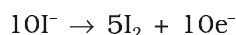
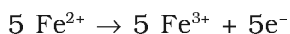
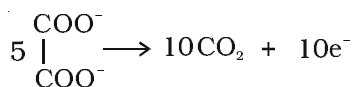

The full reaction can be written by adding the half-reaction for KMnO_4 to the half-reaction of the reducing agent, balancing wherever necessary.

If we represent the reduction of permanganate to manganate, manganese dioxide and manganese(II) salt by half-reactions,

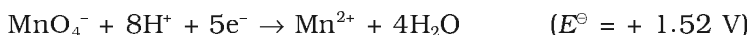
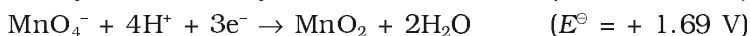

We can very well see that the hydrogen ion concentration of the solution plays an important part in influencing the reaction. Although many reactions can be understood by consideration of redox potential, kinetics of the reaction is also an important factor. Permanganate at $[\text{H}^+] = 1$ should oxidise water but in practice the reaction is extremely slow unless either manganese(II) ions are present or the temperature is raised.

A few important oxidising reactions of KMnO_4 are given below:

1. In acid solutions:

(a) Iodine is liberated from potassium iodide :



(b) Fe^{2+} ion (green) is converted to Fe^{3+} (yellow):

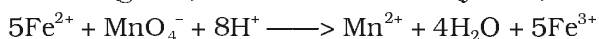

(c) Oxalate ion or oxalic acid is oxidised at 333 K:
$$5\text{C}_2\text{O}_4^{2-} + 2\text{MnO}_4^- + 16\text{H}^+ \longrightarrow 2\text{Mn}^{2+} + 8\text{H}_2\text{O} + 10\text{CO}_2$$

(d) Hydrogen sulphide is oxidised, sulphur being precipitated:
$$\text{H}_2\text{S} \longrightarrow 2\text{H}^+ + \text{S}^{2-}$$
$$5\text{S}^{2-} + 2\text{MnO}_4^- + 16\text{H}^+ \longrightarrow 2\text{Mn}^{2+} + 8\text{H}_2\text{O} + 5\text{S}$$

(e) Sulphurous acid or sulphite is oxidised to a sulphate or sulphuric acid:
$$5\text{SO}_3^{2-} + 2\text{MnO}_4^- + 6\text{H}^+ \longrightarrow 2\text{Mn}^{2+} + 3\text{H}_2\text{O} + 5\text{SO}_4^{2-}$$

(f) Nitrite is oxidised to nitrate:
$$5\text{NO}_2^- + 2\text{MnO}_4^- + 6\text{H}^+ \longrightarrow 2\text{Mn}^{2+} + 5\text{NO}_3^- + 3\text{H}_2\text{O}$$

2. In neutral or faintly alkaline solutions:

(a) A notable reaction is the oxidation of iodide to iodate:
$$2\text{MnO}_4^- + \text{H}_2\text{O} + \text{I}^- \longrightarrow 2\text{MnO}_2 + 2\text{OH}^- + \text{IO}_3^-$$

(b) Thiosulphate is oxidised almost quantitatively to sulphate:
$$8\text{MnO}_4^- + 3\text{S}_2\text{O}_3^{2-} + \text{H}_2\text{O} \longrightarrow 8\text{MnO}_2 + 6\text{SO}_4^{2-} + 2\text{OH}^-$$

(c) Manganous salt is oxidised to MnO_2 ; the presence of zinc sulphate or zinc oxide catalyses the oxidation:
$$2\text{MnO}_4^- + 3\text{Mn}^{2+} + 2\text{H}_2\text{O} \longrightarrow 5\text{MnO}_2 + 4\text{H}^+$$

Note: Permanganate titrations in presence of hydrochloric acid are unsatisfactory since hydrochloric acid is oxidised to chlorine.

Uses: Besides its use in analytical chemistry, potassium permanganate is used as a favourite oxidant in preparative organic chemistry. Its uses for the bleaching of wool, cotton, silk and other textile fibres and for the decolourisation of oils are also dependent on its strong oxidising power.

THE INNER TRANSITION ELEMENTS (*f*-BLOCK)

The *f*-block consists of the two series, lanthanoids (the fourteen elements following lanthanum) and actinoids (the fourteen elements following actinium). Because lanthanum closely resembles the lanthanoids, it is usually included in any discussion of the lanthanoids for which the general symbol Ln is often used. Similarly, a discussion of the actinoids includes actinium besides the fourteen elements constituting the series. The lanthanoids resemble one another more closely than do the members of ordinary transition elements in any series. They have only one stable oxidation state and their chemistry provides an excellent opportunity to examine the effect of small changes in size and nuclear charge along a series of otherwise similar elements. The chemistry of the actinoids is, on the other hand, much more complicated. The complication arises partly owing to the occurrence of a wide range of oxidation states in these elements and partly because their radioactivity creates special problems in their study; the two series will be considered separately here.

8.5 The Lanthanoids

The names, symbols, electronic configurations of atomic and some ionic states and atomic and ionic radii of lanthanum and lanthanoids (for which the general symbol Ln is used) are given in Table 8.9.

8.5.1 Electronic Configurations

It may be noted that atoms of these elements have electronic configuration with $6s^2$ common but with variable occupancy of $4f$ level (Table 8.9). However, the electronic configurations of all the tripositive ions (the most stable oxidation state of all the lanthanoids) are of the form $4f^n$ ($n = 1$ to 14 with increasing atomic number).

8.5.2 Atomic and Ionic Sizes

The overall decrease in atomic and ionic radii from lanthanum to lutetium (the **lanthanoid contraction**) is a unique feature in the chemistry of the lanthanoids. It has far reaching consequences in the chemistry of the third transition series of the elements. The decrease in atomic radii (derived from the structures of metals) is not quite regular as it is regular in M^{3+} ions (Fig. 8.6). This contraction is, of course, similar to that observed in an ordinary transition series and is attributed to the same cause, the imperfect shielding of one electron by another in the same sub-shell. However, the shielding of one $4f$ electron by another is less than one d electron by another with the increase in nuclear charge along the series. There is fairly regular decrease in the sizes with increasing atomic number.

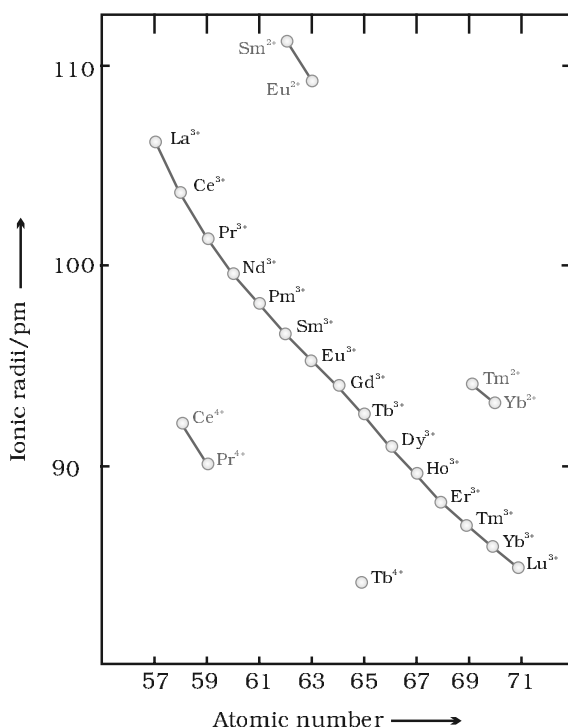

Fig. 8.6: Trends in ionic radii of lanthanoids

8.5.3 Oxidation States

In the lanthanoids, La(III) and Ln(III) compounds are predominant species. However, occasionally +2 and +4 ions in solution or in solid compounds are also obtained. This irregularity (as in ionisation enthalpies) arises mainly from the extra stability of empty, half-filled or filled f subshell. Thus, the formation of Ce^{IV} is favoured by its noble gas configuration, but it is a strong oxidant reverting to the common +3 state. The E^\ominus value for Ce^{4+}/Ce^{3+} is + 1.74 V which suggests that it can oxidise water. However, the reaction rate is very slow and hence $Ce(IV)$ is a good analytical reagent. Pr, Nd, Tb and Dy also exhibit +4 state but only in oxides, MO_2 . Eu^{2+} is formed by losing the two s electrons and its f^7 configuration accounts for the formation of this ion. However, Eu^{2+} is a strong reducing agent changing to the common +3 state. Similarly Yb^{2+} which has f^{14} configuration is a reductant. Tb^{IV} has half-filled f -orbitals and is an oxidant. The behaviour of samarium is very much like europium, exhibiting both +2 and +3 oxidation states.

Table 8.9: Electronic Configurations and Radii of Lanthanum and Lanthanoids

Atomic Number	Name	Symbol	Electronic configurations*			Radii/pm		
			Ln	Ln ²⁺	Ln ³⁺	Ln ⁴⁺	Ln	Ln ³⁺
57	Lanthanum	La	5d ¹ 6s ²	5d ¹	4f ⁰		187	106
58	Cerium	Ce	4f ¹ 5d ¹ 6s ²	4f ²	4f ¹	4f ⁰	183	103
59	Praseodymium	Pr	4f ³ 6s ²	4f ³	4f ²	4f ¹	182	101
60	Neodymium	Nd	4f ⁴ 6s ²	4f ⁴	4f ³	4f ²	181	99
61	Promethium	Pm	4f ⁵ 6s ²	4f ⁵	4f ⁴		181	98
62	Samarium	Sm	4f ⁶ 6s ²	4f ⁶	4f ⁵		180	96
63	Europium	Eu	4f ⁷ 6s ²	4f ⁷	4f ⁶		199	95
64	Gadolinium	Gd	4f ⁷ 5d ¹ 6s ²	4f ⁷ 5d ¹	4f ⁷		180	94
65	Terbium	Tb	4f ⁹ 6s ²	4f ⁹	4f ⁸	4f ⁷	178	92
66	Dysprosium	Dy	4f ¹⁰ 6s ²	4f ¹⁰	4f ⁹	4f ⁸	177	91
67	Holmium	Ho	4f ¹¹ 6s ²	4f ¹¹	4f ¹⁰		176	89
68	Erbium	Er	4f ¹² 6s ²	4f ¹²	4f ¹¹		175	88
69	Thulium	Tm	4f ¹³ 6s ²	4f ¹³	4f ¹²		174	87
70	Ytterbium	Yb	4f ¹⁴ 6s ²	4f ¹⁴	4f ¹³		173	86
71	Lutetium	Lu	4f ¹⁴ 5d ¹ 6s ²	4f ¹⁴ 5d ¹	4f ¹⁴	-	-	-

* Only electrons outside [Xe] core are indicated

8.5.4 General Characteristics

All the lanthanoids are silvery white soft metals and tarnish rapidly in air. The hardness increases with increasing atomic number, samarium being steel hard. Their melting points range between 1000 to 1200 K but samarium melts at 1623 K. They have typical metallic structure and are good conductors of heat and electricity. Density and other properties change smoothly except for Eu and Yb and occasionally for Sm and Tm.

Many trivalent lanthanoid ions are coloured both in the solid state and in aqueous solutions. Colour of these ions may be attributed to the presence of *f* electrons. Neither La³⁺ nor Lu³⁺ ion shows any colour but the rest do so. However, absorption bands are narrow, probably because of the excitation within *f* level. The lanthanoid ions other than the *f*⁰ type (La³⁺ and Ce⁴⁺) and the *f*¹⁴ type (Yb²⁺ and Lu³⁺) are all paramagnetic. The paramagnetism rises to maximum in neodymium.

The first ionisation enthalpies of the lanthanoids are around 600 kJ mol⁻¹, the second about 1200 kJ mol⁻¹ comparable with those of calcium. A detailed discussion of the variation of the third ionisation enthalpies indicates that the exchange enthalpy considerations (as in 3*d* orbitals of the first transition series), appear to impart a certain degree of stability to empty, half-filled and completely filled orbitals *f* level. This is indicated from the abnormally low value of the third ionisation enthalpy of lanthanum, gadolinium and lutetium.

In their chemical behaviour, in general, the earlier members of the series are quite reactive similar to calcium but, with increasing atomic number, they behave more like aluminium. Values for *E*[⊖] for the half-reaction:

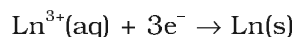

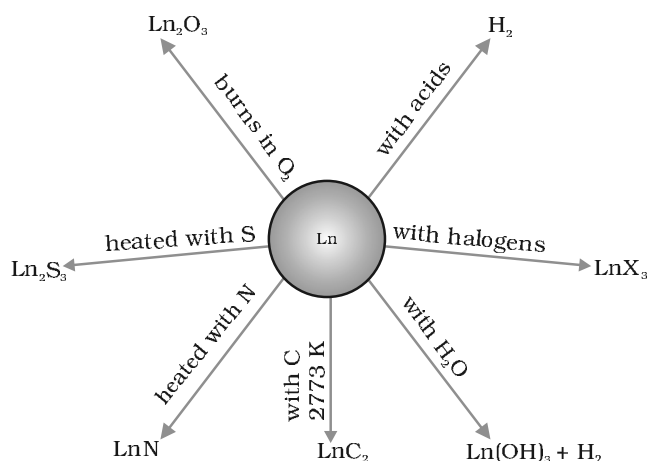

Fig 8.7: Chemical reactions of the lanthanoids.

are in the range of -2.2 to -2.4 V except for Eu for which the value is -2.0 V. This is, of course, a small variation. The metals combine with hydrogen when gently heated in the gas. The carbides, Ln_3C , Ln_2C_3 and LnC_2 are formed when the metals are heated with carbon. They liberate hydrogen from dilute acids and burn in halogens to form halides. They form oxides M_2O_3 and hydroxides $\text{M}(\text{OH})_3$. The hydroxides are definite compounds, not just hydrated oxides. They are basic like alkaline earth metal oxides and hydroxides. Their general reactions are depicted in Fig. 8.7.

The best single use of the lanthanoids is for the production of alloy steels for plates and pipes. A well known alloy is *mischmetal* which consists of a lanthanoid metal ($\sim 95\%$) and iron ($\sim 5\%$) and traces of S, C, Ca and Al. A good deal of mischmetal is used in Mg-based alloy to produce bullets, shell and lighter flint. Mixed oxides of lanthanoids are employed as catalysts in petroleum cracking. Some individual Ln oxides are used as phosphors in television screens and similar fluorescing surfaces.

8.6 The Actinoids

The actinoids include the fourteen elements from Th to Lr. The names, symbols and some properties of these elements are given in Table 8.10.

Table 8.10: Some Properties of Actinium and Actinoids

Atomic Number	Name	Symbol	Electronic configurations*		Radii/pm		
			M	M^{3+}	M^{4+}	M^{3+}	M^{4+}
89	Actinium	Ac	$6d^1 7s^2$	$5f^0$		111	
90	Thorium	Th	$6d^2 7s^2$	$5f^1$	$5f^0$		99
91	Protactinium	Pa	$5f^2 6d^1 7s^2$	$5f^2$	$5f^1$		96
92	Uranium	U	$5f^3 6d^1 7s^2$	$5f^3$	$5f^2$	103	93
93	Neptunium	Np	$5f^4 6d^1 7s^2$	$5f^4$	$5f^3$	101	92
94	Plutonium	Pu	$5f^6 7s^2$	$5f^5$	$5f^4$	100	90
95	Americium	Am	$5f^7 7s^2$	$5f^6$	$5f^5$	99	89
96	Curium	Cm	$5f^7 6d^1 7s^2$	$5f^7$	$5f^7$	99	88
97	Berkelium	Bk	$5f^9 7s^2$	$5f^8$	$5f^7$	98	87
98	Californium	Cf	$5f^{10} 7s^2$	$5f^9$	$5f^8$	98	86
99	Einsteinium	Es	$5f^{11} 7s^2$	$5f^{10}$	$5f^9$	–	–
100	Fermium	Fm	$5f^{12} 7s^2$	$5f^{11}$	$5f^{10}$	–	–
101	Mendelevium	Md	$5f^{13} 7s^2$	$5f^{12}$	$5f^{11}$	–	–
102	Nobelium	No	$5f^{14} 7s^2$	$5f^{13}$	$5f^{12}$	–	–
103	Lawrencium	Lr	$5f^{14} 6d^1 7s^2$	$5f^{14}$	$5f^{13}$	–	–

The actinoids are radioactive elements and the earlier members have relatively long half-lives, the latter ones have half-life values ranging from a day to 3 minutes for lawrencium ($Z=103$). The latter members could be prepared only in nanogram quantities. These facts render their study more difficult.

8.6.1 Electronic Configurations

All the actinoids are believed to have the electronic configuration of $7s^2$ and variable occupancy of the $5f$ and $6d$ subshells. The fourteen electrons are formally added to $5f$, though not in thorium ($Z = 90$) but from Pa onwards the $5f$ orbitals are complete at element 103. The irregularities in the electronic configurations of the actinoids, like those in the lanthanoids are related to the stabilities of the f^0 , f^7 and f^{14} occupancies of the $5f$ orbitals. Thus, the configurations of Am and Cm are $[Rn] 5f^7 7s^2$ and $[Rn] 5f^7 6d^1 7s^2$. Although the $5f$ orbitals resemble the $4f$ orbitals in their angular part of the wave-function, they are not as buried as $4f$ orbitals and hence $5f$ electrons can participate in bonding to a far greater extent.

8.6.2 Ionic Sizes

The general trend in lanthanoids is observable in the actinoids as well. There is a gradual decrease in the size of atoms or M^{3+} ions across the series. This may be referred to as the *actinoid contraction* (like lanthanoid contraction). The contraction is, however, greater from element to element in this series resulting from poor shielding by $5f$ electrons.

8.6.3 Oxidation States

There is a greater range of oxidation states, which is in part attributed to the fact that the $5f$, $6d$ and $7s$ levels are of comparable energies. The known oxidation states of actinoids are listed in Table 8.11.

The actinoids show in general +3 oxidation state. The elements, in the first half of the series frequently exhibit higher oxidation states. For example, the maximum oxidation state increases from +4 in Th to +5, +6 and +7 respectively in Pa, U and Np but decreases in succeeding elements (Table 8.11). The actinoids resemble the lanthanoids in having more compounds in +3 state than in the +4 state. However, +3 and +4 ions tend to hydrolyse. Because the distribution of oxidation states among the actinoids is so uneven and so different for the earlier and latter elements, it is unsatisfactory to review their chemistry in terms of oxidation states.

Table 8.11: Oxidation States of Actinium and Actinoids

Ac	Th	Pa	U	Np	Pu	Am	Cm	Bk	Cf	Es	Fm	Md	No	Lr
3		3	3	3	3	3	3	3	3	3	3	3	3	3
	4	4	4	4	4	4	4	4						
		5	5	5	5	5								
			6	6	6	6								
				7	7									

8.6.4 General Characteristics and Comparison with Lanthanoids

The actinoid metals are all silvery in appearance but display a variety of structures. The structural variability is obtained due to irregularities in metallic radii which are far greater than in lanthanoids.

The actinoids are highly reactive metals, especially when finely divided. The action of boiling water on them, for example, gives a mixture of oxide and hydride and combination with most non metals takes place at moderate temperatures. Hydrochloric acid attacks all metals but most are slightly affected by nitric acid owing to the formation of protective oxide layers; alkalis have no action.

The magnetic properties of the actinoids are more complex than those of the lanthanoids. Although the variation in the magnetic susceptibility of the actinoids with the number of unpaired 5 *f* electrons is roughly parallel to the corresponding results for the lanthanoids, the latter have higher values.

It is evident from the behaviour of the actinoids that the ionisation enthalpies of the early actinoids, though not accurately known, but are lower than for the early lanthanoids. This is quite reasonable since it is to be expected that when 5*f* orbitals are beginning to be occupied, they will penetrate less into the inner core of electrons. The 5*f* electrons, will therefore, be more effectively shielded from the nuclear charge than the 4*f* electrons of the corresponding lanthanoids. Because the outer electrons are less firmly held, they are available for bonding in the actinoids.

A comparison of the actinoids with the lanthanoids, with respect to different characteristics as discussed above, reveals that behaviour similar to that of the lanthanoids is not evident until the second half of the actinoid series. However, even the early actinoids resemble the lanthanoids in showing close similarities with each other and in gradual variation in properties which do not entail change in oxidation state. The lanthanoid and actinoid contractions, have extended effects on the sizes, and therefore, the properties of the elements succeeding them in their respective periods. The lanthanoid contraction is more important because the chemistry of elements succeeding the actinoids are much less known at the present time.

Example 8.10 Name a member of the lanthanoid series which is well known to exhibit +4 oxidation state.

Solution Cerium ($Z = 58$)

Intext Question

8.10 Actinoid contraction is greater from element to element than lanthanoid contraction. Why?

8.7 Some Applications of *d*- and *f*-Block Elements

Iron and steels are the most important construction materials. Their production is based on the reduction of iron oxides, the removal of impurities and the addition of carbon and alloying metals such as Cr, Mn and Ni. Some compounds are manufactured for special purposes such as TiO for the pigment industry and MnO₂ for use in dry battery cells. The battery industry also requires Zn and Ni/Cd. The elements of Group 11 are still worthy of being called the coinage metals, although Ag and Au

are restricted to collection items and the contemporary UK 'copper' coins are copper-coated steel. The 'silver' UK coins are a Cu/Ni alloy. Many of the metals and/or their compounds are essential catalysts in the chemical industry. V_2O_5 catalyses the oxidation of SO_2 in the manufacture of sulphuric acid. $TiCl_4$ with $Al(CH_3)_3$ forms the basis of the Ziegler catalysts used to manufacture polyethylene (polythene). Iron catalysts are used in the Haber process for the production of ammonia from N_2/H_2 mixtures. Nickel catalysts enable the hydrogenation of fats to proceed. In the Wacker process the oxidation of ethyne to ethanal is catalysed by $PdCl_2$. Nickel complexes are useful in the polymerisation of alkynes and other organic compounds such as benzene. The photographic industry relies on the special light-sensitive properties of AgBr.

Summary

The **d-block** consisting of **Groups 3-12** occupies the large middle section of the **periodic table**. In these elements the inner *d* orbitals are progressively filled. The **f-block** is placed **outside** at the **bottom** of the **periodic table** and in the elements of this block, *4f* and *5f* orbitals are progressively filled.

Corresponding to the filling of *3d*, *4d* and *5d* orbitals, three series of transition elements are well recognised. All the transition elements exhibit typical metallic properties such as high tensile strength, ductility, malleability, thermal and electrical conductivity and metallic character. Their melting and boiling points are high which are attributed to the involvement of $(n-1)d$ electrons resulting into **strong interatomic bonding**. In many of these properties, the maxima occur at about the middle of each series which indicates that one unpaired electron per *d* orbital is particularly a favourable configuration for strong interatomic interaction.

Successive ionisation enthalpies do not increase as steeply as in the main group elements with increasing atomic number. Hence, the loss of variable number of electrons from $(n-1)d$ orbitals is not energetically unfavourable. The involvement of $(n-1)d$ electrons in the behaviour of transition elements impart certain distinct characteristics to these elements. Thus, in addition to variable oxidation states, they exhibit paramagnetic behaviour, catalytic properties and tendency for the formation of coloured ions, interstitial compounds and complexes.

The **transition elements** vary widely in their chemical behaviour. Many of them are sufficiently electropositive to dissolve in mineral acids, although a few are 'noble'. Of the first series, with the exception of copper, all the metals are relatively reactive.

The transition metals react with a number of non-metals like oxygen, nitrogen, sulphur and halogens to form binary compounds. The first series transition metal oxides are generally formed from the reaction of metals with oxygen at high temperatures. These oxides dissolve in acids and bases to form oxometallic salts. Potassium dichromate and potassium permanganate are common examples. Potassium dichromate is prepared from the chromite ore by fusion with alkali in presence of air and acidifying the extract. Pyrolusite ore (MnO_2) is used for the preparation of potassium permanganate. Both the dichromate and the permanganate ions are strong oxidising agents.

The two series of **inner transition elements**, **lanthanoids** and **actinoids** constitute the **f-block** of the periodic table. With the successive filling of the inner orbitals, *4f*, there is a gradual decrease in the atomic and ionic sizes of these metals along the series (**lanthanoid contraction**). This has far reaching consequences in the chemistry of the elements succeeding them. Lanthanum and all the lanthanoids are rather soft white metals. They react easily with water to give solutions giving +3 ions. The principal oxidation state is +3, although +4 and +2 oxidation states are also exhibited by some

occasionally. The chemistry of the **actinoids** is more complex in view of their ability to exist in different oxidation states. Furthermore, many of the actinoid elements are radioactive which make the study of these elements rather difficult.

There are many useful applications of the *d*- and *f*-block elements and their compounds, notable among them being in varieties of steels, catalysts, complexes, organic syntheses, etc.

Exercises

- 8.1** Write down the electronic configuration of:
- | | | | |
|-----------------------|-----------------------|-----------------------|-------------------------|
| (i) Cr ³⁺ | (iii) Cu ⁺ | (v) Co ²⁺ | (vii) Mn ²⁺ |
| (ii) Pm ³⁺ | (iv) Ce ⁴⁺ | (vi) Lu ²⁺ | (viii) Th ⁴⁺ |
- 8.2** Why are Mn²⁺ compounds more stable than Fe²⁺ towards oxidation to their +3 state?
- 8.3** Explain briefly how +2 state becomes more and more stable in the first half of the first row transition elements with increasing atomic number?
- 8.4** To what extent do the electronic configurations decide the stability of oxidation states in the first series of the transition elements? Illustrate your answer with examples.
- 8.5** What may be the stable oxidation state of the transition element with the following *d* electron configurations in the ground state of their atoms : 3*d*³, 3*d*⁵, 3*d*⁸ and 3*d*⁴?
- 8.6** Name the oxometal anions of the first series of the transition metals in which the metal exhibits the oxidation state equal to its group number.
- 8.7** What is lanthanoid contraction? What are the consequences of lanthanoid contraction?
- 8.8** What are the characteristics of the transition elements and why are they called transition elements? Which of the *d*-block elements may not be regarded as the transition elements?
- 8.9** In what way is the electronic configuration of the transition elements different from that of the non transition elements?
- 8.10** What are the different oxidation states exhibited by the lanthanoids?
- 8.11** Explain giving reasons:
- Transition metals and many of their compounds show paramagnetic behaviour.
 - The enthalpies of atomisation of the transition metals are high.
 - The transition metals generally form coloured compounds.
 - Transition metals and their many compounds act as good catalyst.
- 8.12** What are interstitial compounds? Why are such compounds well known for transition metals?
- 8.13** How is the variability in oxidation states of transition metals different from that of the non transition metals? Illustrate with examples.
- 8.14** Describe the preparation of potassium dichromate from iron chromite ore. What is the effect of increasing pH on a solution of potassium dichromate?
- 8.15** Describe the oxidising action of potassium dichromate and write the ionic equations for its reaction with:
- | | | |
|------------|----------------------------|------------------------|
| (i) iodide | (ii) iron(II) solution and | (iii) H ₂ S |
|------------|----------------------------|------------------------|

- 8.16** Describe the preparation of potassium permanganate. How does the acidified permanganate solution react with (i) iron(II) ions (ii) SO_2 and (iii) oxalic acid? Write the ionic equations for the reactions.
- 8.17** For M^{2+}/M and $\text{M}^{3+}/\text{M}^{2+}$ systems the E^\ominus values for some metals are as follows:
- | | | | |
|----------------------------|-------|---------------------------------|--------|
| Cr^{2+}/Cr | -0.9V | $\text{Cr}^{3+}/\text{Cr}^{2+}$ | -0.4 V |
| Mn^{2+}/Mn | -1.2V | $\text{Mn}^{3+}/\text{Mn}^{2+}$ | +1.5 V |
| Fe^{2+}/Fe | -0.4V | $\text{Fe}^{3+}/\text{Fe}^{2+}$ | +0.8 V |
- Use this data to comment upon:
- (i) the stability of Fe^{3+} in acid solution as compared to that of Cr^{3+} or Mn^{3+} and
 - (ii) the ease with which iron can be oxidised as compared to a similar process for either chromium or manganese metal.
- 8.18** Predict which of the following will be coloured in aqueous solution? Ti^{3+} , V^{3+} , Cu^+ , Sc^{3+} , Mn^{2+} , Fe^{3+} and Co^{2+} . Give reasons for each.
- 8.19** Compare the stability of +2 oxidation state for the elements of the first transition series.
- 8.20** Compare the chemistry of actinoids with that of the lanthanoids with special reference to:
- (i) electronic configuration
 - (ii) atomic and ionic sizes and
 - (iii) oxidation state
 - (iv) chemical reactivity.
- 8.21** How would you account for the following:
- (i) Of the d^1 species, Cr^{2+} is strongly reducing while manganese(III) is strongly oxidising.
 - (ii) Cobalt(II) is stable in aqueous solution but in the presence of complexing reagents it is easily oxidised.
 - (iii) The d^1 configuration is very unstable in ions.
- 8.22** What is meant by 'disproportionation'? Give two examples of disproportionation reaction in aqueous solution.
- 8.23** Which metal in the first series of transition metals exhibits +1 oxidation state most frequently and why?
- 8.24** Calculate the number of unpaired electrons in the following gaseous ions: Mn^{3+} , Cr^{3+} , V^{3+} and Ti^{3+} . Which one of these is the most stable in aqueous solution?
- 8.25** Give examples and suggest reasons for the following features of the transition metal chemistry:
- (i) The lowest oxide of transition metal is basic, the highest is amphoteric/acidic.
 - (ii) A transition metal exhibits highest oxidation state in oxides and fluorides.
 - (iii) The highest oxidation state is exhibited in oxoanions of a metal.
- 8.26** Indicate the steps in the preparation of:
- (i) $\text{K}_2\text{Cr}_2\text{O}_7$ from chromite ore.
 - (ii) KMnO_4 from pyrolusite ore.
- 8.27** What are alloys? Name an important alloy which contains some of the lanthanoid metals. Mention its uses.
- 8.28** What are inner transition elements? Decide which of the following atomic numbers are the atomic numbers of the inner transition elements : 29, 59, 74, 95, 102, 104.
- 8.29** The chemistry of the actinoid elements is not so smooth as that of the lanthanoids. Justify this statement by giving some examples from the oxidation state of these elements.
- 8.30** Which is the last element in the series of the actinoids? Write the electronic configuration of this element. Comment on the possible oxidation state of this element.

- 8.31** Use Hund's rule to derive the electronic configuration of Ce^{3+} ion, and calculate its magnetic moment on the basis of 'spin-only' formula.
- 8.32** Name the members of the lanthanoid series which exhibit +4 oxidation states and those which exhibit +2 oxidation states. Try to correlate this type of behaviour with the electronic configurations of these elements.
- 8.33** Compare the chemistry of the actinoids with that of lanthanoids with reference to: (i) electronic configuration (ii) oxidation states and (iii) chemical reactivity.
- 8.34** Write the electronic configurations of the elements with the atomic numbers 61, 91, 101, and 109.
- 8.35** Compare the general characteristics of the first series of the transition metals with those of the second and third series metals in the respective vertical columns. Give special emphasis on the following points:
(i) electronic configurations (ii) oxidation states (iii) ionisation enthalpies and (iv) atomic sizes.
- 8.36** Write down the number of 3d electrons in each of the following ions: Ti^{2+} , V^{2+} , Cr^{3+} , Mn^{2+} , Fe^{2+} , Fe^{3+} , Co^{2+} , Ni^{2+} and Cu^{2+} . Indicate how would you expect the five 3d orbitals to be occupied for these hydrated ions (octahedral).
- 8.37** Comment on the statement that elements of the first transition series possess many properties different from those of heavier transition elements.
- 8.38** What can be inferred from the magnetic moment values of the following complex species ?

Example	Magnetic Moment (BM)
$\text{K}_4[\text{Mn}(\text{CN})_6]$	2.2
$[\text{Fe}(\text{H}_2\text{O})_6]^{2+}$	5.3
$\text{K}_2[\text{MnCl}_4]$	5.9

Answers to Some Intext Questions

- 8.1** Silver ($Z = 47$) can exhibit +2 oxidation state wherein it will have incompletely filled d -orbitals ($4d$), hence a transition element.
- 8.2** In the formation of metallic bonds, no electrons from $3d$ -orbitals are involved in case of zinc, while in all other metals of the $3d$ series, electrons from the d -orbitals are always involved in the formation of metallic bonds.
- 8.3** Manganese ($Z = 25$), as its atom has the maximum number of unpaired electrons.
- 8.5** Irregular variation of ionisation enthalpies is mainly attributed to varying degree of stability of different $3d$ -configurations (e.g., d^0 , d^5 , d^{10} are exceptionally stable).
- 8.6** Because of small size and high electronegativity oxygen or fluorine can oxidise the metal to its highest oxidation state.
- 8.7** Cr^{2+} is stronger reducing agent than Fe^{2+}
Reason: $d^4 \rightarrow d^3$ occurs in case of Cr^{2+} to Cr^{3+}
But $d^6 \rightarrow d^5$ occurs in case of Fe^{2+} to Fe^{3+}
In a medium (like water) d^3 is more stable as compared to d^5 (see CFSE)
- 8.9** Cu^+ in aqueous solution undergoes disproportionation, i.e.,
 $2\text{Cu}^+(\text{aq}) \rightarrow \text{Cu}^{2+}(\text{aq}) + \text{Cu}(\text{s})$
The E^0 value for this is favourable.
- 8.10** The $5f$ electrons are more effectively shielded from nuclear charge. In other words the $5f$ electrons themselves provide poor shielding from element to element in the series.

Unit

9

Coordination Compounds

Objectives

After studying this Unit, you will be able to

- appreciate the postulates of Werner's theory of coordination compounds;
- know the meaning of the terms: coordination entity, central atom/ion, ligand, coordination number, coordination sphere, coordination polyhedron, oxidation number, homoleptic and heteroleptic;
- learn the rules of nomenclature of coordination compounds;
- write the formulas and names of mononuclear coordination compounds;
- define different types of isomerism in coordination compounds;
- understand the nature of bonding in coordination compounds in terms of the Valence Bond and Crystal Field theories;
- learn the stability of coordination compounds;
- appreciate the importance and applications of coordination compounds in our day to day life.

Coordination Compounds are the backbone of modern inorganic and bio-inorganic chemistry and chemical industry.

In the previous Unit we learnt that the transition metals form a large number of **complex compounds** in which the metal atoms are bound to a number of anions or neutral molecules. In modern terminology such compounds are called **coordination compounds**. The chemistry of coordination compounds is an important and challenging area of modern inorganic chemistry. New concepts of chemical bonding and molecular structure have provided insights into the functioning of vital components of biological systems. Chlorophyll, haemoglobin and vitamin B₁₂ are coordination compounds of magnesium, iron and cobalt respectively. Variety of metallurgical processes, industrial catalysts and analytical reagents involve the use of coordination compounds. Coordination compounds also find many applications in electroplating, textile dyeing and medicinal chemistry.

9.1 Werner's Theory of Coordination Compounds

Alfred Werner (1866-1919), a Swiss chemist was the first to formulate his ideas about the structures of coordination compounds. He prepared and characterised a large number of coordination compounds and studied their physical and chemical behaviour by simple experimental techniques. Werner proposed the concept of a **primary valence** and a **secondary valence** for a metal ion. Binary compounds such as CrCl₃, CoCl₂ or PdCl₂ have primary valence of 3, 2 and 2 respectively. In a series of compounds of cobalt(III) chloride with ammonia, it was found that some of the chloride ions could be precipitated as AgCl on adding excess silver nitrate solution in cold but some remained in solution.

1 mol	CoCl ₃ .6NH ₃ (Yellow)	gave	3 mol AgCl
1 mol	CoCl ₃ .5NH ₃ (Purple)	gave	2 mol AgCl
1 mol	CoCl ₃ .4NH ₃ (Green)	gave	1 mol AgCl
1 mol	CoCl ₃ .4NH ₃ (Violet)	gave	1 mol AgCl

These observations, together with the results of conductivity measurements in solution can be explained if (i) six groups in all, either chloride ions or ammonia molecules or both, remain bonded to the cobalt ion during the reaction and (ii) the compounds are formulated as shown in Table 9.1, where the atoms within the square brackets form a single entity which does not dissociate under the reaction conditions. Werner proposed the term **secondary valence** for the number of groups bound directly to the metal ion; in each of these examples the secondary valences are six.

Table 9.1: Formulation of Cobalt(III) Chloride-Ammonia Complexes

Colour	Formula	Solution conductivity corresponds to
Yellow	[Co(NH ₃) ₆] ³⁺ 3Cl ⁻	1:3 electrolyte
Purple	[CoCl(NH ₃) ₅] ²⁺ 2Cl ⁻	1:2 electrolyte
Green	[CoCl ₂ (NH ₃) ₄] ⁺ Cl ⁻	1:1 electrolyte
Violet	[CoCl ₂ (NH ₃) ₄] ⁺ Cl ⁻	1:1 electrolyte

Note that the last two compounds in Table 9.1 have identical empirical formula, CoCl₃.4NH₃, but distinct properties. Such compounds are termed as isomers. Werner in 1898, propounded his theory of coordination compounds. The main postulates are:

1. In coordination compounds metals show two types of linkages (valences)-primary and secondary.
2. The primary valences are normally ionisable and are satisfied by negative ions.
3. The secondary valences are non ionisable. These are satisfied by neutral molecules or negative ions. The secondary valence is equal to the coordination number and is fixed for a metal.
4. The ions/groups bound by the secondary linkages to the metal have characteristic spatial arrangements corresponding to different coordination numbers.

In modern formulations, such spatial arrangements are called coordination *polyhedra*. The species within the square bracket are coordination entities or complexes and the ions outside the square bracket are called counter ions.

He further postulated that octahedral, tetrahedral and square planar geometrical shapes are more common in coordination compounds of transition metals. Thus, [Co(NH₃)₆]³⁺, [CoCl(NH₃)₅]²⁺ and [CoCl₂(NH₃)₄]⁺ are octahedral entities, while [Ni(CO)₄] and [PtCl₄]²⁻ are tetrahedral and square planar, respectively.

On the basis of the following observations made with aqueous solutions, *Example Q.1* assign secondary valences to metals in the following compounds:

Formula	Moles of AgCl precipitated per mole of the compounds with excess AgNO ₃
(i) PdCl ₂ .4NH ₃	2
(ii) NiCl ₂ .6H ₂ O	2
(iii) PtCl ₄ .2HCl	0
(iv) CoCl ₃ .4NH ₃	1
(v) PtCl ₂ .2NH ₃	0

(i) Secondary 4
(iii) Secondary 6

(ii) Secondary 6
(iv) Secondary 6

(v) Secondary 4

Solution

Difference between a double salt and a complex

Both double salts as well as complexes are formed by the combination of two or more stable compounds in stoichiometric ratio. However, they differ in the fact that double salts such as carnallite, KCl.MgCl₂.6H₂O, Mohr's salt, FeSO₄.(NH₄)₂SO₄.6H₂O, potash alum, KAl(SO₄)₂.12H₂O, etc. dissociate into simple ions completely when dissolved in water. However, complex ions such as [Fe(CN)₆]⁴⁻ of K₄Fe(CN)₆, do not dissociate into Fe²⁺ and CN⁻ ions.



(1866-1919)

Werner was born on December 12, 1866, in Mülhouse, a small community in the French province of Alsace. His study of chemistry began in Karlsruhe (Germany) and continued in Zurich (Switzerland), where in his doctoral thesis in 1890, he explained the difference in properties of certain nitrogen containing organic substances on the basis of isomerism. He extended vant Hoff's theory of tetrahedral carbon atom and modified it for nitrogen. Werner showed optical and electrical differences between complex compounds based on physical measurements. In fact, Werner was the first to discover optical activity in certain coordination compounds.

He, at the age of 29 years became a full professor at Technische Hochschule in Zurich in 1895. Alfred Werner was a chemist and educationist. His accomplishments included the development of the theory of coordination compounds. This theory, in which Werner proposed revolutionary ideas about how atoms and molecules are linked together, was formulated in a span of only three years, from 1890 to 1893. The remainder of his career was spent gathering the experimental support required to validate his new ideas. Werner became the first Swiss chemist to win the Nobel Prize in 1913 for his work on the linkage of atoms and the coordination theory.

9.2 Definitions of Some Important Terms Pertaining to Coordination Compounds

(a) **Coordination entity**

A coordination entity constitutes a central metal atom or ion bonded to a fixed number of ions or molecules. For example, $[\text{CoCl}_3(\text{NH}_3)_3]$ is a coordination entity in which the cobalt ion is surrounded by three ammonia molecules and three chloride ions. Other examples are $[\text{Ni}(\text{CO})_4]$, $[\text{PtCl}_2(\text{NH}_3)_2]$, $[\text{Fe}(\text{CN})_6]^{4-}$, $[\text{Co}(\text{NH}_3)_6]^{3+}$.

(b) **Central atom/ion**

In a coordination entity, the atom/ion to which a fixed number of ions/groups are bound in a definite geometrical arrangement around it, is called the central atom or ion. For example, the central atom/ion in the coordination entities: $[\text{NiCl}_2(\text{H}_2\text{O})_4]$, $[\text{CoCl}(\text{NH}_3)_5]^{2+}$ and $[\text{Fe}(\text{CN})_6]^{3-}$ are Ni^{2+} , Co^{3+} and Fe^{3+} , respectively. These central atoms/ions are also referred to as **Lewis acids**.

(c) **Ligands**

The ions or molecules bound to the central atom/ion in the coordination entity are called ligands. These may be simple ions such as Cl^- , small molecules such as H_2O or NH_3 , larger molecules such as $\text{H}_2\text{NCH}_2\text{CH}_2\text{NH}_2$ or $\text{N}(\text{CH}_2\text{CH}_2\text{NH}_2)_3$ or even macromolecules, such as proteins.

When a ligand is bound to a metal ion through a single donor atom, as with Cl^- , H_2O or NH_3 , the ligand is said to be **unidentate**.

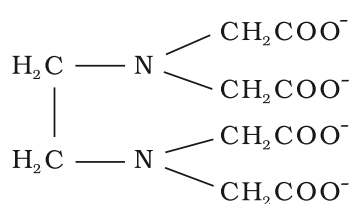

When a ligand can bind through two donor atoms as in $\text{H}_2\text{NCH}_2\text{CH}_2\text{NH}_2$ (ethane-1,2-diamine) or $\text{C}_2\text{O}_4^{2-}$ (oxalate), the ligand is said to be **didentate** and when several donor atoms are present in a single ligand as in $\text{N}(\text{CH}_2\text{CH}_2\text{NH}_2)_3$, the ligand is said to be **polydentate**. Ethylenediaminetetraacetate ion (EDTA^{4-}) is an important hexadentate ligand. It can bind through two nitrogen and four oxygen atoms to a central metal ion.

When a di- or polydentate ligand uses its two or more donor atoms to bind a single metal ion, it is said to be a **chelate** ligand. The number of such ligating groups is called the **denticity** of the ligand. Such complexes, called chelate complexes tend to be more stable than similar complexes containing unidentate ligands (for

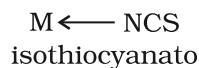
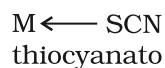
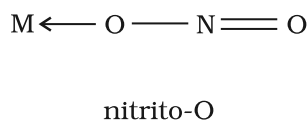
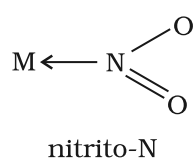

reasons see Section 9.8). Ligand which can ligate through two different atoms is called **ambidentate ligand**. Examples of such ligands are the NO_2^- and SCN^- ions. NO_2^- ion can coordinate either through nitrogen or through oxygen to a central metal atom/ion. Similarly, SCN^- ion can coordinate through the sulphur or nitrogen atom.

(d) **Coordination number**

The coordination number (CN) of a metal ion in a complex can be defined as the number of ligand donor atoms to which the metal is directly bonded. For example, in the complex ions, $[\text{PtCl}_6]^{2-}$ and $[\text{Ni}(\text{NH}_3)_4]^{2+}$, the coordination number of Pt and Ni are 6 and 4 respectively. Similarly, in the complex ions, $[\text{Fe}(\text{C}_2\text{O}_4)_3]^{3-}$ and $[\text{Co}(\text{en})_3]^{3+}$, the coordination number of both, Fe and Co, is 6 because $\text{C}_2\text{O}_4^{2-}$ and en (ethane-1,2-diamine) are didentate ligands.

It is important to note here that coordination number of the central atom/ion is determined only by the number of sigma bonds formed by the ligand with the central atom/ion. Pi bonds, if formed between the ligand and the central atom/ion, are not counted for this purpose.

(e) Coordination sphere

The central atom/ion and the ligands attached to it are enclosed in square bracket and is collectively termed as the **coordination sphere**. The ionisable groups are written outside the bracket and are called counter ions. For example, in the complex $K_4[Fe(CN)_6]$, the coordination sphere is $[Fe(CN)_6]^{4-}$ and the counter ion is K^+ .

(f) Coordination polyhedron

The spatial arrangement of the ligand atoms which are directly attached to the central atom/ion defines a coordination polyhedron about the central atom. The most common coordination polyhedra are octahedral, square planar and tetrahedral. For example, $[Co(NH_3)_6]^{3+}$ is octahedral, $[Ni(CO)_4]$ is tetrahedral and $[PtCl_4]^{2-}$ is square planar. Fig. 9.1 shows the shapes of different coordination polyhedra.

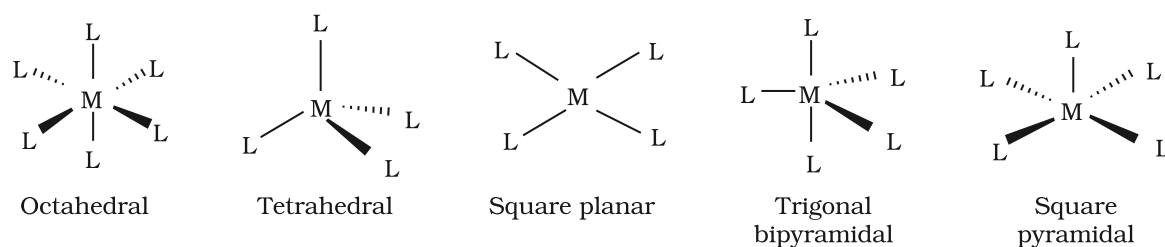

Fig. 9.1: Shapes of different coordination polyhedra. *M* represents the central atom/ion and *L*, a unidentate ligand.

(g) Oxidation number of central atom

The oxidation number of the central atom in a complex is defined as the charge it would carry if all the ligands are removed along with the electron pairs that are shared with the central atom. The oxidation number is represented by a Roman numeral in parenthesis following the name of the coordination entity. For example, oxidation number of copper in $[Cu(CN)_4]^{3-}$ is +1 and it is written as Cu(I).

(h) Homoleptic and heteroleptic complexes

Complexes in which a metal is bound to only one kind of donor groups, e.g., $[Co(NH_3)_6]^{3+}$, are known as homoleptic. Complexes in which a metal is bound to more than one kind of donor groups, e.g., $[Co(NH_3)_4Cl_2]^+$, are known as heteroleptic.

9.3 Nomenclature of Coordination Compounds

Nomenclature is important in Coordination Chemistry because of the need to have an unambiguous method of describing formulas and writing systematic names, particularly when dealing with isomers. The formulas and names adopted for coordination entities are based on the recommendations of the International Union of Pure and Applied Chemistry (IUPAC).

9.3.1 Formulas of Mononuclear Coordination Entities

The formula of a compound is a shorthand tool used to provide basic information about the constitution of the compound in a concise and convenient manner. Mononuclear coordination entities contain a single central metal atom. The following rules are applied while writing the formulas:

- (i) The central atom is listed first.
- (ii) The ligands are then listed in alphabetical order. The placement of a ligand in the list does not depend on its charge.
- (iii) Polydentate ligands are also listed alphabetically. In case of abbreviated ligand, the first letter of the abbreviation is used to determine the position of the ligand in the alphabetical order.
- (iv) The formula for the entire coordination entity, whether charged or not, is enclosed in square brackets. When ligands are polyatomic, their formulas are enclosed in parentheses. Ligand abbreviations are also enclosed in parentheses.
- (v) There should be no space between the ligands and the metal within a coordination sphere.
- (vi) When the formula of a charged coordination entity is to be written without that of the counter ion, the charge is indicated outside the square brackets as a right superscript with the number before the sign. For example, $[\text{Co}(\text{CN})_6]^{3-}$, $[\text{Cr}(\text{H}_2\text{O})_6]^{3+}$, etc.
- (vii) The charge of the cation(s) is balanced by the charge of the anion(s).

Note: The 2004 IUPAC draft recommends that ligands will be sorted alphabetically, irrespective of charge.

9.3.2 Naming of Mononuclear Coordination Compounds

The names of coordination compounds are derived by following the principles of additive nomenclature. Thus, the groups that surround the central atom must be identified in the name. They are listed as prefixes to the name of the central atom along with any appropriate multipliers. The following rules are used when naming coordination compounds:

- (i) The cation is named first in both positively and negatively charged coordination entities.
- (ii) The ligands are named in an alphabetical order before the name of the central atom/ion. (This procedure is reversed from writing formula).
- (iii) Names of the anionic ligands end in -o, those of neutral and cationic ligands are the same except aqua for H_2O , ammine for NH_3 , carbonyl for CO and nitrosyl for NO. These are placed within enclosing marks ().
- (iv) Prefixes mono, di, tri, etc., are used to indicate the number of the individual ligands in the coordination entity. When the names of the ligands include a numerical prefix, then the terms, *bis*, *tris*, *tetrakis* are used, the ligand to which they refer being placed in parentheses. For example, $[\text{NiCl}_2(\text{PPh}_3)_2]$ is named as dichlorobis(triphenylphosphine)nickel(II).
- (v) Oxidation state of the metal in cation, anion or neutral coordination entity is indicated by Roman numeral in parenthesis.
- (vi) If the complex ion is a cation, the metal is named same as the element. For example, Co in a complex cation is called cobalt and Pt is called platinum. If the complex ion is an anion, the name of the metal ends with the suffix -ate. For example, Co in a complex anion, $[\text{Co}(\text{SCN})_4]^{2-}$ is called cobaltate. For some metals, the Latin names are used in the complex anions, e.g., ferrate for Fe.

Note: The 2004 IUPAC draft recommends that anionic ligands will end with -ido so that chloro would become chlorido, etc.

(vii) The neutral complex molecule is named similar to that of the complex cation.

The following examples illustrate the nomenclature for coordination compounds.

1. $[\text{Cr}(\text{NH}_3)_3(\text{H}_2\text{O})_3]\text{Cl}_3$ is named as:
triamminetriaquachromium(III) chloride

Explanation: The complex ion is inside the square bracket, which is a cation. The amine ligands are named before the aqua ligands according to alphabetical order. Since there are three chloride ions in the compound, the charge on the complex ion must be +3 (since the compound is electrically neutral). From the charge on the complex ion and the charge on the ligands, we can calculate the oxidation number of the metal. In this example, all the ligands are neutral molecules. Therefore, the oxidation number of chromium must be the same as the charge of the complex ion, +3.

2. $[\text{Co}(\text{H}_2\text{NCH}_2\text{CH}_2\text{NH}_2)_3]_2(\text{SO}_4)_3$ is named as:
tris(ethane-1,2-diammine)cobalt(III) sulphate

Explanation: The sulphate is the counter anion in this molecule. Since it takes 3 sulphates to bond with two complex cations, the charge on each complex cation must be +3. Further, ethane-1,2-diamine is a neutral molecule, so the oxidation number of cobalt in the complex ion must be +3. Remember that you never have to indicate the number of cations and anions in the name of an ionic compound.

3. $[\text{Ag}(\text{NH}_3)_2][\text{Ag}(\text{CN})_2]$ is named as:
diamminesilver(I) dicyanoargentate(I)

Notice how the name of the metal differs in cation and anion even though they contain the same metal ions.

Example Q.2 Write the formulas for the following coordination compounds:

- (i) Tetraamineaquachloridocobalt(III) chloride
(ii) Potassium tetrahydroxozincate(II)
(iii) Potassium trioxalatoaluminate(III)
(iv) Dichloridobis(ethane-1,2-diamine)cobalt(III)
(v) Tetracarbonylnickel(0)

Solution (i) $[\text{Co}(\text{NH}_3)_4(\text{H}_2\text{O})\text{Cl}]\text{Cl}_2$ (ii) $\text{K}_2[\text{Zn}(\text{OH})_4]$ (iii) $\text{K}_3[\text{Al}(\text{C}_2\text{O}_4)_3]$
(iv) $[\text{CoCl}_2(\text{en})_2]^+$ (v) $[\text{Ni}(\text{CO})_4]$

Example Q.3 Write the IUPAC names of the following coordination compounds:

- (i) $[\text{Pt}(\text{NH}_3)_2\text{Cl}(\text{NO}_2)]$ (ii) $\text{K}_3[\text{Cr}(\text{C}_2\text{O}_4)_3]$ (iii) $[\text{CoCl}_2(\text{en})_2]\text{Cl}$
(iv) $[\text{Co}(\text{NH}_3)_5(\text{CO}_3)]\text{Cl}$ (v) $\text{Hg}[\text{Co}(\text{SCN})_4]$

Solution (i) Diamminechloridonitrito-N-platinum(II)
(ii) Potassium trioxalatochromate(III)
(iii) Dichloridobis(ethane-1,2-diamine)cobalt(III) chloride
(iv) Pentaamminecarbonatocobalt(III) chloride
(v) Mercury tetrathiocyanatocobaltate(III)

Intext Questions

9.1 Write the formulas for the following coordination compounds:

- Tetraamminediaquacobalt(III) chloride
- Potassium tetracyanonickelate(II)
- Tris(ethane-1,2-diamine) chromium(III) chloride
- Amminebromidochloridonitrito-N-platinate(II)
- Dichloridobis(ethane-1,2-diamine)platinum(IV) nitrate
- Iron(III) hexacyanoferrate(II)

9.2 Write the IUPAC names of the following coordination compounds:

- $[\text{Co}(\text{NH}_3)_6]\text{Cl}_3$
- $[\text{Co}(\text{NH}_3)_5\text{Cl}]\text{Cl}_2$
- $\text{K}_3[\text{Fe}(\text{CN})_6]$
- $\text{K}_3[\text{Fe}(\text{C}_2\text{O}_4)_3]$
- $\text{K}_2[\text{PdCl}_4]$
- $[\text{Pt}(\text{NH}_3)_2\text{Cl}(\text{NH}_2\text{CH}_3)]\text{Cl}$

9.4 Isomerism in Coordination Compounds

Isomers are two or more compounds that have the same chemical formula but a different arrangement of atoms. Because of the different arrangement of atoms, they differ in one or more physical or chemical properties. Two principal types of isomerism are known among coordination compounds. Each of which can be further subdivided.

(a) Stereoisomerism

- Geometrical isomerism
- Optical isomerism

(b) Structural isomerism

- Linkage isomerism
- Coordination isomerism
- Ionisation isomerism
- Solvate isomerism

Stereoisomers have the same chemical formula and chemical bonds but they have different spatial arrangement. Structural isomers have different bonds. A detailed account of these isomers are given below.

9.4.1 Geometric Isomerism

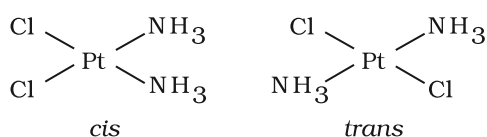

Fig. 9.2: Geometrical isomers (*cis* and *trans*) of $\text{Pt}(\text{NH}_3)_2\text{Cl}_2$

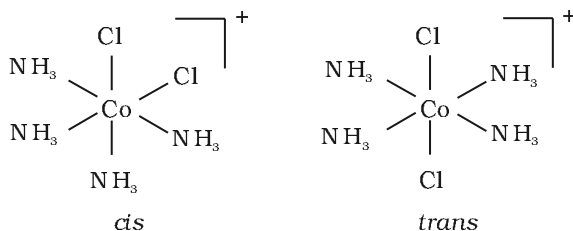

Fig. 9.3: Geometrical isomers (*cis* and *trans*) of $[\text{Co}(\text{NH}_3)_4\text{Cl}_2]^+$

This type of isomerism arises in heteroleptic complexes due to different possible geometric arrangements of the ligands. Important examples of this behaviour are found with coordination numbers 4 and 6. In a square planar complex of formula $[\text{MX}_2\text{L}_2]$ (X and L are unidentate), the two ligands X may be arranged adjacent to each other in a **cis** isomer, or opposite to each other in a **trans** isomer as depicted in Fig. 9.2.

Other square planar complex of the type MABXL (where A, B, X, L are unidentates) shows three isomers—two *cis* and one *trans*. You may attempt to draw these structures. Such isomerism is not possible for a tetrahedral geometry but similar behaviour is possible in octahedral complexes of formula $[\text{MX}_2\text{L}_4]$ in which the two ligands X may be oriented **cis** or **trans** to each other (Fig. 9.3).

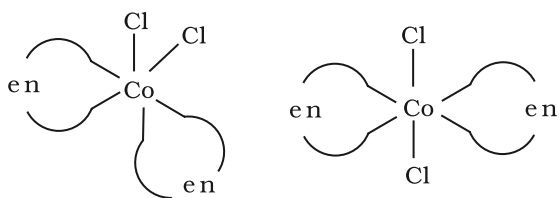
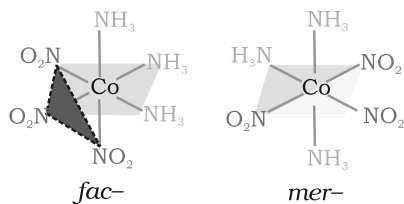

Fig. 9.4: Geometrical isomers (cis and trans) of $[\text{CoCl}_2(\text{en})_2]$

Fig. 9.5
The facial (fac) and meridional (mer) isomers of $[\text{Co}(\text{NH}_3)_3(\text{NO}_2)_3]$



This type of isomerism also arises when didentate ligands L-L [e.g., $\text{NH}_2\text{CH}_2\text{CH}_2\text{NH}_2$ (en)] are present in complexes of formula $[\text{MX}_2(\text{L}-\text{L})_2]$ (Fig. 9.4).

Another type of geometrical isomerism occurs in octahedral coordination entities of the type $[\text{Ma}_3\text{b}_3]$ like $[\text{Co}(\text{NH}_3)_3(\text{NO}_2)_3]$. If three donor atoms of the same ligands occupy adjacent positions at the corners of an octahedral face, we have the **facial (fac) isomer**. When the positions are around the meridian of the octahedron, we get the **meridional (mer) isomer** (Fig. 9.5).

Why is geometrical isomerism not possible in tetrahedral complexes having two different types of unidentate ligands coordinated with the central metal ion ?

Example 9.4

Tetrahedral complexes do not show geometrical isomerism because the relative positions of the unidentate ligands attached to the central metal atom are the same with respect to each other.

Solution

9.4.2 Optical Isomerism

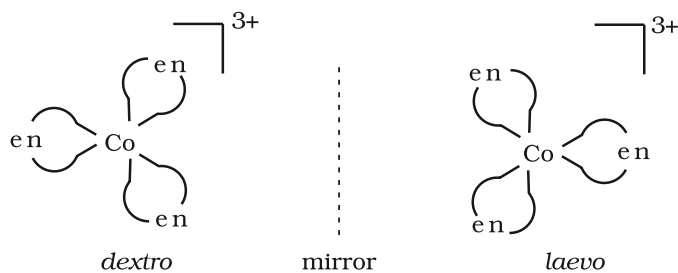
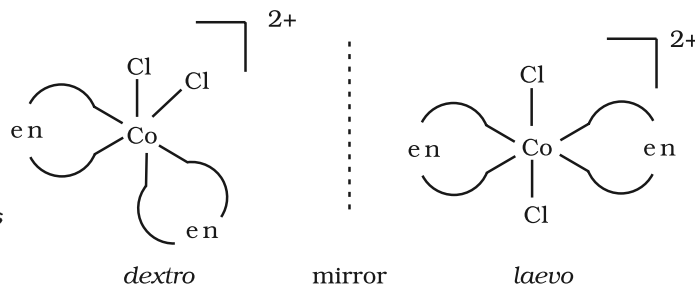

Fig.9.6: Optical isomers (d and l) of $[\text{Co}(\text{en})_3]^{3+}$

Optical isomers are mirror images that cannot be superimposed on one another. These are called as *enantiomers*. The molecules or ions that cannot be superimposed are called *chiral*. The two forms are called *dextro (d)* and *laevo (l)* depending upon the direction they rotate the plane of polarised light in a polarimeter (*d* rotates to the right, *l* to the left). Optical isomerism is common in octahedral complexes involving didentate ligands (Fig. 9.6).

Fig.9.7
Optical isomers (d and l) of cis- $[\text{PtCl}_2(\text{en})_2]^{2+}$



In a coordination entity of the type $[\text{PtCl}_2(\text{en})_2]^{2+}$, only the cis-isomer shows optical activity (Fig. 9.7).

Example 9.5 Draw structures of geometrical isomers of $[\text{Fe}(\text{NH}_3)_2(\text{CN})_4]^-$

Solution

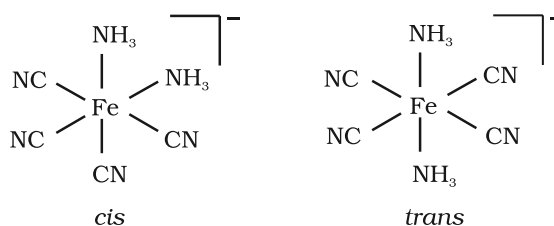

Example 9.6 Out of the following two coordination entities which is chiral (optically active)?

(a) $\text{cis}-[\text{CrCl}_2(\text{ox})_2]^{3-}$ (b) $\text{trans}-[\text{CrCl}_2(\text{ox})_2]^{3-}$

Solution The two entities are represented as

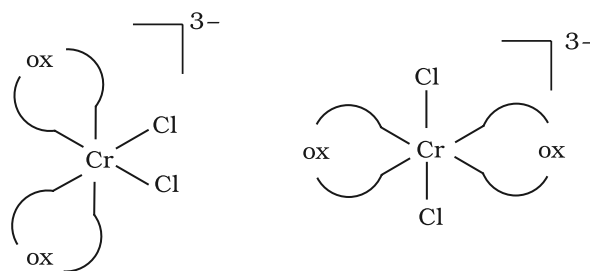

(a) $\text{cis}-[\text{CrCl}_2(\text{ox})_2]^{3-}$ (b) $\text{trans}-[\text{CrCl}_2(\text{ox})_2]^{3-}$

Out of the two, (a) $\text{cis}-[\text{CrCl}_2(\text{ox})_2]^{3-}$ is chiral (optically active).

9.4.3 Linkage Isomerism

Linkage isomerism arises in a coordination compound containing ambidentate ligand. A simple example is provided by complexes containing the thiocyanate ligand, NCS^- , which may bind through the nitrogen to give $\text{M}-\text{NCS}$ or through sulphur to give $\text{M}-\text{SCN}$. Jørgensen discovered such behaviour in the complex $[\text{Co}(\text{NH}_3)_5(\text{NO}_2)]\text{Cl}_2$, which is obtained as the red form, in which the nitrite ligand is bound through oxygen ($-\text{ONO}$), and as the yellow form, in which the nitrite ligand is bound through nitrogen ($-\text{NO}_2$).

9.4.4 Coordination Isomerism

This type of isomerism arises from the interchange of ligands between cationic and anionic entities of different metal ions present in a complex. An example is provided by $[\text{Co}(\text{NH}_3)_6][\text{Cr}(\text{CN})_6]$, in which the NH_3 ligands are bound to Co^{3+} and the CN^- ligands to Cr^{3+} . In its coordination isomer $[\text{Cr}(\text{NH}_3)_6][\text{Co}(\text{CN})_6]$, the NH_3 ligands are bound to Cr^{3+} and the CN^- ligands to Co^{3+} .

9.4.5 Ionisation Isomerism

This form of isomerism arises when the counter ion in a complex salt is itself a potential ligand and can displace a ligand which can then become the counter ion. An example is provided by the ionisation isomers $[\text{Co}(\text{NH}_3)_5\text{SO}_4]\text{Br}$ and $[\text{Co}(\text{NH}_3)_5\text{Br}]\text{SO}_4$.

9.4.6 Solvate Isomerism

This form of isomerism is known as 'hydrate isomerism' in case where water is involved as a solvent. This is similar to ionisation isomerism. Solvate isomers differ by whether or not a solvent molecule is directly bonded to the metal ion or merely present as free solvent molecules in the crystal lattice. An example is provided by the aqua complex $[\text{Cr}(\text{H}_2\text{O})_6]\text{Cl}_3$ (violet) and its solvate isomer $[\text{Cr}(\text{H}_2\text{O})_5\text{Cl}]\text{Cl}_2 \cdot \text{H}_2\text{O}$ (grey-green).

Intext Questions

9.3 Indicate the types of isomerism exhibited by the following complexes and draw the structures for these isomers:

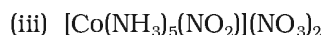
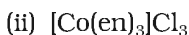
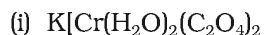

9.4 Give evidence that $[\text{Co}(\text{NH}_3)_5\text{Cl}]\text{SO}_4$ and $[\text{Co}(\text{NH}_3)_5\text{SO}_4]\text{Cl}$ are ionisation isomers.

9.5 Bonding in Coordination Compounds

Werner was the first to describe the bonding features in coordination compounds. But his theory could not answer basic questions like:

- Why only certain elements possess the remarkable property of forming coordination compounds?
- Why the bonds in coordination compounds have directional properties?
- Why coordination compounds have characteristic magnetic and optical properties?

Many approaches have been put forth to explain the nature of bonding in coordination compounds *viz.* Valence Bond Theory (VBT), Crystal Field Theory (CFT), Ligand Field Theory (LFT) and Molecular Orbital Theory (MOT). We shall focus our attention on elementary treatment of the application of VBT and CFT to coordination compounds.

9.5.1 Valence Bond Theory

According to this theory, the metal atom or ion under the influence of ligands can use its $(n-1)d$, ns , np or ns , np , nd orbitals for hybridisation to yield a set of equivalent orbitals of definite geometry such as octahedral, tetrahedral, square planar and so on (Table 9.2). These hybridised orbitals are allowed to overlap with ligand orbitals that can donate electron pairs for bonding. This is illustrated by the following examples.

Table 9.2: Number of Orbitals and Types of Hybridisations

Coordination number	Type of hybridisation	Distribution of hybrid orbitals in space
4	sp^3	Tetrahedral
4	dsp^2	Square planar
5	sp^3d	Trigonal bipyramidal
6	sp^3d^2	Octahedral
6	d^2sp^3	Octahedral

It is usually possible to predict the geometry of a complex from the knowledge of its magnetic behaviour on the basis of the valence bond theory.

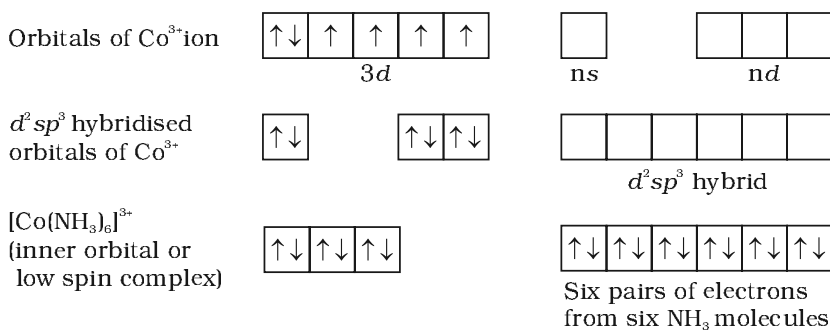

In the diamagnetic octahedral complex, $[\text{Co}(\text{NH}_3)_6]^{3+}$, the cobalt ion is in +3 oxidation state and has the electronic configuration $3d^6$. The hybridisation scheme is as shown in diagram.

Six pairs of electrons, one from each NH_3 molecule, occupy the six hybrid orbitals. Thus, the complex has octahedral geometry and is diamagnetic because of the absence of unpaired electron. In the formation of this complex, since the inner d orbital ($3d$) is used in hybridisation, the complex, $[\text{Co}(\text{NH}_3)_6]^{3+}$ is called an **inner orbital** or **low spin** or **spin paired complex**. The paramagnetic octahedral complex, $[\text{CoF}_6]^{3-}$ uses outer orbital ($4d$) in hybridisation ($sp^3 d^2$). It is thus called **outer orbital** or **high spin** or **spin free complex**. Thus:

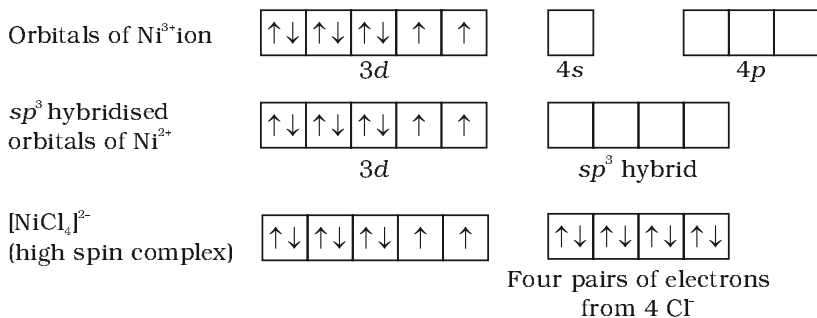
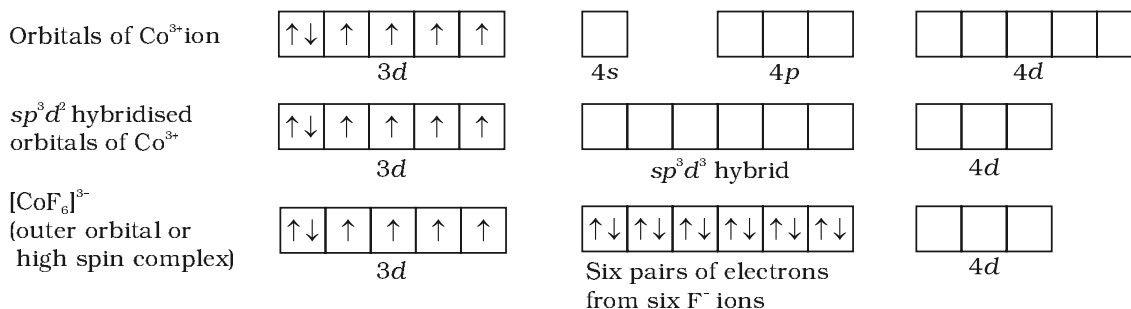

In tetrahedral complexes one s and three p orbitals are hybridised to form four equivalent orbitals oriented tetrahedrally. This is illustrated below for $[\text{NiCl}_4]^{2-}$. Here nickel is in +2 oxidation state and the ion has the electronic configuration $3d^8$. The hybridisation scheme is as shown in diagram.

Each Cl^- ion donates a pair of electrons. The compound is paramagnetic since it contains two unpaired electrons. Similarly, $[\text{Ni}(\text{CO})_4]$ has tetrahedral geometry but is diamagnetic since nickel is in zero oxidation state and contains no unpaired electron.

In the square planar complexes, the hybridisation involved is dsp^2 . An example is $[\text{Ni}(\text{CN})_4]^{2-}$. Here nickel is in +2 oxidation state and has the electronic configuration $3d^8$. The hybridisation scheme is as shown in diagram:

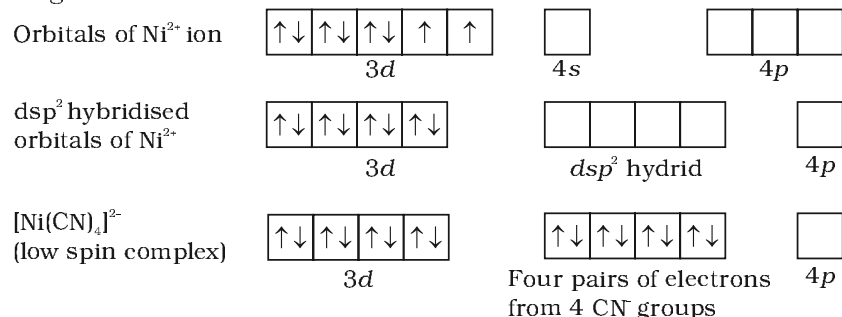

Each of the hybridised orbitals receives a pair of electrons from a cyanide ion. The compound is diamagnetic as evident from the absence of unpaired electron.

It is important to note that the hybrid orbitals do not actually exist. In fact, hybridisation is a mathematical manipulation of wave equation for the atomic orbitals involved.

9.5.2 Magnetic Properties of Coordination Compounds

The magnetic moment of coordination compounds can be measured by the magnetic susceptibility experiments. The results can be used to obtain information about the structures adopted by metal complexes.

A critical study of the magnetic data of coordination compounds of metals of the first transition series reveals some complications. For metal ions with upto three electrons in the d orbitals, like Ti^{3+} (d^1); V^{3+} (d^2); Cr^{3+} (d^3); two vacant d orbitals are available for octahedral hybridisation with $4s$ and $4p$ orbitals. The magnetic behaviour of these free ions and their coordination entities is similar. When more than three $3d$ electrons are present, the required pair of $3d$ orbitals for octahedral hybridisation is not directly available (as a consequence of Hund's rule). Thus, for d^4 (Cr^{2+} , Mn^{3+}), d^5 (Mn^{2+} , Fe^{3+}), d^6 (Fe^{2+} , Co^{3+}) cases, a vacant pair of d orbitals results only by pairing of $3d$ electrons which leaves two, one and zero unpaired electrons, respectively.

The magnetic data agree with maximum spin pairing in many cases, especially with coordination compounds containing d^8 ions. However, with species containing d^4 and d^5 ions there are complications. $[\text{Mn}(\text{CN})_6]^{3-}$ has magnetic moment of two unpaired electrons while $[\text{MnCl}_6]^{3-}$ has a paramagnetic moment of four unpaired electrons. $[\text{Fe}(\text{CN})_6]^{3-}$ has magnetic moment of a single unpaired electron while $[\text{FeF}_6]^{3-}$ has a paramagnetic moment of five unpaired electrons. $[\text{CoF}_6]^{3-}$ is paramagnetic with four unpaired electrons while $[\text{Co}(\text{C}_2\text{O}_4)_3]^{3-}$ is diamagnetic. This apparent anomaly is explained by valence bond theory in terms of formation of inner orbital and outer orbital coordination entities. $[\text{Mn}(\text{CN})_6]^{3-}$, $[\text{Fe}(\text{CN})_6]^{3-}$ and $[\text{Co}(\text{C}_2\text{O}_4)_3]^{3-}$ are inner orbital complexes involving d^2sp^3 hybridisation, the former two complexes are paramagnetic and the latter diamagnetic. On the other hand, $[\text{MnCl}_6]^{3-}$, $[\text{FeF}_6]^{3-}$ and $[\text{CoF}_6]^{3-}$ are outer orbital complexes involving sp^3d^2 hybridisation and are paramagnetic corresponding to four, five and four unpaired electrons.

Example 9.7

Solution

The spin only magnetic moment of $[\text{MnBr}_4]^{2-}$ is 5.9 BM. Predict the geometry of the complex ion ?

Since the coordination number of Mn^{2+} ion in the complex ion is 4, it will be either tetrahedral (sp^3 hybridisation) or square planar (dsp^2 hybridisation). But the fact that the magnetic moment of the complex ion is 5.9 BM, it should be tetrahedral in shape rather than square planar because of the presence of five unpaired electrons in the d orbitals.

9.5.3 Limitations of Valence Bond Theory

While the VB theory, to a larger extent, explains the formation, structures and magnetic behaviour of coordination compounds, it suffers from the following shortcomings:

- It involves a number of assumptions.
- It does not give quantitative interpretation of magnetic data.
- It does not explain the colour exhibited by coordination compounds.
- It does not give a quantitative interpretation of the thermodynamic or kinetic stabilities of coordination compounds.
- It does not make exact predictions regarding the tetrahedral and square planar structures of 4-coordinate complexes.
- It does not distinguish between weak and strong ligands.

9.5.4 Crystal Field Theory

The crystal field theory (CFT) is an electrostatic model which considers the metal-ligand bond to be ionic arising purely from electrostatic interactions between the metal ion and the ligand. Ligands are treated as point charges in case of anions or dipoles in case of neutral molecules. The five d orbitals in an isolated gaseous metal atom/ion have same energy, *i.e.*, they are degenerate. This degeneracy is maintained if a spherically symmetrical field of negative charges surrounds the metal atom/ion. However, when this negative field is due to ligands (either anions or the negative ends of dipolar molecules like NH_3 and H_2O) in a complex, it becomes asymmetrical and the degeneracy of the d orbitals is lifted. It results in splitting of the d orbitals. The pattern of splitting depends upon the nature of the crystal field. Let us explain this splitting in different crystal fields.

(a) Crystal field splitting in octahedral coordination entities

In an octahedral coordination entity with six ligands surrounding the metal atom/ion, there will be repulsion between the electrons in metal d orbitals and the electrons (or negative charges) of the ligands. Such a repulsion is more when the metal d orbital is directed towards the ligand than when it is away from the ligand. Thus, the $d_{x^2-y^2}$ and d_{z^2} orbitals which point towards the axes along the direction of the ligand will experience more repulsion and will be raised in energy; and the d_{xy} , d_{yz} and d_{zx} orbitals which are directed between the axes will be lowered in energy relative to the average energy in the spherical crystal field. Thus, the degeneracy of the d orbitals has been removed due to ligand electron-metal electron repulsions in the octahedral complex to yield three orbitals of lower energy, t_{2g} set and two orbitals of higher energy, e_g set. This splitting of the

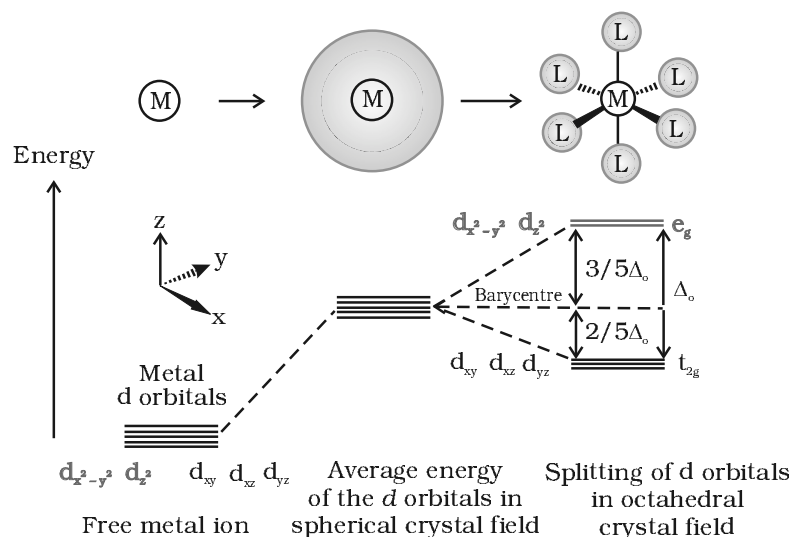
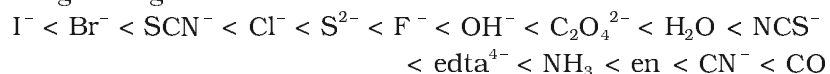

Fig.9.8: *d* orbital splitting in an octahedral crystal field

degenerate levels due to the presence of ligands in a definite geometry is termed as **crystal field splitting** and the energy separation is denoted by Δ_o (the subscript o is for octahedral) (Fig.9.8). Thus, the energy of the two e_g orbitals will increase by $(3/5) \Delta_o$ and that of the three t_{2g} will decrease by $(2/5)\Delta_o$.

The crystal field splitting, Δ_o , depends upon the field produced by the ligand and charge on the metal ion. Some ligands are able to produce strong fields in which case, the splitting will be large whereas others produce weak fields and consequently result in small splitting of *d* orbitals. In

general, ligands can be arranged in a series in the order of increasing field strength as given below:



Such a series is termed as **spectrochemical series**. It is an experimentally determined series based on the absorption of light by complexes with different ligands. Let us assign electrons in the *d* orbitals of metal ion in octahedral coordination entities. Obviously, the single *d* electron occupies one of the lower energy t_{2g} orbitals. In d^2 and d^3 coordination entities, the *d* electrons occupy the t_{2g} orbitals singly in accordance with the Hund's rule. For d^4 ions, two possible patterns of electron distribution arise: (i) the fourth electron could either enter the t_{2g} level and pair with an existing electron, or (ii) it could avoid paying the price of the pairing energy by occupying the e_g level. Which of these possibilities occurs, depends on the relative magnitude of the crystal field splitting, Δ_o and the pairing energy, *P* (*P* represents the energy required for electron pairing in a single orbital). The two options are:

- (i) If $\Delta_o < P$, the fourth electron enters one of the e_g orbitals giving the configuration $t_{2g}^3 e_g^1$. Ligands for which $\Delta_o < P$ are known as *weak field ligands* and form high spin complexes.
- (ii) If $\Delta_o > P$, it becomes more energetically favourable for the fourth electron to occupy a t_{2g} orbital with configuration $t_{2g}^4 e_g^0$. Ligands which produce this effect are known as *strong field ligands* and form low spin complexes.

Calculations show that d^4 to d^7 coordination entities are more stable for strong field as compared to weak field cases.

(b) Crystal field splitting in tetrahedral coordination entities

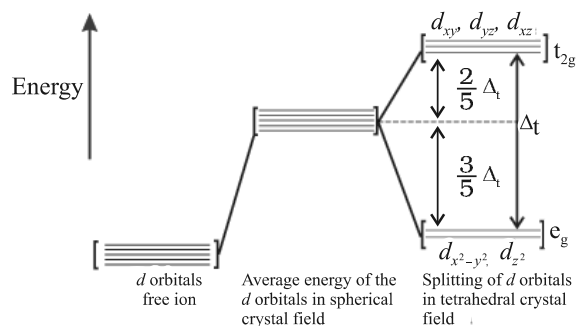

Fig.9.9: *d* orbital splitting in a tetrahedral crystal field.

In tetrahedral coordination entity formation, the *d* orbital splitting (Fig. 9.9) is inverted and is smaller as compared to the octahedral field splitting. For the same metal, the same ligands and metal-ligand distances, it can be shown that $\Delta_t = (4/9) \Delta_0$. Consequently, the orbital splitting energies are not sufficiently large for forcing pairing and, therefore, low spin configurations are rarely observed.

9.5.5 Colour in Coordination Compounds

In the previous Unit, we learnt that one of the most distinctive properties of transition metal complexes is their wide range of colours. This means that some of the visible spectrum is being removed from white light as it passes through the sample, so the light that emerges is no longer white. The colour of the complex is complementary to that which is absorbed. The complementary colour is the colour generated from the wavelength left over; if green light is absorbed by the complex, it appears red. Table 9.3 gives the relationship of the different wavelength absorbed and the colour observed.

Table 9.3: Relationship between the Wavelength of Light absorbed and the Colour observed in some Coordination Entities

Coordination entity	Wavelength of light absorbed (nm)	Colour of light absorbed	Colour of coordination entity
$[\text{CoCl}(\text{NH}_3)_5]^{2+}$	535	Yellow	Violet
$[\text{Co}(\text{NH}_3)_5(\text{H}_2\text{O})]^{3+}$	500	Blue Green	Red
$[\text{Co}(\text{NH}_3)_6]^{3+}$	475	Blue	Yellow Orange
$[\text{Co}(\text{CN})_6]^{3-}$	310	Ultraviolet	Pale Yellow
$[\text{Cu}(\text{H}_2\text{O})_4]^{2+}$	600	Red	Blue
$[\text{Ti}(\text{H}_2\text{O})_6]^{3+}$	498	Blue Green	Purple

The colour in the coordination compounds can be readily explained in terms of the crystal field theory. Consider, for example, the complex $[\text{Ti}(\text{H}_2\text{O})_6]^{3+}$, which is violet in colour. This is an octahedral complex where the single electron (Ti^{3+} is a $3d^1$ system) in the metal *d* orbital is in the t_{2g} level in the ground state of the complex. The next higher state available for the electron is the empty e_g level. If light corresponding to the energy of yellow-green region is absorbed by the complex, it would excite the electron from t_{2g} level to the e_g level ($t_{2g}^1 e_g^0 \rightarrow t_{2g}^0 e_g^1$). Consequently, the complex appears violet in colour (Fig. 9.10). The crystal field theory attributes the colour of the coordination compounds to *d-d* transition of the electron.

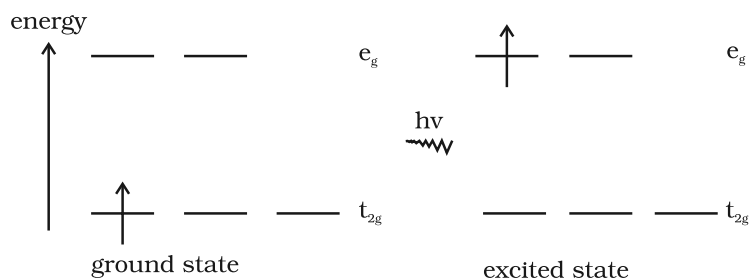
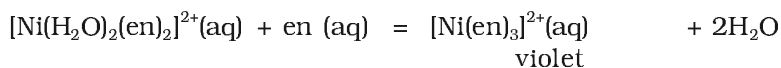
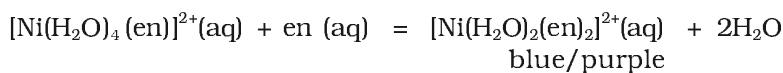
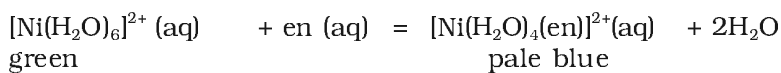

Fig.9.10: Transition of an electron in $[Ti(H_2O)_6]^{3+}$

It is important to note that in the absence of ligand, crystal field splitting does not occur and hence the substance is colourless. For example, removal of water from $[Ti(H_2O)_6]Cl_3$ on heating renders it colourless. Similarly, anhydrous $CuSO_4$ is white, but $CuSO_4 \cdot 5H_2O$ is blue in colour. The influence of the ligand on the colour

of a complex may be illustrated by considering the $[Ni(H_2O)_6]^{2+}$ complex, which forms when nickel(II) chloride is dissolved in water. If the didentate ligand, ethane-1,2-diamine(en) is progressively added in the molar ratios en:Ni, 1:1, 2:1, 3:1, the following series of reactions and their associated colour changes occur:



This sequence is shown in Fig. 9.11.

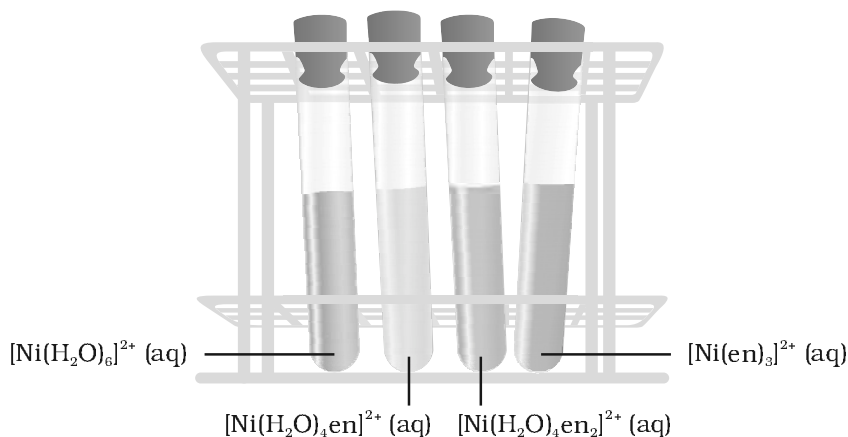

Fig.9.11
Aqueous solutions of complexes of nickel(II) with an increasing number of ethane-1,2-diamine ligands.

Colour of Some Gem Stones

The colours produced by electronic transitions within the d orbitals of a transition metal ion occur frequently in everyday life. Ruby [Fig.9.12(a)] is aluminium oxide (Al_2O_3) containing about 0.5-1% Cr^{3+} ions (d^3), which are randomly distributed in positions normally occupied by Al^{3+} . We may view these chromium(III) species as octahedral chromium(III) complexes incorporated into the alumina lattice; $d-d$ transitions at these centres give rise to the colour.

In emerald [Fig.9.12(b)], Cr^{3+} ions occupy octahedral sites in the mineral beryl ($\text{Be}_3\text{Al}_2\text{Si}_6\text{O}_{18}$). The absorption bands seen in the ruby shift to longer wavelength, namely yellow-red and blue, causing emerald to transmit light in the green region.

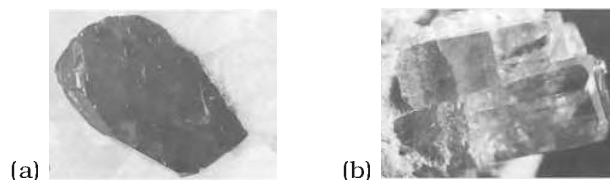

Fig.9.12: (a) Ruby: this gemstone was found in marble from Mogok, Myanmar; (b) Emerald: this gemstone was found in Muzo, Columbia.

9.5.6 Limitations of Crystal Field Theory

The crystal field model is successful in explaining the formation, structures, colour and magnetic properties of coordination compounds to a large extent. However, from the assumptions that the ligands are point charges, it follows that anionic ligands should exert the greatest splitting effect. The anionic ligands actually are found at the low end of the spectrochemical series. Further, it does not take into account the covalent character of bonding between the ligand and the central atom. These are some of the weaknesses of CFT, which are explained by ligand field theory (LFT) and molecular orbital theory which are beyond the scope of the present study.

Intext Questions

- 9.5 Explain on the basis of valence bond theory that $[\text{Ni}(\text{CN})_4]^{2-}$ ion with square planar structure is diamagnetic and the $[\text{NiCl}_4]^{2-}$ ion with tetrahedral geometry is paramagnetic.
- 9.6 $[\text{NiCl}_4]^{2-}$ is paramagnetic while $[\text{Ni}(\text{CO})_4]$ is diamagnetic though both are tetrahedral. Why?
- 9.7 $[\text{Fe}(\text{H}_2\text{O})_6]^{3+}$ is strongly paramagnetic whereas $[\text{Fe}(\text{CN})_6]^{3-}$ is weakly paramagnetic. Explain.
- 9.8 Explain $[\text{Co}(\text{NH}_3)_6]^{3+}$ is an inner orbital complex whereas $[\text{Ni}(\text{NH}_3)_6]^{2+}$ is an outer orbital complex.
- 9.9 Predict the number of unpaired electrons in the square planar $[\text{Pt}(\text{CN})_4]^{2-}$ ion.
- 9.10 The hexaquo manganese(II) ion contains five unpaired electrons, while the hexacyanoion contains only one unpaired electron. Explain using Crystal Field Theory.

9.6 Bonding in Metal Carbonyls

The homoleptic carbonyls (compounds containing carbonyl ligands only) are formed by most of the transition metals. These carbonyls have simple, well defined structures. Tetracarbonylnickel(0) is tetrahedral, pentacarbonyliron(0) is trigonalbipyramidal while hexacarbonyl chromium(0) is octahedral.

Decacarbonyldimanganese(0) is made up of two square pyramidal $\text{Mn}(\text{CO})_5$ units joined by a Mn – Mn bond. Octacarbonyldicobalt(0) has a Co – Co bond bridged by two CO groups (Fig.9.13).

Fig. 9.13
Structures of some representative homoleptic metal carbonyls.

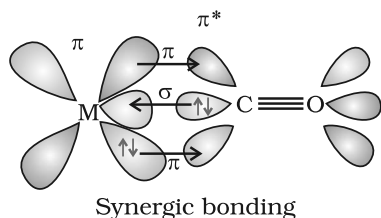
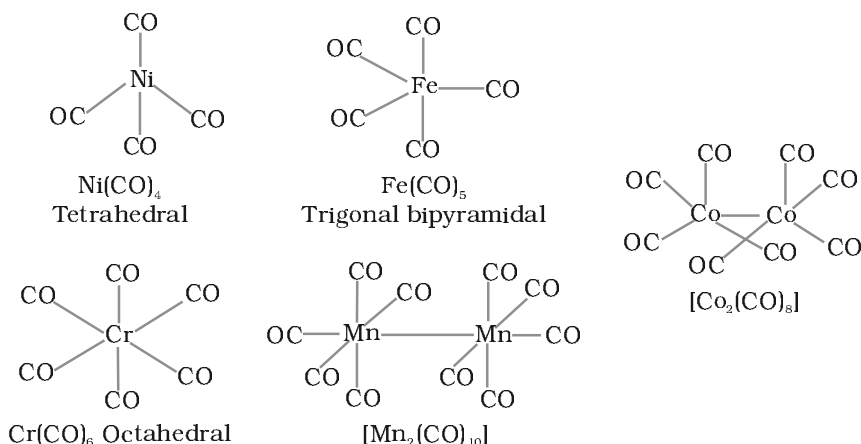
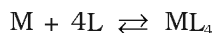

Fig. 9.14: Example of synergic bonding interactions in a carbonyl complex.

The metal-carbon bond in metal carbonyls possess both *s* and *p* character. The M–C σ bond is formed by the donation of lone pair of electrons on the carbonyl carbon into a vacant orbital of the metal. The M–C π bond is formed by the donation of a pair of electrons from a filled *d* orbital of metal into the vacant antibonding π^* orbital of carbon monoxide. The metal to ligand bonding creates a synergic effect which strengthens the bond between CO and the metal (Fig.9.14).

9.7 Stability of Coordination Compounds

The stability of a complex in solution refers to the degree of association between the two species involved in the state of equilibrium. The magnitude of the (stability or formation) equilibrium constant for the association, quantitatively expresses the stability. Thus, if we have a reaction of the type:



then the larger the stability constant, the higher the proportion of ML_4 that exists in solution. Free metal ions rarely exist in the solution so that M will usually be surrounded by solvent molecules which will compete with the ligand molecules, L, and be successively replaced by them. For simplicity, we generally ignore these solvent molecules and write four stability constants as follows:

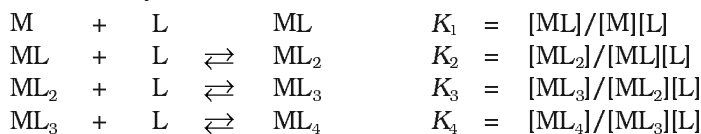

where K_1 , K_2 , etc., are referred to as **stepwise stability constants**. Alternatively, we can write the **overall stability constant** thus:



The stepwise and overall stability constant are therefore related as follows:

$$\beta_4 = K_1 \times K_2 \times K_3 \times K_4 \text{ or more generally,}$$

$$\beta_n = K_1 \times K_2 \times K_3 \times K_4 \dots\dots K_n$$

If we take as an example, the steps involved in the formation of the cuprammonium ion, we have the following:

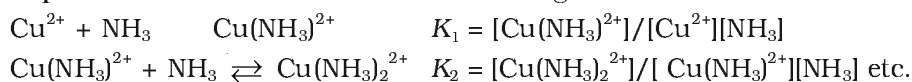

where K_1 , K_2 are the stepwise stability constants and overall stability constant.

$$\text{Also } \beta_4 = [\text{Cu}(\text{NH}_3)_4^{2+}]/[\text{Cu}^{2+}][\text{NH}_3]^4$$

The addition of the four amine groups to copper shows a pattern found for most formation constants, in that the successive stability constants decrease. In this case, the four constants are:

$$\log K_1 = 4.0, \log K_2 = 3.2, \log K_3 = 2.7, \log K_4 = 2.0 \text{ or } \log \beta_4 = 11.9$$

The **instability constant or the dissociation constant** of coordination compounds is defined as the reciprocal of the formation constant.

Intext Question

9.11 Calculate the overall complex dissociation equilibrium constant for the $\text{Cu}(\text{NH}_3)_4^{2+}$ ion, given that β_4 for this complex is 2.1×10^{13} .

9.8 Importance and Applications of Coordination Compounds

The coordination compounds are of great importance. These compounds are widely present in the mineral, plant and animal worlds and are known to play many important functions in the area of analytical chemistry, metallurgy, biological systems, industry and medicine. These are described below:

- Coordination compounds find use in many qualitative and quantitative chemical analysis. The familiar colour reactions given by metal ions with a number of ligands (especially chelating ligands), as a result of formation of coordination entities, form the basis for their detection and estimation by classical and instrumental methods of analysis. Examples of such reagents include EDTA, DMG (dimethylglyoxime), α -nitroso- β -naphthol, cupron, etc.
- Hardness of water is estimated by simple titration with Na_2EDTA . The Ca^{2+} and Mg^{2+} ions form stable complexes with EDTA. The selective estimation of these ions can be done due to difference in the stability constants of calcium and magnesium complexes.
- Some important extraction processes of metals, like those of silver and gold, make use of complex formation. Gold, for example, combines with cyanide in the presence of oxygen and water to form the coordination entity $[\text{Au}(\text{CN})_2]^-$ in aqueous solution. Gold can be separated in metallic form from this solution by the addition of zinc (Unit 6).
- Similarly, purification of metals can be achieved through formation and subsequent decomposition of their coordination compounds. For example, impure nickel is converted to $[\text{Ni}(\text{CO})_4]$, which is decomposed to yield pure nickel.

- Coordination compounds are of great importance in biological systems. The pigment responsible for photosynthesis, chlorophyll, is a coordination compound of magnesium. Haemoglobin, the red pigment of blood which acts as oxygen carrier is a coordination compound of iron. Vitamin B₁₂, cyanocobalamin, the anti-pernicious anaemia factor, is a coordination compound of cobalt. Among the other compounds of biological importance with coordinated metal ions are the enzymes like, carboxypeptidase A and carbonic anhydrase (catalysts of biological systems).
- Coordination compounds are used as catalysts for many industrial processes. Examples include rhodium complex, [(Ph₃P)₃RhCl], a Wilkinson catalyst, is used for the hydrogenation of alkenes.
- Articles can be electroplated with silver and gold much more smoothly and evenly from solutions of the complexes, [Ag(CN)₂]⁻ and [Au(CN)₂]⁻ than from a solution of simple metal ions.
- In black and white photography, the developed film is fixed by washing with hypo solution which dissolves the undecomposed AgBr to form a complex ion, [Ag(S₂O₃)₂]³⁻.
- There is growing interest in the use of chelate therapy in medicinal chemistry. An example is the treatment of problems caused by the presence of metals in toxic proportions in plant/animal systems. Thus, excess of copper and iron are removed by the chelating ligands D-penicillamine and desferrioxime B via the formation of coordination compounds. EDTA is used in the treatment of lead poisoning. Some coordination compounds of platinum effectively inhibit the growth of tumours. Examples are: *cis*-platin and related compounds.

Summary

The **chemistry of coordination compounds** is an important and challenging area of modern inorganic chemistry. During the last fifty years, advances in this area, have provided development of new concepts and models of bonding and molecular structure, novel breakthroughs in **chemical industry** and vital insights into the functioning of critical components of **biological systems**.

The first systematic attempt at explaining the formation, reactions, structure and bonding of a coordination compound was made by **A. Werner**. His theory postulated the use of two types of **linkages (primary and secondary)** by a metal atom/ion in a coordination compound. In the modern language of chemistry these linkages are recognised as the ionisable (ionic) and non-ionisable (covalent) bonds, respectively. Using the property of isomerism, Werner predicted the geometrical shapes of a large number of coordination entities.

The Valence Bond Theory (VBT) explains with reasonable success, the formation, magnetic behaviour and geometrical shapes of coordination compounds. It, however, fails to provide a quantitative interpretation of magnetic behaviour and has nothing to say about the optical properties of these compounds.

The Crystal Field Theory (CFT) to coordination compounds is based on the effect of different crystal fields (provided by the ligands taken as point charges), on the degeneracy of *d* orbital energies of the central metal atom/ion. The splitting of the *d* orbitals provides different electronic arrangements in strong and weak separation crystal fields. The treatment provides for quantitative estimations of orbital separation energies, magnetic moments and spectral and stability

parameters. However, the assumption that ligands constitute point charges creates many theoretical difficulties.

The metal-carbon bond in **metal carbonyls** possesses both σ and π character. The ligand to metal is σ bond and metal to ligand is π bond. This unique synergic bonding provides stability to metal carbonyls.

The stability of coordination compounds is measured in terms of **stepwise stability (or formation) constant (K)** or **overall stability constant (β)**. The stabilisation of coordination compound due to chelation is called the **chelate effect**. The stability of coordination compounds is related to Gibbs energy, enthalpy and entropy terms.

Coordination compounds are of great importance. These compounds provide critical insights into the functioning and structures of vital components of biological systems. Coordination compounds also find extensive applications in **metallurgical processes, analytical and medicinal chemistry**.

Exercises

- 9.1** Explain the bonding in coordination compounds in terms of Werner's postulates.
- 9.2** FeSO_4 solution mixed with $(\text{NH}_4)_2\text{SO}_4$ solution in 1:1 molar ratio gives the test of Fe^{2+} ion but CuSO_4 solution mixed with aqueous ammonia in 1:4 molar ratio does not give the test of Cu^{2+} ion. Explain why?
- 9.3** Explain with two examples each of the following: coordination entity, ligand, coordination number, coordination polyhedron, homoleptic and heteroleptic.
- 9.4** What is meant by unidentate, didentate and ambidentate ligands? Give two examples for each.
- 9.5** Specify the oxidation numbers of the metals in the following coordination entities:
 (i) $[\text{Co}(\text{H}_2\text{O})(\text{CN})(\text{en})_2]^{2+}$ (iii) $[\text{PtCl}_4]^{2-}$ (v) $[\text{Cr}(\text{NH}_3)_3\text{Cl}_3]$
 (ii) $[\text{CoBr}_2(\text{en})_2]^+$ (iv) $\text{K}_3[\text{Fe}(\text{CN})_6]$
- 9.6** Using IUPAC norms write the formulas for the following:
 (i) Tetrahydroxozincate(II) (vi) Hexaamminecobalt(III) sulphate
 (ii) Potassium tetrachloridopalladate(II) (vii) Potassium tri(oxalato)chromate(III)
 (iii) Diamminedichloridoplatinum(II) (viii) Hexaammineplatinum(IV)
 (iv) Potassium tetracyanonickelate(II) (ix) Tetrabromidocuprate(II)
 (v) Pentaamminenitrito-O-cobalt(III) (x) Pentaamminenitrito-N-cobalt(III)
- 9.7** Using IUPAC norms write the systematic names of the following:
 (i) $[\text{Co}(\text{NH}_3)_6]\text{Cl}_3$ (iv) $[\text{Co}(\text{NH}_3)_4\text{Cl}(\text{NO}_2)]\text{Cl}$ (vii) $[\text{Ni}(\text{NH}_3)_6]\text{Cl}_2$
 (ii) $[\text{Pt}(\text{NH}_3)_2\text{Cl}(\text{NH}_2\text{CH}_3)]\text{Cl}$ (v) $[\text{Mn}(\text{H}_2\text{O})_6]^{2+}$ (viii) $[\text{Co}(\text{en})_3]^{3+}$
 (iii) $[\text{Ti}(\text{H}_2\text{O})_6]^{3+}$ (vi) $[\text{NiCl}_4]^{2-}$ (ix) $[\text{Ni}(\text{CO})_4]$
- 9.8** List various types of isomerism possible for coordination compounds, giving an example of each.
- 9.9** How many geometrical isomers are possible in the following coordination entities?
 (i) $[\text{Cr}(\text{C}_2\text{O}_4)_3]^{3-}$ (ii) $[\text{Co}(\text{NH}_3)_3\text{Cl}_3]$
- 9.10** Draw the structures of optical isomers of:
 (i) $[\text{Cr}(\text{C}_2\text{O}_4)_3]^{3-}$ (ii) $[\text{PtCl}_2(\text{en})_2]^{2+}$ (iii) $[\text{Cr}(\text{NH}_3)_2\text{Cl}_2(\text{en})]^+$

- 9.11** Draw all the isomers (geometrical and optical) of:
 (i) $[\text{CoCl}_2(\text{en})_2]^+$ (ii) $[\text{Co}(\text{NH}_3)\text{Cl}(\text{en})_2]^{2+}$ (iii) $[\text{Co}(\text{NH}_3)_2\text{Cl}_2(\text{en})]^+$
- 9.12** Write all the geometrical isomers of $[\text{Pt}(\text{NH}_3)(\text{Br})(\text{Cl})(\text{py})]$ and how many of these will exhibit optical isomers?
- 9.13** Aqueous copper sulphate solution (blue in colour) gives:
 (i) a green precipitate with aqueous potassium fluoride and
 (ii) a bright green solution with aqueous potassium chloride. Explain these experimental results.
- 9.14** What is the coordination entity formed when excess of aqueous KCN is added to an aqueous solution of copper sulphate? Why is it that no precipitate of copper sulphide is obtained when $\text{H}_2\text{S}(\text{g})$ is passed through this solution?
- 9.15** Discuss the nature of bonding in the following coordination entities on the basis of valence bond theory:
 (i) $[\text{Fe}(\text{CN})_6]^{4-}$ (ii) $[\text{FeF}_6]^{3-}$ (iii) $[\text{Co}(\text{C}_2\text{O}_4)_3]^{3-}$ (iv) $[\text{CoF}_6]^{3-}$
- 9.16** Draw figure to show the splitting of d orbitals in an octahedral crystal field.
- 9.17** What is spectrochemical series? Explain the difference between a weak field ligand and a strong field ligand.
- 9.18** What is crystal field splitting energy? How does the magnitude of Δ_o decide the actual configuration of d orbitals in a coordination entity?
- 9.19** $[\text{Cr}(\text{NH}_3)_6]^{3+}$ is paramagnetic while $[\text{Ni}(\text{CN})_4]^{2-}$ is diamagnetic. Explain why?
- 9.20** A solution of $[\text{Ni}(\text{H}_2\text{O})_6]^{2+}$ is green but a solution of $[\text{Ni}(\text{CN})_4]^{2-}$ is colourless. Explain.
- 9.21** $[\text{Fe}(\text{CN})_6]^{4-}$ and $[\text{Fe}(\text{H}_2\text{O})_6]^{2+}$ are of different colours in dilute solutions. Why?
- 9.22** Discuss the nature of bonding in metal carbonyls.
- 9.23** Give the oxidation state, d orbital occupation and coordination number of the central metal ion in the following complexes:
 (i) $\text{K}_3[\text{Co}(\text{C}_2\text{O}_4)_3]$ (iii) $(\text{NH}_4)_2[\text{CoF}_4]$
 (ii) $\text{cis-}[\text{Cr}(\text{en})_2\text{Cl}_2]\text{Cl}$ (iv) $[\text{Mn}(\text{H}_2\text{O})_6]\text{SO}_4$
- 9.24** Write down the IUPAC name for each of the following complexes and indicate the oxidation state, electronic configuration and coordination number. Also give stereochemistry and magnetic moment of the complex:
 (i) $\text{K}[\text{Cr}(\text{H}_2\text{O})_2(\text{C}_2\text{O}_4)_2] \cdot 3\text{H}_2\text{O}$ (iii) $\text{CrCl}_3(\text{py})_3$ (v) $\text{K}_4[\text{Mn}(\text{CN})_6]$
 (ii) $[\text{Co}(\text{NH}_3)_5\text{Cl}]\text{Cl}_2$ (iv) $\text{Cs}[\text{FeCl}_4]$
- 9.25** What is meant by stability of a coordination compound in solution? State the factors which govern stability of complexes.
- 9.26** What is meant by the *chelate effect*? Give an example.
- 9.27** Discuss briefly giving an example in each case the role of coordination compounds in:
 (i) biological systems (iii) analytical chemistry
 (ii) medicinal chemistry and (iv) extraction/metallurgy of metals.
- 9.28** How many ions are produced from the complex $\text{Co}(\text{NH}_3)_6\text{Cl}_2$ in solution?
 (i) 6 (ii) 4 (iii) 3 (iv) 2
- 9.29** Amongst the following ions which one has the highest magnetic moment value?
 (i) $[\text{Cr}(\text{H}_2\text{O})_6]^{3+}$ (ii) $[\text{Fe}(\text{H}_2\text{O})_6]^{2+}$ (iii) $[\text{Zn}(\text{H}_2\text{O})_6]^{2+}$
- 9.30** The oxidation number of cobalt in $[\text{Co}(\text{CO})_4]$ is
 (i) +1 (ii) +3 (iii) -1 (iv) -3

- 9.31** Amongst the following, the most stable complex is
 (i) $[\text{Fe}(\text{H}_2\text{O})_6]^{3+}$ (ii) $[\text{Fe}(\text{NH}_3)_6]^{3+}$ (iii) $[\text{Fe}(\text{C}_2\text{O}_4)_3]^{3-}$ (iv) $[\text{FeCl}_6]^{3-}$
- 9.32** What will be the correct order for the wavelengths of absorption in the visible region for the following:
 $[\text{Ni}(\text{NO}_2)_6]^{4+}$, $[\text{Ni}(\text{NH}_3)_6]^{2+}$, $[\text{Ni}(\text{H}_2\text{O})_6]^{2+}$?

Answers to Some Intext Questions

- 9.1** (i) $[\text{Co}(\text{NH}_3)_4(\text{H}_2\text{O})_2]\text{Cl}_3$ (iv) $[\text{Pt}(\text{NH}_3)\text{BrCl}(\text{NO}_2)]$
 (ii) $\text{K}_2[\text{Ni}(\text{CN})_4]$ (v) $[\text{PtCl}_2(\text{en})_2](\text{NO}_3)_2$
 (iii) $[\text{Cr}(\text{en})_3]\text{Cl}_3$ (vi) $\text{Fe}_4[\text{Fe}(\text{CN})_6]_3$
- 9.2** (i) Hexaamminecobalt(III) chloride
 (ii) Pentaamminechloridocobalt(III) chloride
 (iii) Potassium hexacyanoferrate(III)
 (iv) Potassium trioxalatoferrate(III)
 (v) Potassium tetrachloridopalladate(II)
 (vi) Diamminechlorido(methylamine)platinum(II) chloride
- 9.3** (i) Both geometrical (*cis*-, *trans*-) and optical isomers for *cis* can exist.
 (ii) Two optical isomers can exist.
 (iii) There are 10 possible isomers. (Hint: There are geometrical, ionisation and linkage isomers possible).
 (iv) Geometrical (*cis*-, *trans*-) isomers can exist.
- 9.4** The ionisation isomers dissolve in water to yield different ions and thus react differently to various reagents:
 $[\text{Co}(\text{NH}_3)_5\text{Br}]\text{SO}_4 + \text{Ba}^{2+} \rightarrow \text{BaSO}_4 (\text{s})$
 $[\text{Co}(\text{NH}_3)_5\text{SO}_4]\text{Br} + \text{Ba}^{2+} \rightarrow \text{No reaction}$
 $[\text{Co}(\text{NH}_3)_5\text{Br}]\text{SO}_4 + \text{Ag}^+ \rightarrow \text{No reaction}$
 $[\text{Co}(\text{NH}_3)_5\text{SO}_4]\text{Br} + \text{Ag}^+ \rightarrow \text{AgBr} (\text{s})$
- 9.6** In $\text{Ni}(\text{CO})_4$, Ni is in zero oxidation state whereas in NiCl_4^{2-} , it is in +2 oxidation state. In the presence of CO ligand, the unpaired *d* electrons of Ni pair up but Cl^- being a weak ligand is unable to pair up the unpaired electrons.
- 9.7** In presence of CN^- , (a strong ligand) the 3*d* electrons pair up leaving only one unpaired electron. The hybridisation is d^2sp^3 forming inner orbital complex. In the presence of H_2O , (a weak ligand), 3*d* electrons do not pair up. The hybridisation is sp^3d^2 forming an outer orbital complex containing five unpaired electrons, it is strongly paramagnetic.
- 9.8** In the presence of NH_3 , the 3*d* electrons pair up leaving two *d* orbitals empty to be involved in d^2sp^3 hybridisation forming inner orbital complex in case of $[\text{Co}(\text{NH}_3)_6]^{3+}$.
 In $[\text{Ni}(\text{NH}_3)_6]^{2+}$, Ni is in +2 oxidation state and has d^8 configuration, the hybridisation involved is sp^3d^2 forming outer orbital complex.
- 9.9** For square planar shape, the hybridisation is dsp^2 . Hence the unpaired electrons in 5*d* orbital pair up to make one *d* orbital empty for dsp^2 hybridisation. Thus there is no unpaired electron.
- 9.11** The overall dissociation constant is the reciprocal of overall stability constant i.e. $1/\beta_4 = 4.7 \times 10^{-14}$

Answers to Some Questions in Exercises

UNIT 1

- 1.11 107.8 u
1.13 14.29 nm
1.15 8.97 g cm^{-3}
1.16 $\text{Ni}^{2+} = 96\%$ and $\text{Ni}^{3+} = 4\%$
1.24 (i) 354 pm (ii) 2.26×10^{22} unit cells
1.25 6.02×10^{18} cation vacancies mol^{-1}

UNIT 2

- 2.4 16.23 M
2.6 157.8 mL
2.8 17.95 m and 8.70 M
2.15 41.35 g mol^{-1}
2.17 12.08 kPa
2.19 34 g mol^{-1} , 3.4 kPa
2.21 A = 25.58 u and B = 42.64 u
2.24 KCl, CH_3OH , CH_3CN , Cyclohexane
2.25 Toluene, chloroform; Phenol, Pentanol; Formic acid, ethylene glycol
2.26 4 m
2.28 1.424%
2.30 4.575 g
2.33 $i = 1.0753$, $K_a = 3.07 \times 10^{-3}$
2.35 178×10^{-5}
2.38 0.675 and 0.325
2.40 0.03 mol
- 2.5 0.617 m, 0.01 and 0.99, 0.67
2.7 32% and 68%
2.9 $\sim 15 \times 10^{-4} \text{ g}$, $1.25 \times 10^{-4} \text{ m}$
2.16 73.08 kPa
2.18 8 g
2.20 269.07 K
2.22 0.061 M
2.27 $2.45 \times 10^{-8} \text{ M}$
2.29 3.2 g of water
2.32 0.65°
2.34 17.44 mm Hg
2.36 280.7 torr, 32 torr
2.39 $x(\text{O}_2) 4.6 \times 10^{-5}$, $x(\text{N}_2) 9.22 \times 10^{-5}$
2.41 $5.27 \times 10^{-3} \text{ atm}$.

UNIT 3

- 3.4 (i) $E^\ominus = 0.34\text{V}$, $\Delta_r G^\ominus = -196.86 \text{ kJ mol}^{-1}$, $K = 3.16 \times 10^{34}$
(ii) $E^\ominus = 0.03\text{V}$, $\Delta_r G^\ominus = -2.895 \text{ kJ mol}^{-1}$, $K = 3.2$
3.5 (i) 2.68 V, (ii) 0.53 V, (iii) 0.08 V, (iv) -1.315 V
3.6 1.105 V
3.8 $124.0 \text{ S cm}^2 \text{ mol}^{-1}$
3.9 0.219 cm^{-1}
3.11 1.85×10^{-5}
3.12 3F, 2F, 5F
3.13 1F, 4.44F
3.14 2F, 1F
3.15 1.803g
3.16 14.40 min, Copper 0.427g, Zinc 0.437 g

UNIT 4

- 4.2 (i) $8.0 \times 10^{-9} \text{ mol}^{-2} \text{ L}^2 \text{ s}^{-1}$; $3.89 \times 10^{-9} \text{ mol}^{-2} \text{ L}^2 \text{ s}^{-1}$
- 4.4 $\text{bar}^{-1/2} \text{ s}^{-1}$
- 4.6 (i) 4 times (ii) $\frac{1}{4}$ times
- 4.8 (i) $4.67 \times 10^{-3} \text{ mol L}^{-1} \text{ s}^{-1}$ (ii) $1.92 \times 10^{-2} \text{ s}^{-1}$
- 4.9 (i) rate = $k[A][B]^2$ (ii) 9 times
- 4.10 Orders with respect to A is 1.5 and order with respect to B is zero.
- 4.11 rate law = $k[A][B]^2$; rate constant = $6.0 \text{ M}^{-2} \text{ min}^{-1}$
- 4.13 (i) 3.47×10^{-3} seconds (ii) 0.35 minutes (iii) 0.173 years
- 4.14 1845 years 4.16 $4.6 \times 10^{-2} \text{ s}$
- 4.17 0.7842 μg and 0.227 μg . 4.19 77.7 minutes
- 4.20 $2.20 \times 10^{-3} \text{ s}^{-1}$ 4.21 $2.23 \times 10^{-3} \text{ s}^{-1}$, $7.8 \times 10^{-4} \text{ atm s}^{-1}$
- 4.23 $3.9 \times 10^{12} \text{ s}^{-1}$ 4.24 0.135 M
- 4.25 0.157 M 4.26 232.79 kJ mol^{-1}
- 4.27 239.339 kJ mol^{-1} 4.28 14°C
- 4.29 $E_a = 479.77 \text{ kJ mol}^{-1}$, $k = 5.70 \times 10^{-70} \text{ s}^{-1}$
- 4.30 52.8 kJ mol^{-1}

UNIT 6

- 6.1 Zinc is highly reactive metal, it may not be possible to replace it from a solution of ZnSO_4 so easily.
- 6.2 It prevents one of the components from forming the froth by complexation.
- 6.3 The Gibbs energies of formation of most sulphides are greater than that for CS_2 . In fact, CS_2 is an endothermic compound. Hence it is common practice to roast sulphide ores to corresponding oxides prior to reduction.
- 6.5 CO
- 6.6 Selenium, tellurium, silver, gold are the metals present in anode mud. This is because these are less reactive than copper.
- 6.9 Silica removes Fe_2O_3 remaining in the matte by forming silicate, FeSiO_3 .
- 6.15 Cast iron is made from pig iron by melting pig iron with scrap iron and coke. It has slightly lower carbon content ($\approx 3\%$) than pig iron ($\approx 4\%$ C)
- 6.17 To remove basic impurities, like Fe_2O_3
- 6.18 To lower the melting point of the mixture.
- 6.20 The reduction may require very high temperature if CO is used as a reducing agent in this case.
- 6.21 Yes, $2\text{Al} + \frac{3}{2}\text{O}_2 \rightarrow \text{Al}_2\text{O}_3 \quad \Delta_r G^\ominus = -827 \text{ kJ mol}^{-1}$
- $2\text{Al} + \frac{3}{2}\text{O}_2 \rightarrow \text{Al}_2\text{O}_3 \quad \Delta_r G^\ominus = -827 \text{ kJ mol}^{-1}$
- Hence $\text{Cr}_2\text{O}_3 + 2\text{Al} \rightarrow \text{Al}_2\text{O}_3 + 2\text{Cr} \quad -827 - (-540) = -287 \text{ kJ mol}^{-1}$
- 6.22 Carbon is better reducing agent.
- 6.25 Graphite rods act as anode and get burnt away as CO and CO_2 during the process of electrolysis.
- 6.28 Above 1600K Al can reduce MgO.

UNIT 7

- 7.10** Because of inability of nitrogen to expand its covalency beyond 4.
- 7.20** Freons
- 7.22** It dissolves in rain water and produces acid rain.
- 7.23** Due to strong tendency to accept electrons, halogens act as strong oxidising agent.
- 7.24** Due to high electronegativity and small size, it cannot act as central atom in higher oxoacids.
- 7.25** Oxygen has smaller size than chlorine. Smaller size favours hydrogen bonding.
- 7.30** Synthesis of O_2PtF_6 inspired Bartlett to prepare $XePtF_6$ as Xe and oxygen have nearly same ionisation enthalpies.
- 7.31** (i) +3 (ii) +3 (iii) -3 (iv) +5 (v) +5
- 7.34** ClF, Yes.
- 7.36** (i) $I_2 < F_2 < Br_2 < Cl_2$
(ii) $HF < HCl < HBr < HI$
(iii) $BiH_3 \leq SbH_3 < AsH_3 < PH_3 < NH_3$
- 7.37** (ii) NeF_2
- 7.38** (i) XeF_4
(ii) XeF_2
(iii) XeO_3

UNIT 8

- 8.2** It is because Mn^{2+} has $3d^5$ configuration which has extra stability.
- 8.5** Stable oxidation states.
 $3d^3$ (Vanadium): +2, +3, +4, and +5
 $3d^5$ (Chromium): +3, +4, +6
 $3d^5$ (Manganese): +2, +4, +6, +7
 $3d^8$ (Cobalt): +2, +3 (in complexes)
 $3d^4$ There is no d^4 configuration in the ground state.
- 8.6** Vanadate VO_3^- , chromate CrO_4^{2-} , permanganate MnO_4^-
- 8.10** +3 is the common oxidation state of the lanthanoids
In addition to +3, oxidation states +2 and +4 are also exhibited by some of the lanthanoids.
- 8.13** In transition elements the oxidation states vary from +1 to any highest oxidation state by one
For example, for manganese it may vary as +2, +3, +4, +5, +6, +7. In the nontransition elements the variation is selective, always differing by 2, e.g. +2, +4, or +3, +5 or +4, +6 etc.
- 8.18** Except Sc^{3+} , all others will be coloured in aqueous solution because of incompletely filled $3d$ -orbitals, will give rise to $d-d$ transitions.
- 8.21** (i) Cr^{2+} is reducing as it involves change from d^4 to d^3 , the latter is more stable configuration
(t_{2g}^3) $Mn(III)$ to $Mn(II)$ is from $3d^4$ to $3d^5$ again $3d^5$ is an extra stable configuration.
(ii) Due to CFSE, which more than compensates the 3rd IE.
(iii) The hydration or lattice energy more than compensates the ionisation enthalpy involved in removing electron from d^1 .
- 8.23** Copper, because with +1 oxidation state an extra stable configuration, $3d^{10}$ results.
- 8.24** Unpaired electrons $Mn^{3+} = 4$, $Cr^{3+} = 3$, $V^{3+} = 2$, $Ti^{3+} = 1$. Most stable Cr^{3+}
- 8.28** Second part 59, 95, 102.
- 8.30** Lawrencium, 103, +3

8.36 $Ti^{2+} = 2, V^{2+} = 3, Cr^{3+} = 3, Mn^{2+} = 5, Fe^{2+} = 6, Fe^{3+} = 5, CO^{2+} = 7, Ni^{2+} = 8, Cu^{2+} = 9$

8.38 $M\sqrt{n(n+2)} = 2.2, n \approx 1, d^2 sp^3, CN^-$ strong ligand

$= 5.3, n \approx 4, sp^3, d^2, H_2O$ weak ligand

$= 5.9, n \approx 5, sp^3, Cl^-$ weak ligand.

UNIT 9

9.5 (i) +3 (ii) +3 (iii) +2 (iv) +3 (v) +3

9.6 (i) $[Zn(OH)_4]^{2-}$ (ii) $K_2[PdCl_4]$ (iii) $[Pt(NH_3)_2Cl_2]$ (iv) $K_2[Ni(CN)_4]$

(v) $[Co(NH_3)_5(ONO)]^{2+}$ (vi) $[Co(NH_3)_6](SO_4)_3$ (vii) $K_3[Cr(C_2O_4)_3]$ (viii) $[Pt(NH_3)_6]^{4+}$

(ix) $[CuBr_4]^{2-}$ (x) $[Co(NH_3)_5(NO_2)]^{2+}$

9.9 (i) $[Cr(C_2O_4)_3]^{3-}$ - Nil

(ii) $[Co(NH_3)_3Cl_3]^-$ Two (*fac*- and *mer*-)

9.12 Three (two *cis* and one *trans*)

9.13 Aqueous $CuSO_4$ solution exists as $[Cu(H_2O)_4]SO_4$ which has blue colour due to $[Cu(H_2O)_4]^{2+}$ ions.

(i) When KF is added, the weak H_2O ligands are replaced by F^- ligands, forming $[CuF_4]^{2-}$ ions which is a green precipitate.



(ii) When KCl is added, Cl^- ligands replace the weak H_2O ligands forming $[CuCl_4]^{2-}$ ions which has bright green colour.

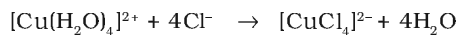

9.14 $[Cu(H_2O)_4]^{2+} + 4CN^- \rightarrow [Cu(CN)_4]^{2-} + 4H_2O$

As CN^- is a strong ligand, it forms a highly stable complex with Cu^{2+} ion. On passing H_2S , free Cu^{2+} ions are not available to form the precipitate of CuS .

9.23 (i) OS = +3, CN = 6, d-orbital occupation is $t_{2g}^6 e_g^0$,

(ii) OS = +3, CN = 6, $d^3 (t_{2g}^3)$,

(iii) OS = +2, CN = 4, $d^7 (t_{2g}^5 e_g^2)$,

(iv) OS = +2, CN = 6, $d^5 (t_{2g}^3 e_g^2)$.

9.28 (iii)

9.29 (ii)

9.30 (iii)

9.31 (iii)

9.32 (i) The order of the ligand in the spectrochemical series :



Hence the wavelength of the light observed will be in the order :



Thus, wavelengths absorbed ($E = hc/\lambda$) will be in the opposite order.

Elements, their Atomic Number and Molar Mass

Element	Symbol	Atomic Number	Molar mass/ (g mol ⁻¹)
Actinium	Ac	89	227.03
Aluminium	Al	13	26.98
Americium	Am	95	(243)
Antimony	Sb	51	121.75
Argon	Ar	18	39.95
Arsenic	As	33	74.92
Astatine	At	85	210
Barium	Ba	56	137.34
Berkelium	Bk	97	(247)
Beryllium	Be	4	9.01
Bismuth	Bi	83	208.98
Bohrium	Bh	107	(264)
Boron	B	5	10.81
Bromine	Br	35	79.91
Cadmium	Cd	48	112.40
Caesium	Cs	55	132.91
Calcium	Ca	20	40.08
Californium	Cf	98	251.08
Carbon	C	6	12.01
Cerium	Ce	58	140.12
Chlorine	Cl	17	35.45
Chromium	Cr	24	52.00
Cobalt	Co	27	58.93
Copper	Cu	29	63.54
Curium	Cm	96	247.07
Dubnium	Db	105	(263)
Dysprosium	Dy	66	162.50
Einsteinium	Es	99	(252)
Erbium	Er	68	167.26
Europium	Eu	63	151.96
Fermium	Fm	100	(257.10)
Fluorine	F	9	19.00
Francium	Fr	87	(223)
Gadolinium	Gd	64	157.25
Gallium	Ga	31	69.72
Germanium	Ge	32	72.61
Gold	Au	79	196.97
Hafnium	Hf	72	178.49
Hassium	Hs	108	(269)
Helium	He	2	4.00
Holmium	Ho	67	164.93
Hydrogen	H	1	1.0079
Indium	In	49	114.82
Iodine	I	53	126.90
Iridium	Ir	77	192.2
Iron	Fe	26	55.85
Krypton	Kr	36	83.80
Lanthanum	La	57	138.91
Lawrencium	Lr	103	(262.1)
Lead	Pb	82	207.19
Lithium	Li	3	6.94
Lutetium	Lu	71	174.96
Magnesium	Mg	12	24.31
Manganese	Mn	25	54.94
Meitneium	Mt	109	(268)
Mendelevium	Md	101	258.10

Element	Symbol	Atomic Number	Molar mass/ (g mol ⁻¹)
Mercury	Hg	80	200.59
Molybdenum	Mo	42	95.94
Neodymium	Nd	60	144.24
Neon	Ne	10	20.18
Neptunium	Np	93	(237.05)
Nickel	Ni	28	58.71
Niobium	Nb	41	92.91
Nitrogen	N	7	14.0067
Nobelium	No	102	(259)
Osmium	Os	76	190.2
Oxygen	O	8	16.00
Palladium	Pd	46	106.4
Phosphorus	P	15	30.97
Platinum	Pt	78	195.09
Plutonium	Pu	94	(244)
Polonium	Po	84	210
Potassium	K	19	39.10
Praseodymium	Pr	59	140.91
Promethium	Pm	61	(145)
Protactinium	Pa	91	231.04
Radium	Ra	88	(226)
Radon	Rn	86	(222)
Rhenium	Re	75	186.2
Rhodium	Rh	45	102.91
Rubidium	Rb	37	85.47
Ruthenium	Ru	44	101.07
Rutherfordium	Rf	104	(261)
Samarium	Sm	62	150.35
Scandium	Sc	21	44.96
Seaborgium	Sg	106	(266)
Selenium	Se	34	78.96
Silicon	Si	14	28.08
Silver	Ag	47	107.87
Sodium	Na	11	22.99
Strontium	Sr	38	87.62
Sulphur	S	16	32.06
Tantalum	Ta	73	180.95
Technetium	Tc	43	(98.91)
Tellurium	Te	52	127.60
Terbium	Tb	65	158.92
Thallium	Tl	81	204.37
Thorium	Th	90	232.04
Thulium	Tm	69	168.93
Tin	Sn	50	118.69
Titanium	Ti	22	47.88
Tungsten	W	74	183.85
Ununbium	Uub	112	(277)
Ununnilium	Uun	110	(269)
Ununonium	Uuu	111	(272)
Uranium	U	92	238.03
Vanadium	V	23	50.94
Xenon	Xe	54	131.30
Ytterbium	Yb	70	173.04
Yttrium	Y	39	88.91
Zinc	Zn	30	65.37
Zirconium	Zr	40	91.22

The value given in parenthesis is the molar mass of the isotope of largest known half-life.

Some Useful Conversion Factors

Common Unit of Mass and Weight

1 pound = 453.59 grams

1 pound = 453.59 grams = 0.45359 kilogram

1 kilogram = 1000 grams = 2.205 pounds

1 gram = 10 decigrams = 100 centigrams
= 1000 milligrams

1 gram = 6.022×10^{23} atomic mass units or u

1 atomic mass unit = 1.6606×10^{-24} gram

1 metric tonne = 1000 kilograms
= 2205 pounds

Common Unit of Volume

1 quart = 0.9463 litre

1 litre = 1.056 quarts

1 litre = 1 cubic decimetre = 1000 cubic centimetres = 0.001 cubic metre

1 millilitre = 1 cubic centimetre = 0.001 litre
= 1.056×10^{-3} quart

1 cubic foot = 28.316 litres = 29.902 quarts
= 7.475 gallons

Common Units of Energy

1 joule = 1×10^7 ergs

1 thermochemical calorie**

= 4.184 joules

= 4.184×10^7 ergs

= 4.129×10^{-2} litre-atmospheres

= 2.612×10^{19} electron volts

1 ergs = 1×10^{-7} joule = 2.3901×10^{-8} calorie

1 electron volt = 1.6022×10^{-19} joule
= 1.6022×10^{-12} erg
= 96.487 kJ/mol†

1 litre-atmosphere = 24.217 calories
= 101.32 joules
= 1.0132×10^9 ergs

1 British thermal unit = 1055.06 joules
= 1.05506×10^{10} ergs
= 252.2 calories

Common Units of Length

1 inch = 2.54 centimetres (exactly)

1 mile = 5280 feet = 1.609 kilometres

1 yard = 36 inches = 0.9144 metre

1 metre = 100 centimetres = 39.37 inches
= 3.281 feet

= 1.094 yards

1 kilometre = 1000 metres = 1094 yards

= 0.6215 mile

1 Angstrom = 1.0×10^{-8} centimetre

= 0.10 nanometre

= 1.0×10^{-10} metre

= 3.937×10^{-9} inch

Common Units of Force* and Pressure

1 atmosphere = 760 millimetres of mercury

= 1.013×10^5 pascals

= 14.70 pounds per square inch

1 bar = 10^5 pascals

1 torr = 1 millimetre of mercury

1 pascal = $1 \text{ kg/ms}^2 = 1 \text{ N/m}^2$

Temperature

SI Base Unit: Kelvin (K)

K = -273.15°C

K = $^\circ\text{C} + 273.15$

$^\circ\text{F} = 1.8(^\circ\text{C}) + 32$

$^\circ\text{C} = \frac{^\circ\text{F} - 32}{1.8}$

* Force: 1 newton (N) = 1 kg m/s^2 , i.e., the force that, when applied for 1 second, gives a 1-kilogram mass a velocity of 1 metre per second.

** The amount of heat required to raise the temperature of one gram of water from 14.5°C to 15.5°C .

† Note that the other units are per particle and must be multiplied by 6.022×10^{23} to be strictly comparable.

Standard potentials at 298 K in electrochemical order

Reduction half-reaction	E° / V	Reduction half-reaction	E° / V
$H_4XeO_6 + 2H^+ + 2e^- \longrightarrow XeO_3 + 3H_2O$	+3.0	$Cu^+ + e^- \longrightarrow Cu$	+0.52
$F_2 + 2e^- \longrightarrow 2F^-$	+2.87	$NiOOH + H_2O + e^- \longrightarrow Ni(OH)_2 + OH^-$	+0.49
$O_3 + 2H^+ + 2e^- \longrightarrow O_2 + H_2O$	+2.07	$Ag_2CrO_4 + 2e^- \longrightarrow 2Ag + CrO_4^{2-}$	+0.45
$S_2O_8^{2-} + 2e^- \longrightarrow 2SO_4^{2-}$	+2.05	$O_2 + 2H_2O + 4e^- \longrightarrow 4OH^-$	+0.40
$Ag^+ + e^- \longrightarrow Ag$	+1.98	$ClO_4^- + H_2O + 2e^- \longrightarrow ClO_3^- + 2OH^-$	+0.36
$Co^{3+} + e^- \longrightarrow Co^{2+}$	+1.81	$[Fe(CN)_6]^{3-} + e^- \longrightarrow [Fe(CN)_6]^{4-}$	+0.36
$H_2O_2 + 2H^+ + 2e^- \longrightarrow 2H_2O$	+1.78	$Cu^{2+} + 2e^- \longrightarrow Cu$	+0.34
$Au^+ + e^- \longrightarrow Au$	+1.69	$Hg_2Cl_2 + 2e^- \longrightarrow 2Hg + 2Cl^-$	+0.27
$Pb^{4+} + 2e^- \longrightarrow Pb^{2+}$	+1.67	$AgCl + e^- \longrightarrow Ag + Cl^-$	+0.27
$2HClO + 2H^+ + 2e^- \longrightarrow Cl_2 + 2H_2O$	+1.63	$Bi^{3+} + 3e^- \longrightarrow Bi$	+0.20
$Ce^{4+} + e^- \longrightarrow Ce^{3+}$	+1.61	$SO_4^{2-} + 4H^+ + 2e^- \longrightarrow H_2SO_3 + H_2O$	+0.17
$2HBrO + 2H^+ + 2e^- \longrightarrow Br_2 + 2H_2O$	+1.60	$Cu^{2+} + e^- \longrightarrow Cu^+$	+0.16
$MnO_4^- + 8H^+ + 5e^- \longrightarrow Mn^{2+} + 4H_2O$	+1.51	$Sn^{4+} + 2e^- \longrightarrow Sn^{2+}$	+0.15
$Mn^{3+} + e^- \longrightarrow Mn^{2+}$	+1.51	$AgBr + e^- \longrightarrow Ag + Br^-$	+0.07
$Au^{3+} + 3e^- \longrightarrow Au$	+1.40	$Ti^{4+} + e^- \longrightarrow Ti^{3+}$	0.00
$Cl_2 + 2e^- \longrightarrow 2Cl^-$	+1.36	$2H^+ + 2e^- \longrightarrow H_2$	0.0 by definition
$Cr_2O_7^{2-} + 14H^+ + 6e^- \longrightarrow 2Cr^{3+} + 7H_2O$	+1.33	$Fe^{3+} + 3e^- \longrightarrow Fe$	-0.04
$O_3 + H_2O + 2e^- \longrightarrow O_2 + 2OH^-$	+1.24	$O_2 + H_2O + 2e^- \longrightarrow HO_2^- + OH^-$	-0.08
$O_2 + 4H^+ + 4e^- \longrightarrow 2H_2O$	+1.23	$Pb^{2+} + 2e^- \longrightarrow Pb$	-0.13
$ClO_4^- + 2H^+ + 2e^- \longrightarrow ClO_3^- + 2H_2O$	+1.23	$In^+ + e^- \longrightarrow In$	-0.14
$MnO_2 + 4H^+ + 2e^- \longrightarrow Mn^{2+} + 2H_2O$	+1.23	$Sn^{2+} + 2e^- \longrightarrow Sn$	-0.14
$Pt^{2+} + 2e^- \longrightarrow Pt$	+1.20	$AgI + e^- \longrightarrow Ag + I^-$	-0.15
$Br_2 + 2e^- \longrightarrow 2Br^-$	+1.09	$Ni^{2+} + 2e^- \longrightarrow Ni$	-0.23
$Pu^{4+} + e^- \longrightarrow Pu^{3+}$	+0.97	$V^{3+} + e^- \longrightarrow V^{2+}$	-0.26
$NO_3^- + 4H^+ + 3e^- \longrightarrow NO + 2H_2O$	+0.96	$Co^{2+} + 2e^- \longrightarrow Co$	-0.28
$2Hg^{2+} + 2e^- \longrightarrow Hg_2^{2+}$	+0.92	$In^{3+} + 3e^- \longrightarrow In$	-0.34
$ClO^- + H_2O + 2e^- \longrightarrow Cl^- + 2OH^-$	+0.89	$Tl^+ + e^- \longrightarrow Tl$	-0.34
$Hg^{2+} + 2e^- \longrightarrow Hg$	+0.86	$PbSO_4 + 2e^- \longrightarrow Pb + SO_4^{2-}$	-0.36
$NO_3^- + 2H^+ + e^- \longrightarrow NO_2 + H_2O$	+0.80	$Ti^{3+} + e^- \longrightarrow Ti^{2+}$	-0.37
$Ag^+ + e^- \longrightarrow Ag$	+0.80	$Cd^{2+} + 2e^- \longrightarrow Cd$	-0.40
$Hg_2^{2+} + 2e^- \longrightarrow 2Hg$	+0.79	$In^{2+} + e^- \longrightarrow In^+$	-0.40
$Fe^{3+} + e^- \longrightarrow Fe^{2+}$	+0.77	$Cr^{3+} + e^- \longrightarrow Cr^{2+}$	-0.41
$BrO^- + H_2O + 2e^- \longrightarrow Br^- + 2OH^-$	+0.76	$Fe^{2+} + 2e^- \longrightarrow Fe$	-0.44
$Hg_2SO_4 + 2e^- \longrightarrow 2Hg + SO_4^{2-}$	+0.62	$In^{3+} + 2e^- \longrightarrow In^+$	-0.44
$MnO_4^{2-} + 2H_2O + 2e^- \longrightarrow MnO_2 + 4OH^-$	+0.60	$S + 2e^- \longrightarrow S^{2-}$	-0.48
$MnO_4^- + e^- \longrightarrow MnO_4^{2-}$	+0.56	$In^{3+} + e^- \longrightarrow In^{2+}$	-0.49
$I_2 + 2e^- \longrightarrow 2I^-$	+0.54	$U^{4+} + e^- \longrightarrow U^{3+}$	-0.61
$I_3^- + 2e^- \longrightarrow 3I^-$	+0.53	$Cr^{3+} + 3e^- \longrightarrow Cr$	-0.74
		$Zn^{2+} + 2e^- \longrightarrow Zn$	-0.76

(continued)

APPENDIX III CONTINUED

Reduction half-reaction	E°/V	Reduction half-reaction	E°/V
$\text{Cd}(\text{OH})_2 + 2e^- \longrightarrow \text{Cd} + 2\text{OH}^-$	-0.81	$\text{La}^{3+} + 3e^- \longrightarrow \text{La}$	-2.52
$2\text{H}_2\text{O} + 2e^- \longrightarrow \text{H}_2 + 2\text{OH}^-$	-0.83	$\text{Na}^+ + e^- \longrightarrow \text{Na}$	-2.71
$\text{Cr}^{2+} + 2e^- \longrightarrow \text{Cr}$	-0.91	$\text{Ca}^{2+} + 2e^- \longrightarrow \text{Ca}$	-2.87
$\text{Mn}^{2+} + 2e^- \longrightarrow \text{Mn}$	-1.18	$\text{Sr}^{2+} + 2e^- \longrightarrow \text{Sr}$	-2.89
$\text{V}^{2+} + 2e^- \longrightarrow \text{V}$	-1.19	$\text{Ba}^{2+} + 2e^- \longrightarrow \text{Ba}$	-2.91
$\text{Ti}^{2+} + 2e^- \longrightarrow \text{Ti}$	-1.63	$\text{Ra}^{2+} + 2e^- \longrightarrow \text{Ra}$	-2.92
$\text{Al}^{3+} + 3e^- \longrightarrow \text{Al}$	-1.66	$\text{Cs}^+ + e^- \longrightarrow \text{Cs}$	-2.92
$\text{U}^{3+} + 3e^- \longrightarrow \text{U}$	-1.79	$\text{Rb}^+ + e^- \longrightarrow \text{Rb}$	-2.93
$\text{Sc}^{3+} + 3e^- \longrightarrow \text{Sc}$	-2.09	$\text{K}^+ + e^- \longrightarrow \text{K}$	-2.93
$\text{Mg}^{2+} + 2e^- \longrightarrow \text{Mg}$	-2.36	$\text{Li}^+ + e^- \longrightarrow \text{Li}$	-3.05
$\text{Ce}^{3+} + 3e^- \longrightarrow \text{Ce}$	-2.48		

Logarithms

Sometimes, a numerical expression may involve multiplication, division or rational powers of large numbers. For such calculations, logarithms are very useful. They help us in making difficult calculations easy. In Chemistry, logarithm values are required in solving problems of chemical kinetics, thermodynamics, electrochemistry, etc. We shall first introduce this concept, and discuss the laws, which will have to be followed in working with logarithms, and then apply this technique to a number of problems to show how it makes difficult calculations simple.

We know that

$$2^3 = 8, 3^2 = 9, 5^3 = 125, 7^0 = 1$$

In general, for a positive real number a , and a rational number m , let $a^m = b$,

where b is a real number. In other words

the m^{th} power of base a is b .

Another way of stating the same fact is

logarithm of b to base a is m .

If for a positive real number a , $a \neq 1$

$$a^m = b,$$

we say that m is the logarithm of b to the base a .

We write this as $\log_a b = m$,

"log" being the abbreviation of the word "logarithm".

Thus, we have

$$\log_2 8 = 3, \quad \text{Since } 2^3 = 8$$

$$\log_3 9 = 2, \quad \text{Since } 3^2 = 9$$

$$\log \frac{125}{5} = 3, \quad \text{Since } 5^3 = 125$$

$$\log_7 1 = 0, \quad \text{Since } 7^0 = 1$$

Laws of Logarithms

In the following discussion, we shall take logarithms to any base a , ($a > 0$ and $a \neq 1$)

First Law: $\log_a (mn) = \log_a m + \log_a n$

Proof: Suppose that $\log_a m = x$ and $\log_a n = y$

Then $a^x = m$, $a^y = n$

Hence $mn = a^x \cdot a^y = a^{x+y}$

It now follows from the definition of logarithms that

$$\log_a (mn) = x + y = \log_a m + \log_a n$$

Second Law: $\log_a \left(\frac{m}{n} \right) = \log_a m - \log_a n$

Proof: Let $\log_a m = x$, $\log_a n = y$

Then $a^x = m$, $a^y = n$

$$\text{Hence } \frac{m}{n} = \frac{a^x}{a^y} = a^{x-y}$$

Therefore

$$\log_a \left(\frac{m}{n} \right) = x - y = \log_a m - \log_a n$$

Third Law : $\log_a(m^n) = n \log_a m$

Proof : As before, if $\log_a m = x$, then $a^x = m$

$$\text{Then } m^n = (a^x)^n = a^{nx}$$

giving $\log_a(m^n) = nx = n \log_a m$

Thus according to First Law: "the log of the product of two numbers is equal to the sum of their logs. Similarly, the Second Law says: the log of the ratio of two numbers is the difference of their logs. Thus, the use of these laws converts a problem of multiplication / division into a problem of addition/subtraction, which are far easier to perform than multiplication/division. That is why logarithms are so useful in all numerical computations.

Logarithms to Base 10

Because number 10 is the base of writing numbers, it is very convenient to use logarithms to the base 10. Some examples are:

$$\begin{aligned} \log_{10} 10 &= 1, & \text{since } 10^1 &= 10 \\ \log_{10} 100 &= 2, & \text{since } 10^2 &= 100 \\ \log_{10} 10000 &= 4, & \text{since } 10^4 &= 10000 \\ \log_{10} 0.01 &= -2, & \text{since } 10^{-2} &= 0.01 \\ \log_{10} 0.001 &= -3, & \text{since } 10^{-3} &= 0.001 \\ \text{and } \log_{10} 1 &= 0 & \text{since } 10^0 &= 1 \end{aligned}$$

The above results indicate that if n is an integral power of 10, i.e., 1 followed by several zeros or 1 preceded by several zeros immediately to the right of the decimal point, then $\log n$ can be easily found.

If n is not an integral power of 10, then it is not easy to calculate $\log n$. But mathematicians have made tables from which we can read off approximate value of the logarithm of any positive number between 1 and 10. And these are sufficient for us to calculate the logarithm of any number expressed in decimal form. For this purpose, we always express the given decimal as the product of an integral power of 10 and a number between 1 and 10.

Standard Form of Decimal

We can express any number in decimal form, as the product of (i) an integral power of 10, and (ii) a number between 1 and 10. Here are some examples:

(i) 25.2 lies between 10 and 100

$$25.2 = \frac{25.2}{10} \times 10 = 2.52 \times 10^1$$

(ii) 1038.4 lies between 1000 and 10000.

$$\therefore 1038.4 = \frac{1038.4}{1000} \times 10^3 = 1.0384 \times 10^3$$

(iii) 0.005 lies between 0.001 and 0.01

$$\therefore 0.005 = (0.005 \times 1000) \times 10^{-3} = 5.0 \times 10^{-3}$$

(iv) 0.00025 lies between 0.0001 and 0.001

$$\therefore 0.00025 = (0.00025 \times 10000) \times 10^{-4} = 2.5 \times 10^{-4}$$

In each case, we divide or multiply the decimal by a power of 10, to bring one non-zero digit to the left of the decimal point, and do the reverse operation by the same power of 10, indicated separately.

Thus, any positive decimal can be written in the form

$$n = m \times 10^p$$

where p is an integer (positive, zero or negative) and $1 \leq m < 10$. This is called the "standard form of n ."

Working Rule

1. Move the decimal point to the left, or to the right, as may be necessary, to bring one non-zero digit to the left of decimal point.
2. (i) If you move p places to the left, multiply by 10^p .
 (ii) If you move p places to the right, multiply by 10^{-p} .
 (iii) If you do not move the decimal point at all, multiply by 10^0 .
 (iv) Write the new decimal obtained by the power of 10 (of step 2) to obtain the standard form of the given decimal.

Characteristic and Mantissa

Consider the standard form of n

$$n = m \times 10^p, \text{ where } 1 \leq m < 10$$

Taking logarithms to the base 10 and using the laws of logarithms

$$\begin{aligned} \log n &= \log m + \log 10^p \\ &= \log m + p \log 10 \\ &= p + \log m \end{aligned}$$

Here p is an integer and as $1 \leq m < 10$, so $0 \leq \log m < 1$, i.e., m lies between 0 and 1. When $\log n$ has been expressed as $p + \log m$, where p is an integer and $0 \leq \log m < 1$, we say that p is the "characteristic" of $\log n$ and that $\log m$ is the "mantissa of $\log n$ ". Note that characteristic is always an integer – positive, negative or zero, and mantissa is never negative and is always less than 1. If we can find the characteristics and the mantissa of $\log n$, we have to just add them to get $\log n$.

Thus to find $\log n$, all we have to do is as follows:

1. Put n in the standard form, say
 $n = m \times 10^p, 1 \leq m < 10$
2. Read off the characteristic p of $\log n$ from this expression (exponent of 10).
3. Look up $\log m$ from tables, which is being explained below.
4. Write $\log n = p + \log m$

If the characteristic p of a number n is say, 2 and the mantissa is .4133, then we have $\log n = 2 + .4133$ which we can write as 2.4133. If, however, the characteristic p of a number m is say -2 and the mantissa is .4123, then we have $\log m = -2 + .4123$. We cannot write this as -2.4123. (Why?) In order to avoid this confusion we write $\bar{2}$ for -2 and thus we write $\log m = \bar{2}.4123$.

Now let us explain how to use the table of logarithms to find mantissas. A table is appended at the end of this Appendix.

Observe that in the table, every row starts with a two digit number, 10, 11, 12,... 97, 98, 99. Every column is headed by a one-digit number, 0, 1, 2, ...9. On the right, we have the section called "Mean differences" which has 9 columns headed by 1, 2...9.

	0	1	2	3	4	5	6	7	8	9	1	2	3	4	5	6	7	8	9
..
61	7853	7860	7868	7875	7882	7889	7896	7803	7810	7817	1	1	2	3	4	4	5	6	6
62	7924	7931	7935	7945	7954	7959	7966	7973	7980	7987	1	1	2	3	3	4	5	6	6
63	7993	8000	8007	8014	8021	8028	8035	8041	8048	8055	1	1	2	3	3	4	5	6	6

Now suppose we wish to find $\log(6.234)$. Then look into the row starting with 62. In this row, look

at the number in the column headed by 3. The number is 7945. This means that

$$\log (6.230) = 0.7945^*$$

But we want $\log (6.234)$. So our answer will be a little more than 0.7945. How much more? We look this up in the section on Mean differences. Since our fourth digit is 4, look under the column headed by 4 in the Mean difference section (in the row 62). We see the number 3 there. So add 3 to 7945. We get 7948. So we finally have

$$\log (6.234) = 0.7948.$$

Take another example. To find $\log (8.127)$, we look in the row 81 under column 2, and we find 9096. We continue in the same row and see that the mean difference under 7 is 4. Adding this to 9096, and we get 9100. So, $\log (8.127) = 0.9100$.

Finding N when $\log N$ is given

We have so far discussed the procedure for finding $\log n$ when a positive number n given. We now turn to its converse i.e., to find n when $\log n$ is given and give a method for this purpose. If $\log n = t$, we sometimes say $n = \text{antilog } t$. Therefore our task is given t , find its antilog. For this, we use the ready-made antilog tables.

Suppose $\log n = 2.5372$.

To find n , first take just the mantissa of $\log n$. In this case it is .5372. (Make sure it is positive.) Now take up antilog of this number in the antilog table which is to be used exactly like the log table. In the antilog table, the entry under column 7 in the row .53 is 3443 and the mean difference for the last digit 2 in that row is 2, so the table gives 3445. Hence,

$$\text{antilog } (.5372) = 3.445$$

Now since $\log n = 2.5372$, the characteristic of $\log n$ is 2. So the standard form of n is given by

$$n = 3.445 \times 10^2$$

$$\text{or } n = 344.5$$

Illustration 1:

If $\log x = 1.0712$, find x .

Solution: We find that the number corresponding to 0712 is 1179. Since characteristic of $\log x$ is 1, we have

$$\begin{aligned} x &= 1.179 \times 10^1 \\ &= 11.79 \end{aligned}$$

Illustration 2:

If $\log x = \bar{2}.1352$, find x .

Solution: From antilog tables, we find that the number corresponding to 1352 is 1366. Since the characteristic is $\bar{2}$ i.e., -2, so

$$x = 1.366 \times 10^{-2} = 0.01366$$

Use of Logarithms in Numerical Calculations

Illustration 1:

Find 6.3×1.29

Solution: Let $x = 6.3 \times 1.29$

$$\text{Then } \log x = \log (6.3 \times 1.29) = \log 6.3 + \log 1.29$$

Now,

$$\log 6.3 = 0.7993$$

$$\log 1.29 = 0.1106$$

$$\therefore \log x = 0.9099,$$

Taking antilog

* It should, however, be noted that the values given in the table are not exact. They are only approximate values, although we use the sign of equality which may give the impression that they are exact values. The same convention will be followed in respect of antilogarithm of a number.

$$x = 8.127$$

Illustration 2:

$$\text{Find } \frac{(1.23)^{1.5}}{11.2 \times 23.5}$$

$$\text{Solution: Let } x = \frac{(1.23)^{\frac{3}{2}}}{11.2 \times 23.5}$$

$$\text{Then } \log x = \log \frac{(1.23)^{\frac{3}{2}}}{11.2 \times 23.5}$$

$$= \frac{3}{2} \log 1.23 - \log (11.2 \times 23.5)$$

$$= \frac{3}{2} \log 1.23 - \log 11.2 - \log 23.5$$

Now,

$$\log 1.23 = 0.0899$$

$$\frac{3}{2} \log 1.23 = 0.13485$$

$$\log 11.2 = 1.0492$$

$$\log 23.5 = 1.3711$$

$$\log x = 0.13485 - 1.0492 - 1.3711$$

$$= \overline{3.71455}$$

$$\therefore x = 0.005183$$

Illustration 3:

$$\text{Find } \sqrt{\frac{(71.24)^5 \times \sqrt{56}}{(2.3)^7 \times \sqrt{21}}}$$

$$\text{Solution: Let } x = \sqrt{\frac{(71.24)^5 \times \sqrt{56}}{(2.3)^7 \times \sqrt{21}}}$$

$$\text{Then } \log x = \frac{1}{2} \log \left[\frac{(71.24)^5 \times \sqrt{56}}{(2.3)^7 \times \sqrt{21}} \right]$$

$$= \frac{1}{2} [\log (71.24)^5 + \log \sqrt{56} - \log (2.3)^7 - \log \sqrt{21}]$$

$$= \frac{5}{2} \log 71.24 + \frac{1}{4} \log 56 - \frac{7}{2} \log 2.3 - \frac{1}{4} \log 21$$

Now, using log tables

$$\log 71.24 = 1.8527$$

$$\log 56 = 1.7482$$

$$\log 2.3 = 0.3617$$

$$\log 21 = 1.3222$$

$$\therefore \log x = \frac{5}{2} \log (1.8527) + \frac{1}{4} (1.7482) - \frac{7}{2} (0.3617) - \frac{1}{4} (1.3222)$$

$$= 3.4723$$

$$\therefore x = 2967$$

LOGARITHMS

TABLE I

N	0	1	2	3	4	5	6	7	8	9	1	2	3	4	5	6	7	8	9
10	0000	0043	0086	0128	0170	0212	0253	0294	0334	0374	5	9	13	17	21	26	30	34	38
											4	8	12	16	20	24	28	32	36
11	0414	0453	0492	0531	0569	0607	0645	0682	0719	0755	4	8	12	16	20	23	27	31	35
											4	7	11	15	18	22	26	29	33
12	0792	0828	0864	0899	0934	0969	1004	1038	1072	1106	3	7	11	14	18	21	25	28	32
											3	7	10	14	17	20	24	27	31
13	1139	1173	1206	1239	1271	1303	1335	1367	1399	1430	3	6	10	13	16	19	23	26	29
											3	7	10	13	16	19	22	25	29
14	1461	1492	1523	1553	1584	1614	1644	1673	1703	1732	3	6	9	12	15	19	22	25	28
											3	6	9	12	14	17	20	23	26
15	1761	1790	1818	1847	1875	1903	1931	1959	1987	2014	3	6	9	11	14	17	20	23	26
											3	6	8	11	14	17	19	22	25
16	2041	2068	2095	2122	2148	2175	2201	2227	2253	2279	3	6	8	11	14	16	19	22	24
											3	5	8	10	13	16	18	21	23
17	2304	2330	2355	2380	2405	2430	2455	2480	2504	2529	3	5	8	10	13	15	18	20	23
											3	5	8	10	12	15	17	20	22
18	2553	2577	2601	2625	2648	2672	2695	2718	2742	2765	2	5	7	9	12	14	17	19	21
											2	4	7	9	11	14	16	18	21
19	2788	2810	2833	2856	2878	2900	2923	2945	2967	2989	2	4	7	9	11	13	16	18	20
											2	4	6	8	11	13	15	17	19
20	3010	3032	3054	3075	3096	3118	3139	3160	3181	3201	2	4	6	8	11	13	15	17	19
21	3222	3243	3263	3284	3304	3324	3345	3365	3385	3404	2	4	6	8	10	12	14	16	18
22	3424	3444	3464	3483	3502	3522	3541	3560	3579	3598	2	4	6	8	10	12	14	15	17
23	3617	3636	3655	3674	3692	3711	3729	3747	3766	3784	2	4	6	7	9	11	13	15	17
24	3802	3820	3838	3856	3874	3892	3909	3927	3945	3962	2	4	5	7	9	11	12	14	16
25	3979	3997	4014	4031	4048	4065	4082	4099	4116	4133	2	3	5	7	9	10	12	14	15
26	4150	4166	4183	4200	4216	4232	4249	4265	4281	4298	2	3	5	7	8	10	11	13	15
27	4314	4330	4346	4362	4378	4393	4409	4425	4440	4456	2	3	5	6	8	9	11	13	14
28	4472	4487	4502	4518	4533	4548	4564	4579	4594	4609	2	3	5	6	8	9	11	12	14
29	4624	4639	4654	4669	4683	4698	4713	4728	4742	4757	1	3	4	6	7	9	10	12	13
30	4771	4786	4800	4814	4829	4843	4857	4871	4886	4900	1	3	4	6	7	9	10	11	13
31	4914	4928	4942	4955	4969	4983	4997	5011	5024	5038	1	3	4	6	7	8	10	11	12
32	5051	5065	5079	5092	5105	5119	5132	5145	5159	5172	1	3	4	5	7	8	9	11	12
33	5185	5198	5211	5224	5237	5250	5263	5276	5289	5302	1	3	4	5	6	8	9	10	12
34	5315	5328	5340	5353	5366	5378	5391	5403	5416	5428	1	3	4	5	6	8	9	10	11
35	5441	5453	5465	5478	5490	5502	5514	5527	5539	5551	1	2	4	5	6	7	9	10	11
36	5563	5575	5587	5599	5611	5623	5635	5647	5658	5670	1	2	4	5	6	7	8	10	11
37	5682	5694	5705	5717	5729	5740	5752	5763	5775	5786	1	2	3	5	6	7	8	9	10
38	5798	5809	5821	5832	5843	5855	5866	5877	5888	5899	1	2	3	5	6	7	8	9	10
39	5911	5922	5933	5944	5955	5966	5977	5988	5999	6010	1	2	3	4	5	7	8	9	10
40	6021	6031	6042	6053	6064	6075	6085	6096	6107	6117	1	2	3	4	5	6	8	9	10
41	6128	6138	6149	6160	6170	6180	6191	6201	6212	6222	1	2	3	4	5	6	7	8	9
42	6232	6243	6253	6263	6274	6284	6294	6304	6314	6325	1	2	3	4	5	6	7	8	9
43	6335	6345	6355	6365	6375	6385	6395	6405	6415	6425	1	2	3	4	5	6	7	8	9
44	6435	6444	6454	6464	6474	6484	6493	6503	6513	6522	1	2	3	4	5	6	7	8	9
45	6532	6542	6551	6561	6471	6580	6590	6599	6609	6618	1	2	3	4	5	6	7	8	9
46	6628	6637	6646	6656	6665	6675	6684	6693	6702	6712	1	2	3	4	5	6	7	7	8
47	6721	6730	6739	6749	6758	6767	6776	6785	6794	6803	1	2	3	4	5	5	6	7	8
48	6812	6821	6830	6839	6848	6857	6866	6875	6884	6893	1	2	3	4	4	5	6	7	8
49	6902	6911	6920	6928	6937	6946	6955	6964	6972	6981	1	2	3	4	4	5	6	7	8

LOGARITHMS

TABLE 1 (Continued)

N	0	1	2	3	4	5	6	7	8	9	1	2	3	4	5	6	7	8	9
50	6990	6998	7007	7016	7024	7033	7042	7050	7059	7067	1	2	3	3	4	5	6	7	8
51	7076	7084	7093	7101	7110	7118	7126	7135	7143	7152	1	2	3	3	4	5	6	7	8
52	7160	7168	7177	7185	7193	7202	7210	7218	7226	7235	1	2	2	3	4	5	6	7	7
53	7243	7251	7259	7267	7275	7284	7292	7300	7308	7316	1	2	2	3	4	5	6	6	7
54	7324	7332	7340	7348	7356	7364	7372	7380	7388	7396	1	2	2	3	4	5	6	6	7
55	7404	7412	7419	7427	7435	7443	7451	7459	7466	7474	1	2	2	3	4	5	5	6	7
56	7482	7490	7497	7505	7513	7520	7528	7536	7543	7551	1	2	2	3	4	5	5	6	7
57	7559	7566	7574	7582	7589	7597	7604	7612	7619	7627	1	2	2	3	4	5	5	6	7
58	7634	7642	7649	7657	7664	7672	7679	7686	7694	7701	1	1	2	3	4	4	5	6	7
59	7709	7716	7723	7731	7738	7745	7752	7760	7767	7774	1	1	2	3	4	4	5	6	7
60	7782	7789	7796	7803	7810	7818	7825	7832	7839	7846	1	1	2	3	4	4	5	6	6
61	7853	7860	7868	7875	7882	7889	7896	7903	7910	7917	1	1	2	3	4	4	5	6	6
62	7924	7931	7938	7945	7952	7959	7966	7973	7980	7987	1	1	2	3	3	4	5	6	6
63	7993	8000	8007	8014	8021	8028	8035	8041	8048	8055	1	1	2	3	3	4	5	5	6
64	8062	8069	8075	8082	8089	8096	8102	8109	8116	8122	1	1	2	3	3	4	5	5	6
65	8129	8136	8142	8149	8156	8162	8169	8176	8182	8189	1	1	2	3	3	4	5	5	6
66	8195	8202	8209	8215	8222	8228	8235	8241	8248	8254	1	1	2	3	3	4	5	5	6
67	8261	8267	8274	8280	8287	8293	8299	8306	8312	8319	1	1	2	3	3	4	5	5	6
68	8325	8331	8338	8344	8351	8357	8363	8370	8376	8382	1	1	2	3	3	4	4	5	6
69	8388	8395	8401	8407	8414	8420	8426	8432	8439	8445	1	1	2	2	3	4	4	5	6
70	8451	8457	8463	8470	8476	8482	8488	8494	8500	8506	1	1	2	2	3	4	4	5	6
71	8513	8519	8525	8531	8537	8543	8549	8555	8561	8567	1	1	2	2	3	4	4	5	5
72	8573	8579	8585	8591	8597	8603	8609	8615	8621	8627	1	1	2	2	3	4	4	5	5
73	8633	8639	8645	8651	8657	8663	8669	8675	8681	8686	1	1	2	2	3	4	4	5	5
74	8692	8698	8704	8710	8716	8722	8727	8733	8739	8745	1	1	2	2	3	4	4	5	5
75	8751	8756	8762	8768	8774	8779	8785	8791	8797	8802	1	1	2	2	3	3	4	5	5
76	8808	8814	8820	8825	8831	8837	8842	8848	8854	8859	1	1	2	2	3	3	4	5	5
77	8865	8871	8876	8882	8887	8893	8899	8904	8910	8915	1	1	2	2	3	3	4	4	5
78	8921	8927	8932	8938	8943	8949	8954	8960	8965	8971	1	1	2	2	3	3	4	4	5
79	8976	8982	8987	8993	8998	9004	9009	9015	9020	9025	1	1	2	2	3	3	4	4	5
80	9031	9036	9042	9047	9053	9058	9063	9069	9074	9079	1	1	2	2	3	3	4	4	5
81	9085	9090	9096	9101	9106	9112	9117	9122	9128	9133	1	1	2	2	3	3	4	4	5
82	9138	9143	9149	9154	9159	9165	9170	9175	9180	9186	1	1	2	2	3	3	4	4	5
83	9191	9196	9201	9206	9212	9217	9222	9227	9232	9238	1	1	2	2	3	3	4	4	5
84	9243	9248	9253	9258	9263	9269	9274	9279	9284	9289	1	1	2	2	3	3	4	4	5
85	9294	9299	9304	9309	9315	9320	9325	9330	9335	9340	1	1	2	2	3	3	4	4	5
86	9345	9350	9355	9360	9365	9370	9375	9380	9385	9390	1	1	2	2	3	3	4	4	5
87	9395	9400	9405	9410	9415	9420	9425	9430	9435	9440	0	1	1	2	2	3	3	4	4
88	9445	9450	9455	9460	9465	9469	9474	9479	9484	9489	0	1	1	2	2	3	3	4	4
89	9494	9499	9504	9509	9513	9518	9523	9528	9533	9538	0	1	1	2	2	3	3	4	4
90	9542	9547	9552	9557	9562	9566	9571	9576	9581	9586	0	1	1	2	2	3	3	4	4
91	9590	9595	9600	9605	9609	9614	9619	9624	9628	9633	0	1	1	2	2	3	3	4	4
92	9638	9643	9647	9652	9657	9661	9666	9671	9675	9680	0	1	1	2	2	3	3	4	4
93	9685	9689	9694	9699	9703	9708	9713	9717	9722	9727	0	1	1	2	2	3	3	4	4
94	9731	9736	9741	9745	9750	9754	9759	9763	9768	9773	0	1	1	2	2	3	3	4	4
95	9777	9782	9786	9791	9795	9800	9805	9809	9814	9818	0	1	1	2	2	3	3	4	4
96	9823	9827	9832	9836	9841	9845	9850	9854	9859	9863	0	1	1	2	2	3	3	4	4
97	9868	9872	9877	9881	9886	9890	9894	9899	9903	9908	0	1	1	2	2	3	3	4	4
98	9912	9917	9921	9926	9930	9934	9939	9943	9948	9952	0	1	1	2	2	3	3	4	4
99	9956	9961	9965	9969	9974	9978	9983	9987	9992	9996	0	1	1	2	2	3	3	4	4

ANTILOGARITHMS

TABLE II

N	0	1	2	3	4	5	6	7	8	9	1	2	3	4	5	6	7	8	9
.00	1000	1002	1005	1007	1009	1012	1014	1016	1019	1021	0	0	1	1	1	1	2	2	2
.01	1023	1026	1028	1030	1033	1035	1038	1040	1042	1045	0	0	1	1	1	1	2	2	2
.02	1047	1050	1052	1054	1057	1059	1062	1064	1067	1069	0	0	1	1	1	1	2	2	2
.03	1072	1074	1076	1079	1081	1084	1086	1089	1091	1094	0	0	1	1	1	1	2	2	2
.04	1096	1099	1102	1104	1107	1109	1112	1114	1117	1119	0	1	1	1	1	2	2	2	2
.05	1122	1125	1127	1130	1132	1135	1138	1140	1143	1146	0	1	1	1	1	2	2	2	2
.06	1148	1151	1153	1156	1159	1161	1164	1167	1169	1172	0	1	1	1	1	2	2	2	2
.07	1175	1178	1180	1183	1186	1189	1191	1194	1197	1199	0	1	1	1	1	2	2	2	2
.08	1202	1205	1208	1211	1213	1216	1219	1222	1225	1227	0	1	1	1	1	2	2	2	3
.09	1230	1233	1236	1239	1242	1245	1247	1250	1253	1256	0	1	1	1	1	2	2	2	3
.10	1259	1262	1265	1268	1271	1274	1276	1279	1282	1285	0	1	1	1	1	2	2	2	3
.11	1288	1291	1294	1297	1300	1303	1306	1309	1312	1315	0	1	1	1	2	2	2	2	3
.12	1318	1321	1324	1327	1330	1334	1337	1340	1343	1346	0	1	1	1	2	2	2	2	3
.13	1349	1352	1355	1358	1361	1365	1368	1371	1374	1377	0	1	1	1	2	2	2	3	3
.14	1380	1384	1387	1390	1393	1396	1400	1403	1406	1409	0	1	1	1	2	2	2	3	3
.15	1413	1416	1419	1422	1426	1429	1432	1435	1439	1442	0	1	1	1	2	2	2	3	3
.16	1445	1449	1452	1455	1459	1462	1466	1469	1472	1476	0	1	1	1	2	2	2	3	3
.17	1479	1483	1486	1489	1493	1496	1500	1503	1507	1510	0	1	1	1	2	2	2	3	3
.18	1514	1517	1521	1524	1528	1531	1535	1538	1542	1545	0	1	1	1	2	2	2	3	3
.19	1549	1552	1556	1560	1563	1567	1570	1574	1578	1581	0	1	1	1	2	2	3	3	3
.20	1585	1589	1592	1596	1600	1603	1607	1611	1614	1618	0	1	1	1	2	2	3	3	3
.21	1622	1626	1629	1633	1637	1641	1644	1648	1652	1656	0	1	1	2	2	2	3	3	3
.22	1660	1663	1667	1671	1675	1679	1683	1687	1690	1694	0	1	1	2	2	2	3	3	3
.23	1698	1702	1706	1710	1714	1718	1722	1726	1730	1734	0	1	1	2	2	2	3	3	4
.24	1738	1742	1746	1750	1754	1758	1762	1766	1770	1774	0	1	1	2	2	2	3	3	4
.25	1778	1782	1786	1791	1795	1799	1803	1807	1811	1816	0	1	1	2	2	2	3	3	4
.26	1820	1824	1828	1832	1837	1841	1845	1849	1854	1858	0	1	1	2	2	3	3	3	4
.27	1862	1866	1871	1875	1879	1884	1888	1892	1897	1901	0	1	1	2	2	3	3	3	4
.28	1905	1910	1914	1919	1923	1928	1932	1936	1941	1945	0	1	1	2	2	3	3	4	4
.29	1950	1954	1959	1963	1968	1972	1977	1982	1986	1991	0	1	1	2	2	3	3	4	4
.30	1995	2000	2004	2009	2014	2018	2023	2028	2032	2037	0	1	1	2	2	3	3	4	4
.31	2042	2046	2051	2056	2061	2065	2070	2075	2080	2084	0	1	1	2	2	3	3	4	4
.32	2089	2094	2099	2104	2109	2113	2118	2123	2128	2133	0	1	1	2	2	3	3	4	4
.33	2138	2143	2148	2153	2158	2163	2168	2173	2178	2183	0	1	1	2	2	3	3	4	4
.34	2188	2193	2198	2203	2208	2213	2218	2223	2228	2234	1	1	2	2	3	3	4	4	5
.35	2239	2244	2249	2254	2259	2265	2270	2275	2280	2286	1	1	2	2	3	3	4	4	5
.36	2291	2296	2301	2307	2312	2317	2323	2328	2333	2339	1	1	2	2	3	3	4	4	5
.37	2344	2350	2355	2360	2366	2371	2377	2382	2388	2393	1	1	2	2	3	3	4	4	5
.38	2399	2404	2410	2415	2421	2427	2432	2438	2443	2449	1	1	2	2	3	3	4	4	5
.39	2455	2460	2466	2472	2477	2483	2489	2495	2500	2506	1	1	2	2	3	3	4	5	5
.40	2512	2518	2523	2529	2535	2541	2547	2553	2559	2564	1	1	2	2	3	4	4	5	5
.41	2570	2576	2582	2588	2594	2600	2606	2612	2618	2624	1	1	2	2	3	4	4	5	5
.42	2630	2636	2642	2649	2655	2661	2667	2673	2679	2685	1	1	2	2	3	4	4	5	6
.43	2692	2698	2704	2710	2716	2723	2729	2735	2742	2748	1	1	2	3	3	4	4	5	6
.44	2754	2761	2767	2773	2780	2786	2793	2799	2805	2812	1	1	2	3	3	4	4	5	6
.45	2818	2825	2831	2838	2844	2851	2858	2864	2871	2877	1	1	2	3	3	4	5	5	6
.46	2884	2891	2897	2904	2911	2917	2924	2931	2938	2944	1	1	2	3	3	4	5	5	6
.47	2951	2958	2965	2972	2979	2985	2992	2999	3006	3013	1	1	2	3	3	4	5	5	6
.48	3020	3027	3034	3041	3048	3055	3062	3069	3076	3083	1	1	2	3	3	4	5	6	6
.49	3090	3097	3105	3112	3119	3126	3133	3141	3148	3155	1	1	2	3	3	4	5	6	6

ANTILOGARITHMS

TABLE II (Continued)

N	0	1	2	3	4	5	6	7	8	9	1	2	3	4	5	6	7	8	9
.50	3162	3170	3177	3184	3192	3199	3206	3214	3221	3228	1	1	2	3	4	4	5	6	7
.51	3236	3243	3251	3258	3266	3273	3281	3289	3296	3304	1	2	2	3	4	5	5	6	7
.52	3311	3319	3327	3334	3342	3350	3357	3365	3373	3381	1	2	2	3	4	5	5	6	7
.53	3388	3396	3404	3412	3420	3428	3436	3443	3451	3459	1	2	2	3	4	5	6	6	7
.54	3467	3475	3483	3491	3499	3508	3516	3524	3532	3540	1	2	2	3	4	5	6	6	7
.55	3548	3556	3565	3573	3581	3589	3597	3606	3614	3622	1	2	2	3	4	5	6	7	7
.56	3631	3639	3648	3656	3664	3673	3681	3690	3698	3707	1	2	3	3	4	5	6	7	8
.57	3715	3724	3733	3741	3750	3758	3767	3776	3784	3793	1	2	3	3	4	5	6	7	8
.58	3802	3811	3819	3828	3837	3846	3855	3864	3873	3882	1	2	3	4	4	5	6	7	8
.59	3890	3899	3908	3917	3926	3936	3945	3954	3963	3972	1	2	3	4	5	5	6	7	8
.60	3981	3990	3999	4009	4018	4027	4036	4046	4055	4064	1	2	3	4	5	6	6	7	8
.61	4074	4083	4093	4102	4111	4121	4130	4140	4150	4159	1	2	3	4	5	6	7	8	9
.62	4169	4178	4188	4198	4207	4217	4227	4236	4246	4256	1	2	3	4	5	6	7	8	9
.63	4266	4276	4285	4295	4305	4315	4325	4335	4345	4355	1	2	3	4	5	6	7	8	9
.64	4365	4375	4385	4395	4406	4416	4426	4436	4446	4457	1	2	3	4	5	6	7	8	9
.65	4467	4477	4487	4498	4508	4519	4529	4539	4550	4560	1	2	3	4	5	6	7	8	9
.66	4571	4581	4592	4603	4613	4624	4634	4645	4656	4667	1	2	3	4	5	6	7	9	10
.67	4677	4688	4699	4710	4721	4732	4742	4753	4764	4775	1	2	3	4	5	7	8	9	10
.68	4786	4797	4808	4819	4831	4842	4853	4864	4875	4887	1	2	3	4	6	7	8	9	10
.69	4898	4909	4920	4932	4943	4955	4966	4977	4989	5000	1	2	3	5	6	7	8	9	10
.70	5012	5023	5035	5047	5058	5070	5082	5093	5105	5117	1	2	4	5	6	7	8	9	11
.71	5129	5140	5152	5164	5176	5188	5200	5212	5224	5236	1	2	4	5	6	7	8	10	11
.72	5248	5260	5272	5284	5297	5309	5321	5333	5346	5358	1	2	4	5	6	7	9	10	11
.73	5370	5383	5395	5408	5420	5433	5445	5458	5470	5483	1	3	4	5	6	8	9	10	11
.74	5495	5508	5521	5534	5546	5559	5572	5585	5598	5610	1	3	4	5	6	8	9	10	12
.75	5623	5636	5649	5662	5675	5689	5702	5715	5728	5741	1	3	4	5	7	8	9	10	12
.76	5754	5768	5781	5794	5808	5821	5834	5848	5861	5875	1	3	4	5	7	8	9	11	12
.77	5888	5902	5916	5929	5943	5957	5970	5984	5998	6012	1	3	4	5	7	8	10	11	12
.78	6026	6039	6053	6067	6081	6095	6109	6124	6138	6152	1	3	4	6	7	8	10	11	13
.79	6166	6180	6194	6209	6223	6237	6252	6266	6281	6295	1	3	4	6	7	9	10	11	13
.80	6310	6324	6339	6353	6368	6383	6397	6412	6427	6442	1	3	4	6	7	9	10	12	13
.81	6457	6471	6486	6501	6516	6531	6546	6561	6577	6592	2	3	5	6	8	9	11	12	14
.82	6607	6622	6637	6653	6668	6683	6699	6714	6730	6745	2	3	5	6	8	9	11	12	14
.83	6761	6776	6792	6808	6823	6839	6855	6871	6887	6902	2	3	5	6	8	9	11	13	14
.84	6918	6934	6950	6966	6982	6998	7015	7031	7047	7063	2	3	5	6	8	10	11	13	15
.85	7079	7096	7112	7129	7145	7161	7178	7194	7211	7228	2	3	5	7	8	10	12	13	15
.86	7244	7261	7278	7295	7311	7328	7345	7362	7379	7396	2	3	5	7	8	10	12	13	15
.87	7413	7430	7447	7464	7482	7499	7516	7534	7551	7568	2	3	5	7	9	10	12	14	16
.88	7586	7603	7621	7638	7656	7674	7691	7709	7727	7745	2	4	5	7	9	11	12	14	16
.89	7762	7780	7798	7816	7834	7852	7870	7889	7907	7925	2	4	5	7	9	11	13	14	16
.90	7943	7962	7980	7998	8017	8035	8054	8072	8091	8110	2	4	6	7	9	11	13	15	17
.91	8128	8147	8166	8185	8204	8222	8241	8260	8279	8299	2	4	6	8	9	11	13	15	17
.92	8318	8337	8356	8375	8395	8414	8433	8453	8472	8492	2	4	6	8	10	12	14	15	17
.93	8511	8531	8551	8570	8590	8610	8630	8650	8670	8690	2	4	6	8	10	12	14	16	18
.94	8710	8730	8750	8770	8790	8810	8831	8851	8872	8892	2	4	6	8	10	12	14	16	18
.95	8913	8933	8954	8974	8995	9016	9036	9057	9078	9099	2	4	6	8	10	12	15	17	19
.96	9120	9141	9162	9183	9204	9226	9247	9268	9290	9311	2	4	6	8	11	13	15	17	19
.97	9333	9354	9376	9397	9419	9441	9462	9484	9506	9528	2	4	7	9	11	13	15	17	20
.98	9550	9572	9594	9616	9638	9661	9683	9705	9727	9750	2	4	7	9	11	13	16	18	20
.99	9772	9795	9817	9840	9863	9886	9908	9931	9954	9977	2	5	7	9	11	14	16	18	20

INDEX

Terms	Page No.	Terms	Page No.
Absorption	122	Collision frequency	115
Actinoid contraction	231	Collision theory of chemical reactions	115
Actinoids	209, 230	Column chromatography	161
Activated complex	112	Concentration of ores	149, 150
Activators	132	Concentration of solutions	34
Activation energy	113	Conductivity	73, 79
Adsorption	122	Conductors	24
Adsorption isotherm	125	Coordination compounds	237
Allotropic forms	175, 187	Coordination entity	240, 242
Ambidentate ligand	240	Coordination isomerism	246
Amorphous solids	2	Coordination number	12
Anisotropic	3	Coordination polyhedron	241
Anomalous behaviour of oxygen	182	Coordination theory	239
Antiferromagnetism	28	Copper matte	151, 156
Aqua regia	199	Corrosion	89
Arrhenius equation	111, 113	Cryoscopic constant	51
Atomic radii	166, 181, 193, 203	Crystal defects	22
Average rate	95	Crystal field splitting	251, 252
Avogadro constant	20	Crystal field theory	247, 250
Azeotrope	46, 47	Crystal lattice	7
Batteries	86	Crystalline solids	2, 3, 4
Binary solutions	33, 41, 44	Dalton's law	41
Biochemical catalysis	131	Daniell cell	64
Black phosphorus	176	Denticity	240
Blast furnace	154, 156, 157	Dependence on rate of concentration	98
Blister copper	157	Depressants	149
Body-centred unit	7, 11	Dialyser	138
Bohr magneton	27, 221	Dialysis	138
Bonding in metal carbonyls	254	Diamagnetism	28, 220
Bravais lattices	7	Didentate	240
Bredig's arc	137	Diode	27
Brown ring test	175	Dislocation defect	23
Brownian movement	140	Dispersed phase	134, 135
Calcination	150, 154	Dispersion medium	134, 135
Cast iron	156, 162	Dissociation constant	256
Catalyst	114, 128	Distillation	159
Cell potential	66	Ebullioscopic constant	49
Chelate	240	Electrical conductance	74
Chemical kinetics	93	Electro dialysis	138
Chemisorption	123	Electrochemical cells	64
Chiral	245	Electrochemistry	63
Chromatographic methods	160	Electrode potential	66, 218, 220
Cis - isomer	244, 245	Electrolytes	79
Classification of colloids	134	Electrolytic cell	83
Close-packed structures	12	Electrolytic refining	159
Coagulation	142	Electromotive force	66
Colligative properties	47, 56	Electron hole	26

Terms	Page No.	Terms	Page No.
Electron vacancy	26	Hydrogen bonded molecular solids	4
Electronegativity	167, 181, 193	Ideal solution	45
Electronic configuration	210	Impurity defect	23
Electronic defect	26	Inhibitors	132
Electroosmosis	142	Inner transition metals	209, 227
Elements	147	Instability constant	256
Ellingham diagram	152	Instantaneous rate of a reaction	96, 97
Eluant	161	Insulators	25
Empirical formula	238	Inter molecular forces	2
Emulsions	135, 143	Interstitial compounds	223
Enantiomers	245	Interstitial defect	22
End-centred unit	8	Intrinsic semiconductors	25
Enthalpy	124	Ionic conductance	75
Enzyme catalysis	131, 132	Ionic radii	166, 181, 193
Equilibrium constant	71	Ionic solids	5
f.- block elements	227	Ionisation enthalpy	166, 181, 193, 203
Face centred unit	7, 11	Ionisation isomerism	246
Facial isomer	245	Isomerism	244
Faraday's law	83	Isotonic solution	54
Ferrimagnetism	28	Kinetic energy	113
Ferromagnetism	28, 221	Kohlrausch law	81, 82
First order reaction	104, 109	Kraft temperature	136
Froth floatation	149	Lanthanide contraction	213, 228
Fractional distillation	169	Lanthanoids	209, 227
Frenkel defect	22, 23	Le Chateliers principle	38
Frequency factor	111	Leaching	150
Freundlich isotherm	125	Lewis acids	240
Fuel cells	88	Ligand field theory	247
Galvanic cell	64, 65, 89	Ligands	222, 240
Gangue	147, 148	Line defects	22
Gels	135	Linkage isomerism	248
Geometric isomerism	244	Liquation	161
Giant molecules	5	Long range order	2
Gibbs energy	65, 72, 117	Lyophilic colloids	137
Haber's process	128	Lyophobic colloids	137
Half-life	108	Magnetic separation	151
Hall heroult process	158	Meridional isomer	247
Halogens	192	Metal carbonyls	256
Henry's law	40	Metal excess defect	23
Heterogeneous catalysis	128, 129	Metallic solids	5
Heteroleptic complex	241	Metallurgy	149, 153
Holme's signals	176	Micelles	138
Homogeneous catalysis	128	Minerals	149
Homoleptic complex	241, 254	Mischmetall	232
Hybridisation	248	Molal elevation constant	49
Hydrate isomerism	249	Molality	37
Hydration enthalpy	217	Molar conductivity	79
Hydraulic washing	148	Molarity	36, 53
Hydro metallurgy	158	Mole fraction	35, 48

Terms	Page No.	Terms	Page No.
Molecular orbital theory	249	Schottky defect	22, 23
Molecularity of a reaction	104	Secondary battery	87
Mond process	162	Secondary valence	237, 238
Monoclinic sulphur	189	Semi conductors	25
Mononuclear coordination compounds	244	Semipermeable membrane	53
Nernst equation	70	Shape-selective catalysis	130
Noble gases	204	Short range order	2
Non-ideal solution	45	Smoke screens	176
Non-polar molecular solids	4	Solid state	2
Octahedral voids	15, 17	Sols	135
Optical isomerism	245	Solubility	37
Order of a reaction	100	Solvate isomerism	247
Ores	148	Stereo isomerism	244
Osmotic pressure	53	Stoichiometric defect	22
Ostwald's process	129	Strong field ligands	251
Oxidation number	241	Structural isomerism	244
Oxidation state	194	Super cooled liquids	3
Oxides of nitrogen	172	Surface chemistry	121
Oxoacids of halogens	199	Temperature dependence of rate	111
Oxoacids of phosphorus	178, 179	Tetrahedral permanganate	226
Oxoacids of sulphur	189	Tetrahedral voids	14, 16
Ozone	185	Thermodynamics	154
Packing efficiency	18	Trans isomer	244
Paper chromatography	161	Transition metals	209, 212
Paramagnetism	27, 220	Tyndall cone	139
p-block elements	165	Tyndall effect	139
Peptization	138	Ultrafiltration	139
Physisorption	123	Unidentate	240
Pig iron	156	Unit cells	7, 10
Point defects	22	Units of rate constant	101
Polar molecular solids	4	Units of rate of a reaction	95
Polydentate	240	Vacancy defect	22
Primary battery	86	Valence bond theory	247, 250
Primary valence	237	Van arkel method	160
Pseudo first order reaction	110	Vapour phase refining	160
Pseudo solids	3	Vapour pressure	42, 44
Purification of metal	147	Voltaic cell	64
Pyrometallurgy	151, 157	Weak field ligands	251
Raoult's law	41, 44	Werner's theory	237, 239
Rate law	98, 99	Wheatstone bridge	73, 75
Reaction rate constant	99	White phosphorus	175
Redox couples	65	Wrought iron	156, 162
Red phosphorus	175	Zeolites	130, 131
Reverberatory furnace	151, 156	Zero order Reaction	103, 109
Reverse osmosis	55	Zeta potential	141
Rhombic sulphur	187	Zone refining	159, 160
Roasting	151, 154		